



**Bike** *it* **.co.uk**

**ROAD**

**ISSUE 13**

[WWW.BIKEIT.CO.UK](http://WWW.BIKEIT.CO.UK)

The [www.bikeit.co.uk](http://www.bikeit.co.uk) website provides a wealth of resources to keep you fully updated of Bike It products, news, sponsorship and distribution.

## Online Catalogue



Browse the latest catalogue page by page, free and easy access.

## Retail Outlets

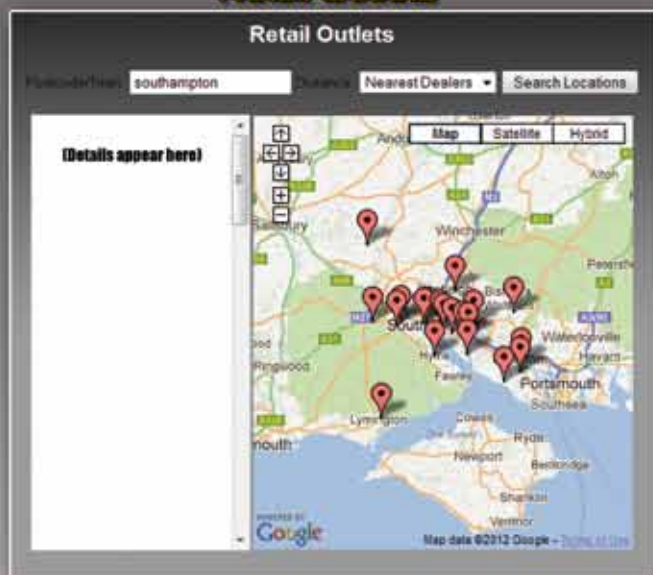

Google location search facility showing the nearest Bike It retail stockist

**News & PR**  
See what's been happening in the news, magazine articles and features.

**flickr**  
See Bike It products in use - photos submitted by Bike It customers. If you have any photos you wish to send in, email them to [flickr@bikeit.co.uk](mailto:flickr@bikeit.co.uk)



## New Releases



Features every new product released during the season - never miss out on the latest product launches

## Downloads



A fantastic resource offers downloads of fitting-instructions and product application guides



# Online Trade Ordering

<http://store.bikeit.co.uk>

Join our many trade customers now enjoying the benefits of online ordering.

- > Simple to use and time-saving
- > Product search function, quickly locates required item.
- > 'Quick order entry'.
- > Automated email transaction acknowledgement
- > Viewable order history, reorder or amend previous orders

Existing Bike It customers should contact their Field/Account Manager to activate their account



## Contents

MotoGP	16-28
Exhausts	29-47
Screens	48-54
Commuter	55-70
Controls	71-102
Headlights	103-111
Indicators	112-125
Mirrors	126-140
Rear Lights	141-151
Lifts & Stands	152-161
Tools	162-189
Batteries & Chargers	190-195

Electrics	196-198
Chain	199-213
Servicing	214-236
Tyres & Tubes	237-243
Security	244-252
Bike Accessories	253-273
Luggage	274-279
Rider Accessories	280-293
Tank Pads	294-296
Extras	297-315

[www.bikeit.co.uk](http://www.bikeit.co.uk)



# Español

Estimado cliente Bike It,

Esta es su copia personal del catálogo Bikelit 2013, que tiene dos frentes. Esta es la Sección de ROAD (Calle), pero si vuelve el catálogo, usted tendrá todos los ítems relacionados con el motocross que se encuentran en la sección OFF ROAD. Nos gustaría darle algunos consejos para un uso más fácil. Los precios de compra no se encuentran en el catálogo, pero en una lista separadamente impresa, un CD, ó por correo electrónico con un archivo de Excel. Nos gustaría informarlo que Bike It ofrece tarifas muy competitivas y que en muchos países de la UE las entregas gratis son bien posibles, haciendo un pedido de valor mínimo, puede consultar la nuestra tabla de pedidos mínimos para portes gratis.



Hace casi 2 años que Bike It está ofreciendo a través de la página web ya renovada, este catálogo en forma de libro. También ofrecemos a los clientes finales la posibilidad de encontrar los nuestros distribuidores más cercanos en nuestro buscador de distribuidores. El distribuidor puede hacer los pedidos directamente en la web, asegurado por su nombre de usuario y su contraseña. Con la búsqueda fácil tendrá toda la información necesaria, entrada rápida de sus pedidos, la confirmación por correo electrónico, historial de pedidos, stock actualizado... Miren la hoja 2 y 3 de este catálogo pues tiene más información del web site. Todavía no está a utilizar los pedidos directos en la web? Por favor hable con su agente Bike It local ó pidan a (la Oficina Europea, a la Oficina Ibérica) para obtener ayuda. Le deseamos que sea un placer para usted las comprar con nuestro catálogo.

## Indice

<b>Artículos MotoGP</b>	16-28
<b>Escapes</b>	29-47
<b>Cupula Y Pantallas</b>	48-54
<b>Scooter</b>	55-70
<b>Manetas, Puños</b>	71-102
<b>Faros Delanteros</b>	103-111
<b>Intermitentes</b>	112-125
<b>Espejos</b>	126-140
<b>Faros Traseros</b>	141-151
<b>Caballetes Y Mesas Elevadoras</b>	152-161
<b>Herramientas</b>	162-189
<b>Baterías Y Cargadores</b>	190-195

<b>Electronica</b>	196-198
<b>Cadenas</b>	199-213
<b>Filtros Y Pastillas Freno</b>	214-236
<b>Neumaticos Y Accesorios</b>	237-243
<b>Seguridad</b>	244-252
<b>Fundas Moto Y Accesorios</b>	253-273
<b>Bolsas Y Accesorios</b>	274-279
<b>Boutique Y Accesorios</b>	280-293
<b>Protectores Deposito</b>	294-296
<b>Diversos</b>	297-315

**www.bikeit.co.uk**



<b>A</b>	<b>PÁGINA</b>				
Acido Bateria	192	Cinta Adhesiva de	187	Herramienta para	165
Adaptadores de Espejo	140	Aislamiento		Bujías	
Adhesivo de Pantalla –	23	Cinta para Maneta	189	Herramientas de	182
MotoGP		Cintas Adesivas LED	271	Carburador	
Adhesivo p/Llantas	242	Cintas de Soporte	188	Herramientas p/	180
Ajustador de Cables	91	Cintas para Llantas de	243	Cadena	
Alambre	179	Moto		Herramientas para	184
Alarmer de garage	252	Cola de Puño	90	Amortiguador	
Alarmas de Moto	252	Collares Porta	27	Herramientas para	170
Alcancia	303	Identificacion		Valvula	
Alfombra de Garage	300-301	Conector de Cable	197	<b>I</b>	
Alfombras de Puerta	299	Bujia		Intercomunicadores	293
Alforgas	275	Conectores Escape	32-43	Intermitentes	112-123
Almohadillas de puño	91	Contrapesos	86-87	Interruptor de presión	197
Amortiguador	236	Control de Cruzero	87	de aceite	
Amortiguador de	255	Correa de Manillar	189	Interruptores	198
Direccion		Cubre Piernas	273	Interruptores	198
Anclaje de Cinta	188	Cubrebotas	292	Interruptores de	198
Anclaje de Suelo	245-247	Cuello – MotoGP	23	Embrague	
Antirrobo	247-251	Cuenta Kilometros	263	<b>J</b>	
Antirrobo en U	247-251	Cupulas	49-53	Jeringas	184
Antirrobo	245-249	<b>D</b>		Juntas de Escape	44
Aplicaciones de Cupula	54	Deposito de Fluidos	168	<b>K</b>	
Asa para Acompañante	292	Deposito Gasolina	169	Kit de Emergencia	278
Asiento de Mecanico	175	Desacoplador Rapido	225	Kit de Polimiento	163
Avisador Antirrobo de	251	p/M.Gasolina		Kit de Reparacion de	179
Disco		Deslizaderas –	23	Cables	
<b>B</b>		MotoGP		Kit de Reparacion	172
Banco de Rodillos	160	Desmontadores	170	Neumaticos	
Bandera	297	Manuales		Kit de Tornillos	263
Baterias	190-193	Diablos	156	Kit de Transmicion	203-213
Baterias Litio	190	Diablos	156	Kit Primeros Auxilios	293
Bidon de Aceite	169	Diablos	156	Kit Primeros Auxilios	288
Bidon de Aceite Usado	169	Disco Freno	220-224	Kits de Sangrado	168
Bidon de Gasolina	169	<b>E</b>		<b>L</b>	
Bidone – MotoGP	25	Elasticos de Transporte	279	Lamparas	111
Bidones de Gasolina	169	Elevador de Moto	152	Lap Timer	315
Bobinas de Incendio	197	Elevador Intermitentes	115	Lazos Cables Nylon	178
Bocina de Aire	303	Carenado		Limpiador de Pantalla	290
Bocinas	196	Elevadora Custom	159	Linterna Electrica	303
Bolsa de Agua	278	Embudo	169	Linterna Mecanica LED	178
Bolsa de Casco	279	Embudo Aceite	169	Llave de Eje Axle	171
Bolsa de Deposito	277	Embudo para Acido	195	Llave Filtro Aceite	174
Bolsa para GPS	274	Enchufe de Mechero	315	Llaveros	304-305
Bolsas	276	Enganches Rapidos	156	Llaves Allen	176
Bolsas GPS	274	Equilibradora de	171	Llaves Allen	177
Bomba de Pie	173	Neumatico		Lubrificante de Cable	179
Braga Cuello	291	Escape Universal	45	Lubrificante de Cadena	162
Bujía	235	Escapes	32-43	Luz de Aparcamiento	111
Bujías NGK	235	Escapes 2 Brothers	29	<b>M</b>	
<b>C</b>		Espaciador de Tubo	179	Maletas	276
Caballote com Ruedas	160	Espaciadores	124	Manetas	92-102
Caballote de	160	Intermitentes		Manguera Gasolina	225
Transporte		Espejos	126-139	Manillares	84-85
Caballote	157	Estante de Casco	299	Manómetros de	173
Estacionamiento		Estriberas	259-262	Presion	
Ajustable		<b>F</b>		Maquina Lavar	167
Caballote Fijo	153	Faja	292	Maquina Lavar alta	167
Caballote Hidraulico	161	Faro Cromado	103-109	presion	
Caballote Hidraulico	159	Faros Delanteros	109	Marcador Blanco para	243
Caballote Trasero con	152	Faros traseros en LED	141-149	Neumaticos	
3 Ruedas		Filtros de Aceite	227-230	Mascara	291
Caballetes	153-155	Filtros de Aire Calle	232-234	Mascara – MotoGP	22
Cables Bateria	195	Filtros de Aire Care Kit	235	Medidor	169
Cadena	200-202	Filtros de Gasolina	225	Medidor de Bateria	195
Caja Herramientas	185	Funda de ATV	272	Medidores de Presion	182
Calcetines – MotoGP	24	Funda de mobile	274	Medidores Presion –	18
Calentador de Manos	293	Funda de Neumatico	253	MotoGP	
Calentador de Rodilla	292	Funda de Puños	91	Mesa	299
Calentadores	253	Funda Moto	272-273	Mesa Elevadora	161
Calibrador	176	Funda p/ Polvo	272	Mochila	278
Calzo Anti-vuelco	271	Funda p/ Polvo	272	Moleta de Arreglo de	258
Caballote		Fusibles	197	Horquilla	
Calzoncillos – MotoGP	24	<b>G</b>		Monoplas Cubremanos	84
Cámara	281	Gafas de Sol	305	<b>N</b>	
Camaras de Aire	242	Ganchos de Transporte	279	Neopreno - MotoGP	22
Camisetas Paddock	287	Guantes	282-283	Neumaticos	237-239
Carenados Delanteros	103-105	Guantes de Mecanico	163	<b>P</b>	
Cargadores Baterias	194	Guia de Cables	91	Paraguas – MotoGP	28
Carpas	302	<b>H</b>		Pastillas Freno C-PRO	215-218
Cascos Modulares	280	Herramienta P/ Bomba	179	Pegatinas	28
Chalecos Refletantes	289	Freno		Pesos	242
		Herramienta P/	182	Pinza Amperometrica	179
		Carburador		Digital	



# Italiano

Caro Cliente Bike It, questo è la tua copia del catalogo Bike It 2013, che ha due lati. Questa è la sezione stradale (ROAD), girando il catalogo troverai la sezione dedicata al motocross (OFF ROAD). Speriamo che il formato del catalogo ti permetterà una consultazione rapida. I prezzi di acquisto non sono indicati sul catalogo, bensì sul CD-Rom in allegato. Il tuo Agente di Zona può fornirti anche una copia stampata mentre gli aggiornamenti con i nuovi articoli saranno disponibili in formato Excel durante l'anno. Vorremmo sottolineare lo sforzo che Bike It sta facendo per offrire dei prezzi di trasporto vantaggiosi; in molti paesi europei, al raggiungimento di un determinato fatturato per ordine, offriamo addirittura il porto franco. Consulta la tabella dei Costi di Trasporto (FREIGHT RATES).



Da ormai due anni il catalogo è disponibile anche on line nel formato Flipping Book. Sul nostro sito si possono trovare anche i nostri rivenditori nella sezione dealer locator . Se sei un nostro rivenditore che compra direttamente dall'Inghilterra, è disponibile anche un sito, dove potrai ordinare on-line. Così saprai subito la disponibilità dell'articolo desiderato, il valore totale dell'ordine, la storicità degli ordini fatti in questo modo. Vedi le pagine 2 e 3 del catalogo per ulteriori informazioni. Non utilizzi ancora questo sistema? Chiedi informazioni al tuo Agente Bike It. Ti auguriamo un buon lavoro e molto successo con questo Catalogo!

## Contenuto

<b>MotoGP</b>	16-28
<b>Scarichi</b>	29-47
<b>Cupolini</b>	48-54
<b>Scooter &amp; Moto Piccola cilindrata</b>	55-70
<b>Leve e manubri</b>	71-102
<b>Fanali anteriori</b>	103-111
<b>Frecce</b>	112-125
<b>Specchietti</b>	126-140
<b>Fanali posteriori</b>	141-151
<b>Alzamoto &amp; Cavalletti</b>	152-161
<b>Utensili</b>	162-189
<b>Batterie &amp; Caricabatterie</b>	190-195

<b>Elettronica</b>	196-198
<b>Catene</b>	199-213
<b>Filtri, Freni e Ricambi</b>	214-236
<b>Gomme &amp; Tubi</b>	237-243
<b>Antifurti e catene</b>	244-252
<b>Accessori moto</b>	253-273
<b>Portapacchi</b>	274-279
<b>Accessori pilota</b>	280-293
<b>Paraserbatoi</b>	294-296
<b>Extras</b>	297-315

# www.bikeit.co.uk



<b>A</b>	<b>PAGINA</b>				
Acido batteria	192	Colla per manopole	90	Lampadine per fari	111
Adattatore specchietti	140	Connettore HT	197	anteriori	
Adattatori per cupolino	54	Contagiri	263	Lavapezzi	167
Adesivi	28	Contenitore liquido freno	168	Leve OEM	92-102
Allargatore tubo	179	Contenitori graduati	169	Lubrificatore Catene	162
Allarme Garage	252	Copri - manopole	91	Lubrificatore cavi	179
Allarme Moto	252	Copri bottiglia termica	25	Lucchetto antifurto a U	247-251
Alzamoto a pantografo	159	MotoGP		Luci da parcheggio	111
Alzamoto Americana	159	Copri stivali pioggia	292	Luci porta targa	150-151
Alzamoto Custom	152	Copri valvole	241	Luci spot / fendinebbia	109
Alzamoto idrauliche	161	Coprimoto da pioggia	272-273	<b>M</b>	
Ammortizzatore di sterzo	255	Coprimoto polvere	272	Maniglie passeggero	292
Ammortizzatori	236	Copriquad	272	Manometri	173
Ancore a terra	245-247	Corno ad aria	303	Manometri - MotoGP	18
Ancore da veicolo ad anelli sgancio rapido	188	Cronometro	303	Manopole riscaldati	88
Anelli paravesciche	91	Cronometro digitale / transponder	315	Manopole scooter	89-90
Antipioggia	290	Cupolini	49-53	Manubri stradali	84-85
Attrezzi per valvole	170	Cursori a forcella - Gancio	156	Marmitte	32-43
<b>B</b>		Cuscinetti	230	Marmitte 2 Brothers	29
Bandana - MotoGP	23	<b>D</b>		Marmitte Custom	45
Bandiere	297	Db Killer Kit	31	universali	
Bandit Mask - MotoGP	22	Detersivo per visiera	290	Maschera - MotoGP	22
Barre magnetiche portautensili	175	Disco Freno	220-224	Maschera	291
Batterie	190-193	Distanziale per frecce carena	115	Misuratore carburatori	182
Batterie al Litio	190	<b>E</b>		Misuratore con pinza	179
Bauletto	276	Equilibratrice	171	Morse blocca ruota	157
Blocca dischi	247-251	Etilometro	303	Morsetto tubo benzina	168
Bobine di accensione	197	<b>F</b>		<b>N</b>	
Bordo per cupolino	54	Fari anteriori cromati	103-109	Nastri da cerchio	243
Borraccia MotoGP	25	Fari posteriori LED	141-149	Nastro adesivo americano	187
Borsa pilota	276	Fasce luminose LED	271	<b>O</b>	
Borsa porta ruota	253	Fascette	178	Occhiali da sole	305
Borsa porta tuta - MotoGP	21	Fascia blocca freno	189	Oliatore	169
Borsa serbatoio	277	Filo stringi manopole	179	Ombrelli - MotoGP	28
Borse laterali tessuto	275	Filtri benzina	225	Orologi	263
Boxer MotoGP	24	Filtri olio	227-230	<b>P</b>	
Bretelle	292	Filtro Aria - Kit manutenzione per	235	Pad per cavalletto	271
<b>C</b>		Filtro Aria Moto	232-234	Paraserbatoio	294-296
Calibro a corsoio	176	Stradale		Pastiglie freno	215-218
Calibro vuoto di pressione	182	Frecce	112-123	Pedane poggiapiedi	259-262
Calze - MotoGP	24	Fusibili	197	Pellicola visiera - MotoGP	23
Camel bag	278	<b>G</b>		Penna marca gomme	243
Camere d'aria	281	Ganci carena	264	Pesi equilibratura	242
Camere d'aria	242	Gancio per ragno	279	Piastrine per frecce	124
Camicette paddock	287	Giacca catarifrangente	289	Pinze aprifreni	179
Candele	235	Griglia carena	264	Pipetta per candele	197
Candele NGK	235	Guanti	282-283	Placca porta targa	150
Caraffa carburante	169	Guanti per meccanici	163	Pneumatici	237-239
Carene con fari anteriori	103-105	Guarnizioni marmitta	44	Poltrone paddock	298
Caricabatterie	194	Guida cavi	91	Pompa a piede	173
Carrello per cavalletto centrale	160	<b>H</b>		Ponte alzamoto	161
Carrello porta utensili	185	<b>I</b>		Porta - GPS	274
Caschi	280	Idropulitrice	167	Porta assicurazione	268-269
Catarifrangente adesivo	270	Imbuto per acido	195	Porta GPS	274
Catene	200-202	Imbuto per benzina	169	Portacellulare	274
Catene e lucchetti	245-249	Imbuto per olio	169	Portachiavi	304-305
Catene Kit	203-213	Interfoni	293	Portachiavi Lanyard	27
Cavalletti	153-155	Intermittenza per frecce	125	Presa accendisigari	315
Cavalletto spostato	152	Intermittenza per frecce a LED	125	Prodotti per cura tessuto / pelle	288
Cavetto blocca disco	251	Interruttore a pressione olio	197	Prodotti per pulizia	162
Cavo Booster	195	Interruttore frizione	198	Protettori forcella	271
Chiave	184	Interruttori	198	Protezione Manubrio - Paracolpi	84
chiave ammortizzatore		Interruttori di spegnimento	198	<b>R</b>	
Chiave asse ruota	171	<b>J</b>		Ragni elastiche	279
Chiave candela	165	<b>K</b>		Rampe	158
Chiave filtro olio	174	Kit lucidatore	163	Regolatore carburatore	182
Chiavi Allen	176	Kit pronto soccorso	293	Regolatore di velocità	87
Chiavi esagonali	177	Kit ripara gomme	172	Regolatori cavo	91
Cinghia Manubrio	189	Kit riparatore cavi	179	Regolatori di tensione	197
Cinghie ferma moto	188	Kit viti colorati	263	Regolatori precarico forcella	258
		<b>L</b>		Relè frecce LED	125
		Lampada da lavoro a LED	178	Resistenze per frecce a LED	125
				Rete antiscivolo	276
				Rete elastica	279
				Rivettatrice	178
				Rullo ruota	160
				Ruote per cavalletti	155
				<b>S</b>	
				Sacchetti porta casco	279
				Salvadanaio	303
				Saponette - MotoGP	23
				Scaffalino parta casco / tuta	299
				Scalda gamba / vite scooter	273
				Scalda ginocchio	292
				Neoprene	
				Scaldamani	293
				Scaldamani per manubrio	84
				Scaldareni	292
				Scalza pneumatici	170
				Segnali di parcheggio	297
				Semimanubri	84
				Separatore cavi	91
				Serbatoio carburante ausiliario	169
				Sgabelli da officina	175
				Sgancio rapido tubo benzina	225
				Sigilli forcella	231
				Siringhe	184
				Sottocaschi	291
				Sottocaschi - MotoGP	22
				Sottotute	286
				Specchietti	126-139
				Sposta moto	160
				Spurgatore freni	168
				Staffe fari anteriori	105,110
				Strisce adesive cerchi	242
				Supporti cavalletto	156
				Supporti cavalletto	156
				Supporti cavalletto	156
				<b>T</b>	
				Tachimetro	263
				Tamponi carena	256-257
				Taniche Jerry	169
				Tappeti	300-301
				Tappi orecchie	281
				Tappi serbatoio	266-267
				Tappi serbatoio	266-267
				Tappo olio	265
				Tappo valvola	243
				con indicatore di pressione	
				Tavolo	299
				Tazze - MotoGP	25
				Tende da sole	302
				Terminali Manubrio	86-87
				Termocoperte	253
				Tester batteria	195
				Torcia	303
				Trombe	196
				Tubi di raccordo per marmitta	32-43
				Tubo benzina	225
				Tubo per collo	291
				<b>U</b>	
				UTAG	306-307
				Utensili per catene	180
				Utensili per gomme	170
				<b>V</b>	
				Valvole	241
				Valvole per gomme	241
				Vaschetta cambio olio	169
				Visiere per fari anteriori	108
				Viti decorative	271
				Viti porta targa	265
				<b>Z</b>	
				Zaino	278
				Zaino	278
				Zerbini	299

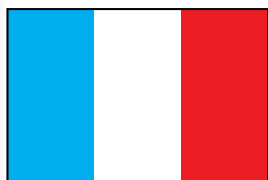

# Français

Chers clients Bike It,

Voici votre catalogue Bike It 2013 catalogue, qui est divisé en deux parties. Cette partie est le volet ROUTE, retournez le catalogue pour retrouver le volet MX.

Vos prix d'achat ne figurent dans ce catalogue, mais dans un tarif à part, disponible en format papier ou Excel (sur CD ou par email). Nos frais de transport sont très compétitifs et nous proposons des livraisons en franco de port basées sur la valeur de la facture vers la plupart des pays européens (voir le tableau de frais de port dans le tarif pour plus de détails).



Sur notre site web vous trouverez aussi ce même catalogue à feuilleter, ainsi qu'un moteur de recherche destiné aux particuliers pour localiser nos points de vente dont vous.

Vous avez également la possibilité de commander en ligne sur notre portail professionnel, avec une connexion sécurisée, et bénéficiez d'autres fonctions pratiques – la recherche rapide, la disponibilité en stock, la saisie de commande rapide et l'historique de vos commandes. De plus, nous vous envoyons un email lorsque vous passez une commande pour en accuser sa réception.

Les pages 2 et 3 de ce volet ROUTE du catalogue contiennent plus d'informations sur notre site web et notre portail.

Si vous n'utilisez pas notre portail encore, demandez à votre agent ou responsable commercial Bike It pour établir votre accès.

## Sommaire

<b>MotoGP</b>	16-28
<b>Echappements</b>	29-47
<b>Bulles &amp; Saute-vents</b>	48-54
<b>Commuter</b>	55-70
<b>Accessoires guidon</b>	71-102
<b>Phares</b>	103-111
<b>Clignotants</b>	112-125
<b>Rétroviseurs</b>	126-140
<b>Feux arrières</b>	141-151
<b>Béquilles &amp; Lève-motos</b>	152-161
<b>Outils</b>	162-189
<b>Batteries &amp; chargeurs</b>	190-195

<b>Composants électriques</b>	196-198
<b>Chaines</b>	199-213
<b>Consommables</b>	214-236
<b>Pneus &amp; chambres à air</b>	237-243
<b>Antivol</b>	244-252
<b>Accessoires moto</b>	253-273
<b>Bagages</b>	274-279
<b>Equipment pilote</b>	280-293
<b>Protège-réservoirs</b>	294-296
<b>Divers</b>	297-315

# www.bikeit.co.uk



<b>A</b>	<b>PAGE</b>	Colliers de serrage	178	Joint de bulle	54	Récipient liquide de frein	168
Acide de batterie	192	Compte tours	263	Joints de fourche	231	Régulateur de vitesse	87
Adaptateurs de rétroviseurs	140	Compteur de vitesse	263	Joints échappements	44	Régulateurs	197
Air Filter Care Kit	235	Connecteur câble HT	197	<b>K</b>		Rélais LED	125
Air Filters Road	232-234	Contacteur	198	Kit anti crevaison	172	Repose-pieds	259-262
Ajusteur de câble	91	embrayage		Kit câble	179	Réservoir d'essence	169
Alarmes de garage	252	Contacteur press.	197	Kit chaînes	203-213	auxiliaire	
Alarmes de moto	252	huile		Kits de pôlissage	163	Résistance pour	125
Alcotest	303	Contacteurs	198	Klaxons	196	clignotants LED	
Amortisseur de direction	255	Cordon de rappel	251	<b>L</b>		Rétroviseurs	126-139
Amortisseurs	236	Corne de brume	303	Lampe de poche	303	Rondelles de	91
Ampoules	111	Coupe circuits	198	Laveur haute pression	167	poignées	
Anneau de fixation	245-247	Couvertures chauffantes	253	LED autocollant	271	Rouleurs de	160
Anneaux d'arrimage	188	Crochets d'arrimage	279	Lève- moto custom	152	graissage	
Attaches-rapides	264	Crochets de béquilles	156	Lève moto hydr. custom	159	Roulements	230
<b>B</b>		<b>D</b>		Lève moto	161	Roulettes de béquille	155
Bac de vidange	169	Démonte pneus	170	hydraulique		<b>S</b>	
Baladeuse LED	178	Dépressiomètres	182	Léviers type origine	92-102	Sac de casque	279
Bandana – MotoGP	23	Dérive chaîne	178	Lubrifiant de chaîne	162	Sac pilote	276
Bandes de jantes	242	Désaccoupleur de durite	225	Lubrificateur de câble	179	Sacoche cavalières	275
Barnums	302	Diabolos	156	Lunettes de soleil	305	Sacoche de réservoir	277
Barres magnétiques	175	Diabolos	156	<b>M</b>		Sacoche GPS	274
Batteries	190-193	Diabolos	156	Manchons	84	Sacoche GPS	274
Batteries Lithium Ion	190	Disques de frein	220-224	Marqueur de pneu	243	Sacs à dos	278
Béquille ARR 3 roues	152	Doseurs gradués	169	Masque néoprène – MotoGP	22	Sacs à dos	278
Béquille cadre custom	159	Doseurs gradués	169	Masques	291	Sandows	279
Béquille fixe	153	Douille à frapper	184	Masques – MotoGP	22	Sangle bloque levier	189
Béquilles acier	153-155	Drapeaux	297	Molettes de fourche	258	Sangles	188
Bloc disques	247-251	Durite de carburant	225	Mousses de guidon	84	Sangles d'arrimage	189
Bloque roue avant	157	<b>E</b>		Multimètre	179	pour guidon	
Bobine d'allumage	197	Echappements	32-43	<b>N</b>		Scotch US	187
Bouchon de vidange	265	Echappements 2	29	Nettoyant d'écran	290	Séparateurs de câble	91
Bouchons de réservoir	266-267	Brothers		<b>O</b>		Servante d'atelier	185
Bouchons de réservoir	266-267	Eclaireurs de plaque	150-151	Obturbateur clignotant	124	Silencieux universels	45
Bouchons de valve	241	Elargisseur de tube	179	Outil carburetteur	182	Sliders genoux – MotoGP	23
Bouchons de valve avec jauge	243	Embouts de guidon	86-87	Outils pour chaînes	180	Sous vêtements	286
Bouchons d'oreilles	281	Entonnoir	169	Outils pour étrier de frein	179	Stickers	28
Bougies	235	Entonnoir	169	Outils pour pneus	170	Support de plaque	150
Bougies NGK	235	Entonnoir acide	195	Outils pour valves	170	Surbottes	292
Bracelets (guidon)	84	Equilibreuses	171	<b>P</b>		Syringues	184
Bretelles	292	Etagère de rangement	299	Paillassons	299	<b>T</b>	
Bulle - Accessoires	54	Etui bouteille – MotoGP	25	Parapluies – MotoGP	28	Table	299
Bulles	49-53	<b>F</b>		Pattes de phare	105,110	Table d'atelier	161
Burette huile	169	Feu parking	111	Phare anti-brouillard	109	Tablier de scooter	273
<b>C</b>		Feux arrières	141-149	Phares	103-109	Tabourets d'atelier	175
Câbles de batterie	195	Fil à freiner	179	Pied à coulisse	176	Tampons de protection	256-257
Cagoules	291	Filet fixe bagages	279	Pince durite	168	Tapis de garage	300-301
Cagoules – MotoGP	22	Filets de jantes	243	Plaque manoeuvre moto	160	Tasses – MotoGP	25
Cale à béquille	271	Films d'écran – MotoGP	23	Plaques parking	297	Testeur de batterie	195
Caleçons – MotoGP	24	Filtres à essence	225	Plaques phares	103-105	Tire-lire	303
Cales de clignotants	115	Filtres à huile	227-230	Plaquettes de frein	215-218	Top cases	276
Caméra	281	Fontaine de lavage	167	Plateau à roulettes	160	Tour de cou	291
Capuchons de bougie	197	Fusibles	197	Plombs d'équilibrage	242	Tour de cou pour clés	27
Casques	280	<b>G</b>		Pneus	237-239	Trousse médicale	293
Catadioptre	270	Gants	282-283	Poche d'hydratation	278	<b>U</b>	
Ceinture thermique	292	Gants de mécano	163	Poignées	89-90	U - antivols	247-251
Centrale clignotants	125	Gilet réfléchissant	289	Poignées chauffantes	88	UTAG	306-307
Centrale clignotants LED	125	Gourde – MotoGP	25	Poignées d'amour	292	<b>V</b>	
Chaîne + cadenas	245-249	Grille pour carénage	264	Pompe à pied	173	Valves	241
Chaînes	200-202	Guide câbles	91	Porte assurance	268-269	Valves	241
Chaises paddock	298	Guidons - route	84-85	Porte clés	304-305	Vêtements de pluie	290
Chambres à air	242	<b>H</b>		Prise de recharge	315	Vis - coffrets	263
Chargeurs de batterie	194	Horloges	263	Produits d'entretien cuir/textile	288	Vis de plaque	265
Chaufferettes	293	Housse de jante	253	Produits d'entretien-nettoyage	162	Vis décoratifs	271
Chaussettes – MotoGP	24	Housse téléphone	274	Prot. Genoux néoprène	292	Visières pour phares	108
Chemises paddock	287	Housses anti-poussières	272	Protection carénage	276	<b>W</b>	
Chicanes	31	Housses de moto	272-273	Protection fourche	271		
Chronomètre	303	Housses de vêtements – MotoGP	21	Protège poignées	91		
Chronomètre transpondeur	315	Housses quad	272	Protège réservoir	294-296		
Clé à bougie	165	<b>I</b>		Purgeurs de frein	168		
Clé axe de roue	171	Intercoms	293	<b>R</b>			
Clé filtre à huile	174	<b>J</b>		Raccords	32-43		
Clés Allen	176	Jauge carburetteur	182	d'échappement			
Clés Allen	177	Jauge de pression	173	Rampe de chargement	158		
Clignotants	112-123	Jauge de pression de pneus – MotoGP	18				
Colle pour poignées	90	Jerrycans	169				

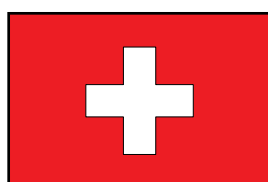

# Deutsch

Sehr geehrter Bike It Kunde,

Anbei erhalten Sie in Ihren persönlichen Bike It Katalog 2013, der zwei Fronten hat. Auf dieser Seite finden Sie die ROAD Strassen-Sektion. Wenn Sie den Katalog umdrehen, finden Sie alle MotoCross bezogene Produkte in der OFF ROAD Sektion zusammengefasst. Wir möchten Ihnen einige Hinweise abgeben, um die Zusammenarbeit einfacher zu gestalten. Ihre Einkaufspreise sind nicht im Katalog gedruckt, sondern in einer separaten Preisliste, auf einer CD oder als Email in einer Excel-Datei zu finden. Wir möchten Sie darauf hinweisen, dass Bike It ein sehr attraktives Frachtgebührensysteem unterhält, so das Frei-Haus Lieferungen in viele EU-Länder möglich sind, abhängig von minimalen länderspezifischen Rechnungswerten. Schauen Sie sich dazu unsere "Freight Rates" Tabelle an.



Bike It bietet auf der neu gestalteten Website [www.bikeit.co.uk](http://www.bikeit.co.uk), diesen Katalog als sogenanntes "Flipping Book", auch Online an. Ebenso bieten wir Endverbrauchern mittels dem Retail Outlets Dealer Locator Service, Sie als Bike It Kunde zu finden bzw. anzurufen. Unter Online Ordering, unserem kennwortgeschütztem Händler-Shop System, bieten wir Ihnen schnelles Suchen, Lagerinformationen, schnelle Auftragseingabe sowie Auftragsbestätigung per Email und Ihre Auftragsvergangenheit an. Schauen Sie auch noch auf den Seiten 2 und 3 für weitere Website-Informationen. Verwenden Sie unser Onlinebestellen noch nicht? Dann sprechen Sie bitte mit Ihrem lokalen Bike It Agenten oder kontaktieren Sie die Verkaufsleitung im European Office. Wir wünschen Ihnen viel Spaß beim Blättern in unserem neuen Katalog und freuen uns auf Ihren Einkauf!

## Inhaltsverzeichnis

<b>MotoGP</b>	16-28
<b>Auspuffsysteme</b>	29-47
<b>Verkleidungsscheiben</b>	48-54
<b>Roller &amp; Leichte Motorräder</b>	55-70
<b>Lenkung &amp; Hebel</b>	71-102
<b>Scheinwerfer</b>	103-111
<b>Blinker</b>	112-125
<b>Spiegel</b>	126-140
<b>Rückleuchten</b>	141-151
<b>Heber &amp; Ständer</b>	152-161
<b>Werkzeug</b>	162-189

<b>Batterien &amp; Ladegeräte</b>	190-195
<b>Elektrik</b>	196-198
<b>Ketten</b>	199-213
<b>Wartung &amp; Service</b>	214-236
<b>Reifen &amp; Schläuche</b>	237-243
<b>Schlösser</b>	244-252
<b>Motorradzubehör</b>	253-273
<b>Gepäck</b>	274-279
<b>Fahrerzubehör</b>	280-293
<b>Tankpads</b>	294-296
<b>Verschiedenes</b>	297-315

# [www.bikeit.co.uk](http://www.bikeit.co.uk)



# Inhaltsverzeichnis

2 Brothers	29	Handschuhe	282-283	<b>O</b>	Ohrstöpsel	281	<b>T</b>	Tachos	263
Auspuffanlagen		Handschuhe für	163	Ölablass-Schrauben	265	Tankdeckel	266-267	Tankdeckel	266-267
<b>A</b>	<b>SEITE</b>	Mechaniker		Ölauffangbehälter	169	Tank-Pads	294-296	Tanktaschen	277
Achs-Spanner	171	Handwärmer	293	Öldruckgeber	197	Taschenlampe	303	Tassen – MotoGP	25
Adapterrollen	156	Hauptständer beweglich	160	Ölfilter	227-230	Teilewascher	167	Telefonhüllen	274
Adapterrollenhaken	156	Hebebühnen	161	Ölfilterzangen	174	Tisch	299	Topcases	276
Alkoholtester	303	Hebel original Ersatz	92-102	Ölkanne	169	Trinkflasche – MotoGP	25	Trinkrucksack	278
ATV-Hüllen	272	Hebelblockierspanngurt	189	Öltrichter	169	Trinkmatten	299	<b>U</b>	Überstiefel
Aufkleber	28	Helm Spardose	303	<b>P</b>	Paddockshirts	287	Uhren	263	Unterwäsche
Auspuff Universal	45	Helmhüllen	279	Parkleuchten	111	U-Schlösser	247-251	UTAG	306-307
Auspuffanlagen	32-43	Hochdruckreiniger	167	Parkschilder	297	<b>V</b>	Ventile	241	Ventilkappen
Auspuffdichtungen	44	Hosenträger	292	Polierkits	163	Ventilwerkzeug	170	Verbindungsrohre	32-43
Auspuffrohr Aufweiter	179	Hupen	196	<b>R</b>	Regenabdeckplanen	272-273	Vergasersynchrontester	182	Vergasersynchrontester
Ausrüstungstaschen	276	Hydraulische Heber	161	Räder-Roller	160	Regenbekleidung	290	Vergasereinstellwerkzeug	182
Ausrüstungswartung	288	<b>I</b>		Regenschirme – MotoGP	28	Reifen	237-239	Verkleidung-Schnellverschlüsse	264
Auswuchtgewichte	242	Imbus Schlüssel	176	Reifen Auswuchtständer	171	Reifenluftdruckmessgeräte	173	Verkleidungsscheinwerfer	103-105
<b>B</b>		Inbusschlüssel	177	Reifenmontagewerkzeug	170	Reifenmontierhebel	170	Versicherungsscheiben	268-269
Bandana – MotoGP	23	Injektoren	184	Reifenstifte	243	Reifenntasche	253	Visierfolien – MotoGP	23
Banditmaske – MotoGP	22	Isolationsband	187	Reifenwärmer	253	Reifenstifte	253	Visier-Reiniger	290
Batterie Ladegeräte	194	<b>J</b>		Reinigungsmittel	162	Reifenwärmern	253	Vorderreifenständer	157
Batterien	190-193	Kabelbinder	178	Rollerschürzen	273	Reinigungsmittel	162	<b>W</b>	Werkzeugmagnethalterung
Batteriesäure	192	Kabelhalter	91	Rücklichter LED	141-149	Reifenluftdruckmessgeräte	173	Werkzeugschrank	185
Batterietester	195	Kabelöler	179	Rucksäcke	278	Reifenmontagewerkzeug	170	<b>Z</b>	Zelte
Beheizbare Griffe	88	Kabelrenner	91	Rucksäcke	278	Reifenmontierhebel	170	Zelte	302
Benzinfilter	225	Kamera	281	Rucksäcke	278	Reifenstifte	243	Zündkerzen	235
Benzinkanister	169	Kennzeichenträger	150	Rucksäcke	278	Reifenstifte	243	Zündkerzeneinsätze	165
Benzinkanne	169	Kennzeichenträger LED	150-151	Rundenzähler	315	Reifenstifte	243	Zündkerzenkabelverlängerung	197
Benzinmessbecher	169	Beleuchtung		Säuretrichter	195	Reifenstifte	243	Zündkerzenstecker	197
Benzinschlauch	225	Kennzeichenträgerbolzen	265	Schalter	198	Reifenstifte	243	Zündspulen	197
Schnellverschluss		Ketten	200-202	Scheiben	49-53	Reifenstifte	243	Zusatzscheinwerfer	109
Benzinschlauchzange	168	Kettenkits	203-213	Scheibenbremsbeläge	215-218	Reifenstifte	243		
Benzintrichter	169	Kettenöl	162	Carbon-Pro		Reifenstifte	243		
Blinker	112-123	Kettenwerkzeug	180	Scheibenleiste	54	Reifenstifte	243		
Blinkermontageplatten	124	Kill Schalter	198	Scheibenschlösser	247-251	Reifenstifte	243		
Blinkerverlängerung	115	Kleidersack – MotoGP	21	Scheibenschloss-Memorykabel	251	Reifenstifte	243		
Blinkerwiderstand LED	125	Knieschleifer – MotoGP	23	Scheibenzubehör	54	Reifenstifte	243		
Blinkgeber	125	Kniewärmer	292	Scheinwerfer Chrom	103-109	Reifenstifte	243		
Blinkgeber LED	125	Kommunikation	293	Scheinwerferblenden	108	Reifenstifte	243		
Blinkgeber LED	125	Kratzschutz	276	Scheinwerferhalter	105,110	Reifenstifte	243		
Bodenanker	245-247	Kugellager	230	Schlauch Flickzeug	172	Reifenstifte	243		
Bowdenzug Einsteller	91	Kupplungsschalter	198	Schläuche	242	Reifenstifte	243		
Bowdenzug Reparaturkit	179	<b>L</b>		Schlauchlosventile	241	Reifenstifte	243		
Boxer Shorts – MotoGP	24	Laderampe	158	Schlösser	245-249	Reifenstifte	243		
Bremsbackenwerkzeug	179	LED Arbeitslampe	178	Schlüsselanhänger	304-305	Reifenstifte	243		
Bremsflüssigkeitsbehälter	168	LED Leuchtstreifen	271	Schlüsselbänder	27	Reifenstifte	243		
Bremsscheiben	220-224	LED Leuchtstreifen	271	Schraubensätze	263	Reifenstifte	243		
Bürostühle	298	Lendenwärmer	292	Schwingen-Adapterrollen	156	Reifenstifte	243		
<b>C</b>		Lenker Strasse	84-85	Schwingen-Adapterrollen	156	Reifenstifte	243		
<b>D</b>		Lenkergerichte	86-87	Seitenständerpads	271	Reifenstifte	243		
DB Killer	31	Lenkerschutz	84	Seitentaschen	275	Reifenstifte	243		
Dekorative Bolzen	271	Lenkerstulpen	84	Sicherungen	197	Reifenstifte	243		
Drehzahlmesser	263	Lenkungsdämpfer	255	Sicherungsdraht	179	Reifenstifte	243		
<b>E</b>		Lithium Ionen Batterien	190	Socken – MotoGP	24	Reifenstifte	243		
Entlüfterkit	168	Luftdruckprüfer – MotoGP	18	Sonnenbrillen	305	Reifenstifte	243		
Erste Hilfe Kit	293	Luftdruckventilkappen	243	Soziusgriffe	292	Reifenstifte	243		
Extrerner Benzintank	169	Luftfilter Strasse	232-234	Spanngummis	279	Reifenstifte	243		
<b>F</b>		Luftfilter-Pflegeset	235	Spanngurtanker	188	Reifenstifte	243		
Fahnen	297	Luftfilter	303	Spanngurte	188	Reifenstifte	243		
Felgenband	242	Lufthorn		Spanngurt-Lenkerhalterung	189	Reifenstifte	243		
Felgenbänder	243	<b>M</b>		Spiegel	126-139	Reifenstifte	243		
Flaschenkühler – MotoGP	25	Mechanikerhocker	175	Spiegeladapter	140	Reifenstifte	243		
Fusspumpen	173	Mesh Gitter Metall	264	Starterkabel	195	Reifenstifte	243		
Fussrasten	259-262	Messschieber	176	Staubhüllen	272	Reifenstifte	243		
<b>G</b>		Mini-Heber	159	Steckdosen	315	Reifenstifte	243		
Gabelprotektoren	271	Motorrad	160	Stoppuhr	303	Reifenstifte	243		
Gabelregler	258	Garagenständer		Stossdämpfer	236	Reifenstifte	243		
Gabelsimmeringen	231	Motorrad-Alarmanlagen	252	Stossdämpferschlüssel	184	Reifenstifte	243		
Garagen-Alarmanlagen	252	Motorradheber	159	Stummellenker	84	Reifenstifte	243		
Garagenteppiche	300-301	Hydraulisch		Sturmhauben	291	Reifenstifte	243		
Gepäckhaken	279	Motorradständer	152	Sturmhauben – MotoGP	22	Reifenstifte	243		
Gepäcknetze	279	Motorradständer	152	Sturzprotektoren	256-257	Reifenstifte	243		
Geschwindigkeitsregler	87	Motorradständer mit Rollen	152	Systemhelme	280	Reifenstifte	243		
Gesichtsmasken	291	Motorradständer statisch	153			Reifenstifte	243		
Gleichrichter	197	Motorradständer-Räder	155			Reifenstifte	243		
Glühlampen	111	Multimeter	179			Reifenstifte	243		
Scheinwerfer		<b>N</b>				Reifenstifte	243		
GPS Tanktasche	274	Nackenrollen	291			Reifenstifte	243		
Griff Kleber	90	Navitaschen	274			Reifenstifte	243		
Griffdaumenschutz	91	Neopren Maske – MotoGP	22			Reifenstifte	243		
Griffe Roller	89-90	NGK Zündkerzen	235			Reifenstifte	243		
Griff-Stulpen	91	Nietset	178			Reifenstifte	243		
<b>H</b>						Reifenstifte	243		





**Item Page No.**

**A**

Acid Funnel	195
Air Filter Care Kit	235
Air Filters - Performance	234
Air Filters - Replacement	232-233
Air Filters - Scooter	219
Air Filters Scooter	55
Air Horn	303
Air Shock Pumps	184
Alarm Disc Lock	250
Alarms Bike	252
Alarms Garage	252
Alcohol Breath Tester	303
Allen Keys	176
Americana Stands	159
Antifreeze tester	168
Assortment Packs	187
ATV Covers	272
Awnings	302
Axle Bolt	171
Axle Spanners	171
Axle Tool	171

**B**

Back Packs	278
Baffle Kit	31
Balaclavas	291
Balaclavas - MotoGP	22
Bandana - MotoGP	23
Bandit Masks - MotoGP	22
Banjo Clamps	31
Bar Accessory Mounts	83
Bar Ends - LED	86
Bar Ends - Replacement	87
Bar Ends - Universal	86
Bar Ends Titax	255
Bar Muffs	70
Bar Muffs	84
Bar Pads	84
Bar Risers	83
Bar Straps	189
Base Layers	286-287
Batteries Dry Charge	193
Batteries DTX YTX	191
Batteries GEL	192
Batteries Lithium Ion	190
Batteries MGS	192
Batteries Scooter	60
Battery Chargers	194
Battery Testers	195
Bead Breaker	171
Bead Tools	170
Beanie Hats - MotoGP	22
Bearing Packer	184
Bearings	230
Bike Raiser Stand	152
Bike Stand Pads	271
Bleed Nipple Covers	230
Bobbin Hooks	156

**Item Page No.**

Bobbin Hooks - MotoGP	16
Bobbin Spools Titax	255
Bobbins	156
Bolt Packs	187
Booster Cables	195
Bottle Cooler - MotoGP	25
Boxer Shorts - MotoGP	24
Braces	292
Braces - MotoGP	24
Brake Bleeders	168
Brake Caliper Tool	183
Brake Discs - Front	220-222
Brake Discs - Rear	223-224
Brake Reservoir - MotoGP	18
Bulbs - Headlight	111
Bulbs - Indicator	125
Bulbs - Rear Light	149
Bulbs - Rear Light LED	149
Bum Bag	278
Bumper Studs	294

**C**

Cable Adjusters	91
Cable Guides	91
Cable Locks	251
Cable Lubricators	179
Cable Repair Kit	179
Cable Separators	91
Cable Ties	178
Caliper Tools	179
Camera	281
Can Cooler - MotoGP	25
Can Shield	31
Can Straps	31
CAPPA Valve Caps	243
Carb Tool	182
Carbon Tax Discs	268
Carburettor Gauge	182
Cargo Nets	279
Centre Stand Movers	160
Centre Stand Stopper	31
Chain & Sprocket Kits	203-213
Chain & Sprocket Kits	56-57
Chain Alignment Tool	180
Chain Brushes	180
Chain- Cam	202
Chain Cleaner	181
Chain HD	200
Chain Lube	162
Chain O-Ring Black	201
Chain O-Ring Gold	202
Chain Pliers	181
Chain Solid Bush	201
Chain Standard	200
Chain Tools	180
Chain X-Ring	202
Clamp Meter	179
Cleaners	162
Cleaning Brushes	166

**Item Page No.**

Cleaning Cloths	166
Clip-On Bars	84
Clocks	263
Clutch Rollers	47
Clutch Switches	198
CO2 Kit	173
Combination Wrenches	183
Cotter Pins	187
Crash Protectors	256-257
Creeper Seats	175
Cruise Aids	87
Custom Bolts	271

**D**

dB Killers	31
Disc Lock	247, 249-251
Disc Lock Reminder	251
Disc Pads	215-218
Doormats	299
Doormats - MotoGP	28
Drinks Bottle - MotoGP	25
Dust Covers	272
Dust Covers - MotoGP	16

**E**

Ear Foams	281
Easy Loops	189
Easy Masks	291
Electrolyte	193
Exhaust Gaskets	44
Exhaust Mounts	44
Exhaust Packing	31
Exhaust Reducers	44
Exhaust Wrap	264
Eyewear	305

**F**

Face Masks	291
Fairing Fasteners	264
Fairing Mesh	264
Fingerbands	281
First Aid Kit	293
Flags	297
Flange bolts	263
Fluid Receiver	168
Flywheel Holder	183
Flywheel Puller	183
Foot Pumps	173
Footpegs	259-262
Footpegs Adjustable	261
Footpegs OEM	261
Fork Adjusters	258
Fork Adjusters Titax	254
Fork Oil Adjuster	184
Fork Oil Seal Driver	184
Fork Protectors	271
Fork Seals	231
Fork Stroke Indicators	231
Frame Sliders	256-257
Front Head Stand	155

Item	Page No.
Fuel Cans	169
Fuel Cap Decal	294
Fuel Caps	266-267
Fuel Filters	225
Fuel Funnel	169
Fuel Hose	225
Fuel Jug	169
Fuel Line Clamp	168
Fuel Line Coupler	225
Fuel Measuring Jugs	169
Fuel Syphon	169
Fuel Tank	169
Fuel Taps	225
Fuse Holders	197
Fuses	197

**G**

Garage Mats	300-301
Garage Mats - MotoGP	21
Garment Bags - MotoGP	21
Gazebos	302
Gel Tax Discs	268
Gloves - Inner	284
Gloves - Latex	163
Gloves - Mechanic	163
Gloves - Summer	282-283
Gloves - Winter	282-283
GPS Bags	274
Grip Donuts	91
Grip Glue	90
Grip Sleeves	91
Grip Sleeves - MotoGP	18
Gripper Tank Pads	294
Grips - Custom	89-90
Grips - Foam	89
Grips - Heated	88
Grips - MotoGP	18
Grips - Rubber	89
Grips Scooter	59
Ground Anchors	245, 247

**H**

Hand Warmers	293
Handlebars Road	84-85
Hazard Lamp	279
Head Tube - MotoGP	23
Headlight Brackets	105, 110
Headlight Clip	111
Headlight Visors	108
Headlights - Dominator	107
Headlights - Dominator 2.0	106
Headlights - Fairing	103-105
Headlights - Projector	106
Headlights - Replacement	109
Headlights - Round	108
Heat Shield	264
Helmet Bag	279
Helmet Bags - MotoGP	21
Helmet Fun	303

Item	Page No.
Helmet Liner	291
Helmet Lock	252
Helmet Skirt	281
Helmet Store	278
Helmets Flip	280
Helmets Full Face	280
Hex Keys	177
Horns	196
Hour Meters	263
HT Lead	197
Hydration Bag	278
Hydraulic Lifts	161

**I**

Ignition Coils	197
Impact Driver	178
Indicator Leads	124
Indicator LED Relay	196
Indicator LED Resistor	125
Indicator LED Resistor	196
Indicator Relays	125
Indicator Relays	196
Indicator Relays - LED	111
Indicator Risers	115
Indicator Spacers	124
Indicators - Bulb	118-120
Indicators - Custom	121-123
Indicators - Fairing LED	115
Indicators - LED	112-117
Inner Tubes	63
Inner Tubes	242
Inner Wear	286
Inspection Mirrors	178
Insulation Tape	187
Intercomms	293

**J**

Jackets - Road	285
Jerry Cans	169

**K**

Key Store	185
Keyfobs	304-305
Keyfobs - MotoGP	26-27
Kit Bags	276
Kit Care	288
Kit Cart	185
Kit Shelf	299
Knee Sliders - MotoGP	23
Knee Warmers	292
Kneeling Pads	175

**L**

Lanyards - MotoGP	27
Lap Timer	315
LED Glo-Strips	271
LED Markers	271
LED Worklamp	178
Lever Jammer	189
Lever Sleeves	92
Levers - Adjustable	82-83

Item	Page No.
Levers - Biketek	82-83
Levers - Replacement	92-102
Levers - Titax	72-81
Levers British	102
Levers Scooter	58
Lift Jack	159
Lithium Ion Batteries	190
Loading Ramp	158
Lock & Chain	245, 248, 249
Lock Wire	179
Lock Wire Washers	179
L-Plates	69
L-Plates	270
Luggage Elastics	279
Luggage Hooks	279

**M**

Magnetic Tools	175
Map Pouch	277
Mirror Adaptors	140
Mirror Blocks	255
Mirrors - OEM Replacement	129-139
Mirrors - scooter	66
Mirrors - Universal	126-128
Money Box	303
Motorcycle Mover	160
Mouth Guard - MotoGP	22
Mud Flaps	270
Mugs - MotoGP	25

**N**

Neck Chains	307
Neck Tubes	291
Neck Tubes - MotoGP	22
Neo Masks - MotoGP	22
NGK Spark Plugs	235
Number Plate Bolts	265
Number Plate Hangers	150
Number Plate Lights	150-151

**O**

Oil Cans	169
Oil Drain bolts	265
Oil Filter Tools	174
Oil Filters	227-230
Oil Funnel	169
Oil Pressure Switch	197
Overboots	292

**P**

Paddock Chairs	298
Paddock Shirts	287
Paddock Stand Floating	152
Paddock Stand Wheels	155
Paddock Stands	153-155
Paddock Stands - MotoGP	16-17
Panniers	275
Pants - Road	285
Parking Light	111
Parking Signs	297
Parking Signs - MotoGP	28



Item	Page No.
Parts Washers	167
Petrol Caps	266-267
Phone Pouch	274
Pillion Buddy	292
Pillion Grippers	292
Pliers	176
Plug Caps	197
Pocket Tools	177
Polishing Ball	163
Polishing Kits	163
Power Socket	315
Power Washers	167
Pressure Gauges	173
Pressure Valve Caps	243
Pro Clean	164-165
Pulley Wrench	183
Puncture Repair Kits	172
<b>R</b>	
Race Numbers	270
Rain Covers	272-273
Rain Covers - MotoGP	16
Rainwear	290
Ratchet Spanners	177
R-Clips	187
Rear Light Spoilers	150
Rear Lights - Bulb Universal	148-149
Rear Lights - LED	141-144
Rear Lights - LED Universal	145-147
Rectifiers	197
Reflective Gilet	68
Reflective Gilet	289
Reflective Vests	68
Reflective Vests	289
Reflectors	70
Reflectors	270
Regulators	197
Rema Tip Top	172
Rider Chair	298
Rider Chairs - MotoGP	28
Rim Protectors	170
Rim Tapes	242
Rivetter	178
Roadside Kit	279
Ruck Sacks	278
Rucksack Cover	278
<b>S</b>	
Sam Browne Belt	289
Sat Nav Bags	274
Scooter Aprons	69
Scooter Aprons	273
Scooter Silencers	46-47
Scrapers	182
Screen bolts	54
Screen Trim	54
Screens	49-53
Screw Sets	263
Sena SMH10	310-311

Item	Page No.
Sena SMH10R	313
Sena SMH5	308
Sena SMH5 FM	309
Sena SPH10	312
Sena SR10	309
Shock Absorbers	236
Shock Wrenches	184
Side Paddock Stand	155
Silencer Gaskets	47
Silencers - scooter	64-65
Silencers Universal	45
Smart Phone Pouch	274
Socks - MotoGP	24
Solenoids	197
Spark Plug Gauges	165
Spark Plug Holder	165
Spark Plug Sockets	165
Spark Plugs	235
Speedos	263
Spill Kits	162
Spine Tank Pads	294-296
Spoke Wrenches	170
Spools	156
Spring Tool	179
Sprocket Bolts	263
Static Stand	153
Steering Dampers	255
Steering Head Bearings	231
Steering Head Cup Remover	184
Stethoscope	183
Stickers - MotoGP	28
Stop Switches	198
Stop Switches	198
Stopwatch	303
Sunglasses	305
Swing Arm Spools	156
Syringes	184
<b>T</b>	
Table	299
Table Lift	161
Tachos	263
Tail Packs	275
Tailpipe Expander	179
Tank Bags	277
Tank Pad Sheets	296
Tank Pads - MotoGP	20
Tank Protection	296
Tax Discs	268-269
T-Bars	177
Thatcham Locks	246
Tiedown Anchors	188
Tiedown Shrouds	188
Tiedown Straps	188
Tirox Brush	180
Titax Levers	72-81
Tool Boxes	185
Tool Chest	185

Item	Page No.
Tool Holders	175
Tool Roll	276
Top Boxes	69
Top Boxes	276
Torch	303
Torx Keys	177
Track Pumps - MotoGP	18
Trousers - Road	285
Two Bros Exhausts	29
Tyre & Tube Repair	172
Tyre Bag	253
Tyre Changer	171
Tyre Gauges	173
Tyre Levers	170
Tyre Paste	170
Tyre Pens	243
Tyre Pressure Gauges - MotoGP	18
Tyre Valves	241
Tyre Warmers	253
Tyre Warmers - MotoGP	18
Tyres ATV	240
Tyres Scooter	237
Tyres Scooter	61-62
Tyres Trail	241
Tyres Tube Type	238
Tyres Tubeless	239
<b>U</b>	
U-Locks	247, 250-251
Umbrellas - MotoGP	28
UTAG	306-307
<b>V</b>	
Vacuum Gauges	182
Valve Caps	241
Valve Extenders	241
Valve Puller	170
Valve Tools	170
Valves	241
Vehicle Decals	299
Verniers	176
Viper Exhausts	32-43
Visor Cleaner	290
Visor Pouch	281
Visor Tints - MotoGP	23
Voltage Tester	195
<b>W</b>	
Waist Warmer	292
Webbing Protector	276
Wheel Balancers	171
Wheel Chocks	157
Wheel Spinner	160
Wheel Stripes	243
Wheel Weights	242
<b>Y</b>	
Y Wrenches	177
Y-Bars	177

## Rain Covers

Waterproof protective raincover, 210D nylon shell. Full protective lining with heat resistant section. Adjustable under-bike webbing strap with Klik-fast buckle and mirror section venting. Complete with storage bag and printed design.

Order Code	Size
<b>MGPRCV01</b>	Medium
<b>MGPRCV02</b>	Large
<b>MGPRCV03</b>	Extra Large

Available in 3 sizes:  
 Medium fits up to 600cc  
 Large fits 750 - 1000cc  
 Extra Large fits 1200cc plus



## Indoor Dust Covers

Protective dry-use storage cover, lightweight 75g non-woven shell. Full protective heat resistant lining, adjustable under-bike webbing strap with klik-fast buckle. Storage bag and printed design.

Order Code	Size
<b>MGPDSV01</b>	Medium
<b>MGPDSV02</b>	Large
<b>MGPDSV03</b>	Extra Large

## Track & Paddock Stands

MotoGP track and paddock stands are essential for race and track days. The stands elevate the bike for ground clearance to remove wheels and improve access for repairs, bike set-up and to fit and remove tyre warmers.

MotoGP stands are constructed from 32mm tube, fully reinforced for extra strength, finished in durable black powder coating with PU ground-stops on the underside of the handle for easier handle access and improved contact grip.

Rear stands are supplied complete with spring loaded swingarm adaptors.

Front stands are supplied with under fork adaptors.

**FRONT**  
 Order Code: **MGPSTD02**

**REAR**  
 Order Code: **MGPSTD01**

**FRONT & REAR SET**  
 Order Code: **MGPSTD03**

NB - Front paddock stands should always be used in conjunction with a rear stand.



## Bobbin Hook Adaptors

Pair of bobbin hook adaptors replace standard cup adaptors, allowing you to lift the bike by the bobbins instead of swing arms.

Order Code: **PDSHOOK**



## Premium 1pc Paddock Stands

MotoGP Premium stands are manufactured from continuous uncut tubing, supplied as a ready-to-use stand requiring no self-assembly of tube sections. This superior design and production minimises potential weakening and movement of the stand, compared to conventional multi-part self-assembly paddock stands.

Stands are constructed from 32mm cold rolled steel, 1.4mm thick tubing (1.9mm on headlift upper section), and incorporate internal reinforcement steel plugs for increased stand strength and stability. All tube work is formed on leading CNC tube-bending machines ensuring optimum accuracy.

All stands are complimented by a durable black powder-coating, and feature injection moulded polyurethane wheels – robust, oil resistant and offering efficient grip and movement.

### Front

Front stands include a self-levelling zinc-coated under-fork hardware kit. RIDE Magazine 'BEST BUY'

#### FRONT

Order Code: **MGPSTD05**



NB - Front paddock stands should always be used in conjunction with a rear stand.

### Rear

Rear stands include a lockable zinc-coated bobbin-spool hardware kit for quick and effective lifting. The stand can be widened and is suitable for all the latest sportsbikes.

#### REAR

Order Code: **MGPSTD04**



MGPSTD05



MGPSTD04



MGPSTD06

### Headstand

Headstands include a selection of five headlift pins\* suitable for the majority of today's sportsbikes.

\* 13mm / 15mm / 16.5mm / 17mm / 18mm  
RIDE Magazine 'RECOMMENDED'

#### HEADSTAND

Order Code: **MGPSTD06**



- MotoGP
- Exhausts
- Screens
- Commuter
- Controls
- Headlights
- Indicators
- Mirrors
- Rear Lights
- Lifts & Stands
- Tools
- Batteries & Chargers
- Electrics
- Chain
- Servicing
- Tyres & Tubes
- Security
- Bike Accs
- Luggage
- Rider Accs
- Tank Pads
- Extras



## Tyre Warmers

Official MotoGP tyre warmer set, includes front and rear warmers.

Self fitting elasticated sides offer a snug fit and uniform heat distribution. Warmers heat to a thermostatically controlled 80 degree Celsius for optimum tyre temperature, and retain that setting until warmers are removed or switched off.

LED indicators clearly show when the warmers are heating or the thermostat is at the maximum temperature setting.

Supplied with storage bag.

The track day essential.

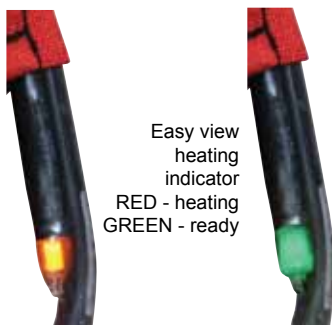

Easy view heating indicator  
 RED - heating  
 GREEN - ready

Two sizes available to fit all superbikes.



Order Code	Rear Fitment	Front Fitment	Plug
MGPWARM01	180/55-17 190/50-17 190/55-17	120/70-17	UK 3 pin
MGPWARM01E	180/55-17 190/50-17 190/55-17	120/70-17	Euro 2 pin
MGPWARM03	200/55-17	120/70-17	UK 3 pin
MGPWARM03E	200/55-17	120/70-17	Euro 2 pin

## Digital Tyre Warmers

Digitally controlled tyre warmer kit for optimum tyre preparation.

Both the front and rear warmers feature encased digital thermostat units which allow the user to manually input a desired temperature for the warmer to maintain.

The resulting advantage over standard tyre warmers is being able to heat the warmer to a higher or lower temperature according to weather conditions and time restraints, plus more accurate and easy to read data.

Features:

- LCD display for easy reading
- Power indicator light
- Temperature setting from 40-99 degree Celsius
- Real time temperature reading during heating



Order Code	Rear Fitment	Front Fitment	Plug
MGPWARM02	180/55-17 190/50-17 190/55-17	120/70-17	UK 3 pin
MGPWARM02E	180/55-17 190/50-17 190/55-17	120/70-17	Euro 2 pin

## Competition Grips

Premium material handlebar grip.  
 Grip efficient moulding.  
 Open ended for sports bike fitment.  
 Feature MotoGP logo.  
 Available in range of OEM colours.  
 Left 22mm / Right 25mm fitment.



Order Code	Colour
MGPGRP01	Black / Grey
MGPGRP03	Black / Blue
MGPGRP05	Black / Green
MGPGRP07	Black / Red
MGPGRP09	Black / Yellow



## 2-Stage Track Pump

- High volume / high pressure selectable.
- Fits Schrader (motorcycle / auto) and Presta (cycle) valves.
- Unique 2-stage mechanism enables optimum tyre inflation and accuracy up to 160psi

Order Code: **MGPTYR12**



## Track Pump

- Robust, lightweight track pump
- Contoured handle grip with inset pressure display
- Fold-up foot plates
- Essential for quick and accurate maintenance of tyre pressures

Order Code: **MGPTYR01**



## Brake Reservoir Shroud

MotoGP protective shroud, covers front brake master cylinder reservoir for protection and absorbs discharged brake fluid.

Order Code: **MGPBRK09**



## Tyre Pressure Monitor

Correct tyre pressures are essential for safe and successful motorcycle riding. Maintaining correct tyre pressure also ensures optimum fuel usage and tyre life.

The MotoGP Tyre Pressure Monitor allows any user to easily maintain tyre pressure.

- Digital LCD Display
- Selectable Pressure Ratings (PSI, BAR, KPA, KGF/CM2)
- Rotating Nozzle
- Pressure Release Button
- Anti-shock Case Protector
- CE Approved

Order Code: **MGTPM01**



## Grip Sleeves

Vinyl grip sleeves protect grips from oil and grease when work is being carried out. Great for use in transit to and from track days.

Order Code: **MGPSLV01**



MotoGP  
Exhausts  
Screens  
Commuter  
Controls  
Headlights  
Indicators  
Mirrors  
Rear Lights  
Lifts & Stands  
Tools  
Batteries & Chargers  
Electrics  
Chain  
Servicing  
Tyres & Tubes  
Security  
Bike Accs  
Luggage  
Rider Accs  
Tank Pads  
Extras



### 3pc Tank Protectors

**NEW**

Sports styling tank protectors.  
 Unique 3pc design ensures perfect fitment to fuel tanks.  
 High quality gloss coating.

Order Code	Design
<b>MGPTNK20</b>	Carbon Effect
<b>MGPTNK22</b>	Sic Red/White



### Tank Pad Protector Sheet

45x33cm adhesive protector sheet.  
 Protects bike tanks, bodywork and framework from abrasion.  
 Cut to required shape and size.

Order Code: **MGPTNK18**



Cut to required shape

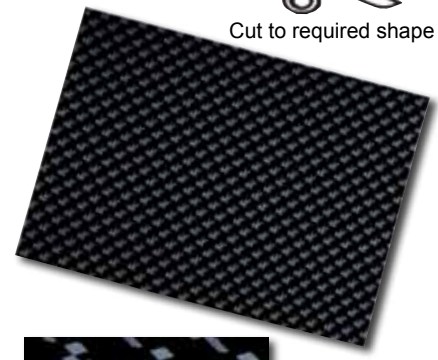

Feature print

### Linear Tank Pads

Linear spine tank pad  
 High quality gloss coating  
 Feature MotoGP design

Order Code	Colour
<b>MGPTNK10</b>	Black
<b>MGPTNK12</b>	Blue
<b>MGPTNK14</b>	Red
<b>MGPTNK16</b>	Green

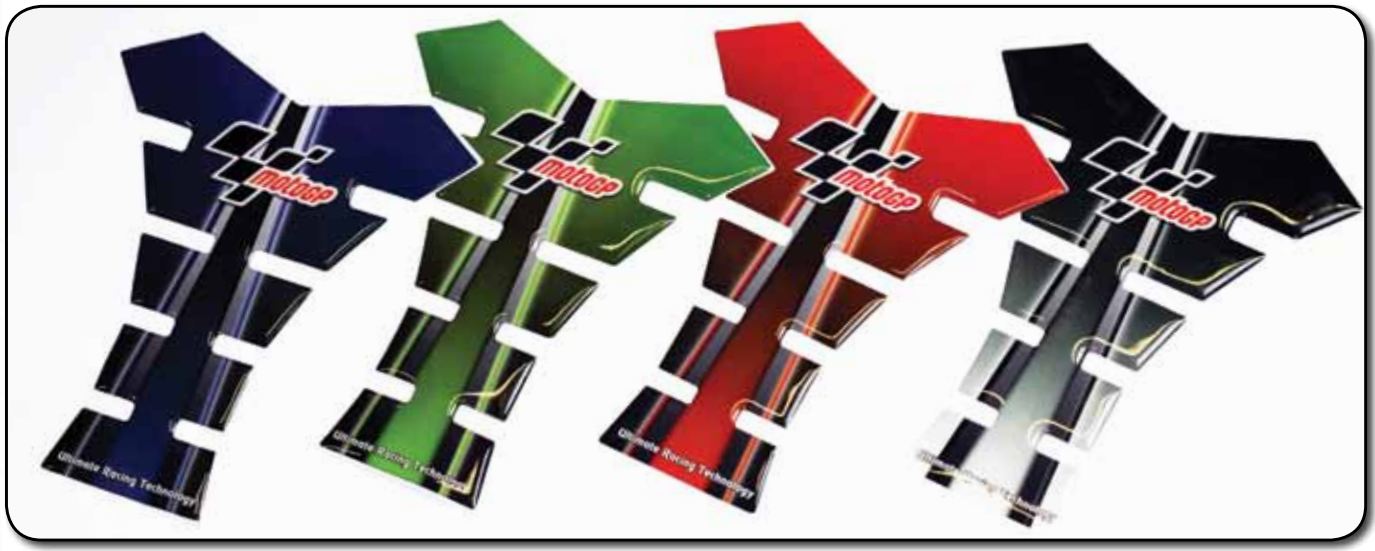

### Tank Protectors

Contoured spine tank pad  
 High quality gloss coating  
 Feature MotoGP design

Order Code	Colour
<b>MGPTNK02</b>	Black
<b>MGPTNK04</b>	Blue
<b>MGPTNK06</b>	Green
<b>MGPTNK08</b>	Red





## Messenger Helmet Bag

Teardrop shaped helmet bag.  
Integral across-body shoulder strap.  
Plenty of storage for helmet, gloves etc.  
Soft protective inner lining.  
Fully padded wall construction.  
2-way front zip closure.



Order Code: **MGPHEL08**



## Helmet Bag

Simple drawstring helmet bag featuring MotoGP design.  
Inexpensive solution to protect expensive lids.

Order Code: **MGPHEL07**



## Tailbag Holdall

This tailbag holdall is shaped specifically to carry and store one crash helmet, and can also be used as a convenient tailbag. Manufactured from robust microfibre outer material, it is fully lined for extra protection. Each side features external compartments for gloves and accessories. When off the bike, the tailbag straps and bunjees can be stored in the base compartment. Complete with shoulder carry strap and storm cover.

Order Code: **MGPHMHBK**



## Garage Pit Mat

Nylon fibred garage and pit work mat with non-slip oil and water resistant PVC backing, as recommended by affiliated racing bodies. Use to show off bikes in the workshop, garage or showroom. Increases safety and comfort when working around the bike.

'Parc fermé' winner printed design.

Order Code: **MGPMAT01**



## Garment Bags

- Motorcycle leathers and textiles are costly and need caring for.
- These bespoke garment bags are oversized to allow motorcycle clothing with armour to be safely stored.
- Each bag is constructed from heavy grade nylon, with robust jumbo full-length zipper.
- Hanger eyelet system allows the bag to be folded securely for carrying by the webbing handles. (Hanger included).
- Ideal for transporting leathers to and from track days.



Order Code **MGPGAR04** Size Full length (for 1 piece leathers)

**MGPGAR02** 3/4 jacket length



3/4 length bag shown

MotoGP

Exhausts

Screens

Commuter

Controls

Headlights

Indicators

Mirrors

Rear Lights

Lifts & Stands

Tools

Batteries & Chargers

Electrics

Chain

Servicing

Tyres & Tubes

Security

Bike Accs

Luggage

Rider Accs

Tank Pads

Extras

MotoGP  
 Exhausts  
 Screens  
 Commuter  
 Controls  
 Headlights  
 Indicators  
 Mirrors  
 Rear Lights  
 Lifts & Stands  
 Tools  
 Batteries & Chargers  
 Electrics  
 Chain  
 Servicing  
 Tyres & Tubes  
 Security  
 Bike Accs  
 Luggage  
 Rider Accs  
 Tank Pads  
 Extras  
 www.bikeit.co.uk

## Rider Mouth Guard

**NEW**

Intended to protect a rider's teeth from the involuntary habit of grinding teeth during riding, this guard fits around the upper teeth and absorbs vibration and shock between the upper and lower jaw.

Use on the track or road.

Complete with hard storage case.

Universal fitting, can be moulded for improved personal fit.

Order Code: **MGPMGD12**



## Beanie Hats

Thermal beanies in two great MotoGP designs.

Order Code	Colour
<b>MGPAT06</b>	Black
<b>MGPAT07</b>	Grey



## Neck Tube

Comfort fit thermal neck tube. Contrast trim and MotoGP embroidered logo. Constructed from 100% cotton (350g).

Order Code: **MGPNTBBK**



## Balaclava

Super comfort fit thermal balaclava with contrast trim and embroidered logo. Constructed from 100% cotton (290g).

Order Code: **MGPBALBK**



## Windproof Neck Tube

Utilising technical material that blocks wind and water, this adjustable neck tube ensures maximum comfort and protection from wind and rain.

Order Code: **MGPNTB07**



## Neo Mask

This ventilated neoprene face mask features a special shaping to fit snugly and offer optimum protection between nose and neck. Velcro neck fastener, contrast trim and logo print.

Order Code: **MGPNEOBK**



## Bandit Mask

Cotton/ Lycra mix stretch-to-fit face mask with bibbed neck. Usable as a neck tube, contrast trim and MotoGP embroidered logo. Constructed from 95% cotton, 5% lycra mix (220g).

Order Code: **MGPBDTBK**





## Teardrop Knee Sliders

Suitable for track and road use. Teardrop shaped MotoGP knee sliders utilise firm grip velcro and solid plastic pucs. Available in Black, Blue and Red.

Order Code    Colour  
**MGPKSL01**    Black  
**MGPKSL02**    Red  
**MGPKSL03**    Blue



## Knee Slider

MotoGP Knee sliders suitable for track and road use. Features a highly durable composite puc with reduced friction properties, offering great surface contact feedback. The puc is bonded to a velcro mounting patch, ready for fitting to leathers. Contoured bespoke left and right sided moulds ensure optimum fitment.

Order Code: **MGPKSL04**

**NEW**

Arriving  
Spring 2013



## Head Tube

A versatile piece of headwear which can be used as a balaclava, bandana, headscarf, face mask and much more! Made from a stretchy cotton-lycra mix, this seamless tube offers optimum comfort for on and off-road bike use. Emblazoned with MotoGP logos and riders.

Order Code: **MGPTUB01**



... as a face mask



... as a pirate cap



... as a neck tube



... as a skull cap

## Visor Track Tints

PC film inserts that stick to the inside of helmet visors. Each film filters transmitted and UV light, the perfect alternative to sunglasses and coloured visors. Each pack contains 1 smoked tint and 1 iridium tint. Universal fit.

MotoGP track tints should only be used during the daytime and not on public highways. Track use only!

Order Code: **MGPTKTIRU**



## Bandana

Versatile bandana with feature MotoGP design.

Simply tie and use as bandana, neck scarf, head or wrist band.

Order Code: **MGPANABK**



MotoGP  
 Exhausts  
 Screens  
 Commuter  
 Controls  
 Headlights  
 Indicators  
 Mirrors  
 Rear Lights  
 Lifts & Stands  
 Tools  
 Batteries & Chargers  
 Electrics  
 Chain  
 Servicing  
 Tyres & Tubes  
 Security  
 Bike Accs  
 Luggage  
 Rider Accs  
 Tank Pads  
 Extras



## Rider Braces

Elasticated rider braces featuring MotoGP detail logo print. Jumbo width elastic for increased comfort. Fully adjustable for all rider heights. Over-sized waist clamps suitable for use on jeans, textile trousers and leathers.

Order Code: **MGPBRC12**

**NEW**



## Everyday Socks

Quality cotton mix everyday socks featuring MotoGP design. Adult free-size. Available in single and multi-packs.

Order Code	Description
<b>MGPSOC03</b>	1 pair black
<b>MGPSOC07</b>	3 pair pack (black, blue and grey)



## Boxer Shorts

Men's cotton/spandex mix boxer shorts feature longer length legs and MotoGP decal.

Order Code	Size
<b>MGPBXS04</b>	33-35" (M)
<b>MGPBXS05</b>	36-38" (L)
<b>MGPBXS06</b>	39-42" (XL)



## Boot Socks

Ultra comfort knee length socks, specifically designed for use with motorcycle boot wear.

- Loop knit for comfort.
- Maximum cushioning & support.
- Fitted ankle to minimise slippage.
- Available in thick thermal winter and light gauge summer versions.



**WINTER BOOT SOCKS**  
Adult Free Size

Order Code: **MGPSOCWIN**



**SUMMER BOOT SOCKS**  
Adult Free Size

Order Code: **MGPSOCSUM**



**RACE BOOT SOCKS**  
Adult Free Size

Order Code: **MGPSOC05**

## Travel Mug

11oz / 312ml polymer travel mug, features anti-spill lid and wide handle. Finished with the new MotoGP 'motion' graphic and logo.

Order Code:  
**MGPMUG13**

**NEW**



## Coffee Cups

Stylish ceramic coffee cups, featuring the new MotoGP 'motion' graphic and logo. Available as 12oz Latte and 6oz Espresso sizes.

Order Code    Description  
**MGPMUG14**    Latte Cup 12oz  
**MGPMUG15**    Espresso Cup 6oz

**NEW**



## Drinks Glass

Hot and cold drinks glass, featuring the new MotoGP 'motion' graphic and logo.

Order Code: **MGPMUG16**

**NEW**



## Mugs

Bright stoneware mugs with feature print designs.

Order Code    Description  
**MGPMUG11**    Tower of champions  
**MGPMUG12**    Rider pictures



## Bottle Cooler

Novelty neoprene bottle cover with zip closure

Fits over chilled drinks bottle, keeping bottle cooler for longer and making the bottle non-slip

Order Code: **MGPCAN11**



Back with zip



## Can Coolers

These neoprene covers insulate chilled cans preventing them warming up and slipping out of hands!

Each pack contains one black and one red cooler, with MotoGP detail print. Drinks not included!

Order Code: **MGPCAN07**



## Drink Bottle

500ml drink bottle with extendable tube and cap.

Order Code:  
**MGPBOT09**



MotoGP  
Exhausts  
Screens  
Commuter  
Controls  
Headlights  
Indicators  
Mirrors  
Rear Lights  
Lifts & Stands  
Tools  
Batteries & Chargers  
Electrics  
Chain  
Servicing  
Tyres & Tubes  
Security  
Bike Accs  
Luggage  
Rider Accs  
Tank Pads  
Extras



## PVC Printed Keyrings

Fantastic photographic quality keyfobs detailing in-race shots of MotoGP's best. Features carbon effect MotoGP print on reverse. Metal ring fitment.

Order Code	Description
MGPKEY83	Jorge Lorenzo
MGPKEY84	Casey Stoner
MGPKEY85	Ben Spies
MGPKEY86	Valentino Rossi
MGPKEY87	Dani Pedrosa
MGPKEY88	Nicky Hayden
MGPKEY89	Andrea Dovizioso
MGPKEY90	Cal Crutchlow
MGPKEY91	Stefan Bradl

**NEW**



## Retro Rubber Keyrings

Rubber moulded keyfobs with retro vector rider images. Metal ring fitment.

Order Code	Description
MGPKEY10	Legends, Freddie Spencer #1
MGPKEY11	Legends, Kenny Roberts #1
MGPKEY12	Legends, Kevin Schwantz #34
MGPKEY14	Valentino Rossi Gauloises Fortuna Yamaha
MGPKEY34	Valentino Rossi Laguna Seca
MGPKEY43	Valentino Rossi Camel Yamaha
MGPKEY46	Valentino Rossi Fiat Yamaha
MGPKEY54	Loris Capirossi Rizla Suzuki



MGPKEY10

MGPKEY11

MGPKEY12



## PVC Printed Keyrings

Fantastic photographic quality keyfobs detailing in-race shots of MotoGP's best. Features carbon effect MotoGP print on reverse. Metal ring fitment.

Order Code	Description
<b>MGPKEY72</b>	Andrea Dovizioso #4 / Repsol Honda
<b>MGPKEY73</b>	Nicky Hayden #69 / Ducati Team
<b>MGPKEY74</b>	Colin Edwards #5 / Monster Yamaha Tech 3
<b>MGPKEY75</b>	Jorge Lorenzo #1 / Yamaha Factory Racing
<b>MGPKEY76</b>	Dani Pedrosa #26 / Repsol Honda Team
<b>MGPKEY77</b>	Valentino Rossi # 46 "Knee Down" / Ducati Team
<b>MGPKEY78</b>	Valentino Rossi # 46 "Tuck" / Ducati Team
<b>MGPKEY79</b>	Marco Simoncelli #58 / San Carlo Honda Gresini
<b>MGPKEY80</b>	Ben Spies #11 / Yamaha Factory Racing



## Logo Keyrings

Official MotoGP keyfobs, in variety of fitments and functions

Order Code	Description
<b>MGPKEY61</b>	Premium metal keyfob with injected colour logo. Metal ring fitment.
<b>MGPKEY26</b>	Rubber keyfob with colour logo. Metal ring fitment.
<b>MGPKEY44</b>	Carabiner style keyfob, great for belt loops. Metal ring fitment.
<b>MGPKEY82</b>	Neck lanyard with quick release buckle. Clasp fitment suitable for keys, mobile phones, ID and paddock passes etc.



MotoGP

Exhausts

Screens

Commuter

Controls

Headlights

Indicators

Mirrors

Rear Lights

Lifts & Stands

Tools

Batteries & Chargers

Electrics

Chain

Servicing

Tyres & Tubes

Security

Bike Accs

Luggage

Rider Accs

Tank Pads

Extras

## Rider Paddock Chair

- Unique styling rider's paddock chair
- Deep support seat and back utilising memory foam
- Durable construction and high detail stitching
- Integrated shoulder and thigh supports
- Fully adjustable tilt and recline action
- Pneumatic height adjuster
- Carbon Fibre effect vinyl upholstery
- Chromed base with 5 swivel casters

Order Code:  
**MGPCHR01**



Perfect in home studies and at computer desks.  
Great in showrooms and waiting areas!



## Sticker Set

25 piece sticker set of MotoGP riders and logos.

Order Code: **MGPSET01**



\* Design may vary

## Track & Paddock Umbrella

Deluxe paddock umbrella with MotoGP logos feature print. (75cm radius shell, sponge handle, carbon fibre shaft)

Order Code: **MGPUMB06**



## Parking Sign

Aluminium punched parking sign, with feature print. 205mm x 290mm, pre drilled for mounting.

Order Code: **MGPSIG10**



## Ladies Automatic Umbrella

Eye catching ladies automatic umbrella featuring MotoGP print. Handle mechanism makes for easy opening and closing. Complete with storage case. Size: 50cm radius

Order Code: **MGPUMB04**



## Doormat

This novelty doormat is a must-have for any serious MotoGP fan. Non-slip backing and robust top material. Great at home and in showrooms!

Approx size : 40cm x 60cm

Order Code: **MGPMAT03**







## HOMOLOGATED APPROVED SYSTEMS

*Black*  
//SERIES//



### Road Black Series Carbon Fibre Slip-on Systems

Dyno tuned and track tested, like all TBR exhausts, the Black Series are aimed at those who want absolute top level performance without sacrificing good looks. All systems include filament wound seamless carbon fibre, stainless steel slip-tubes, and magnesium endcaps.

MAKE & MODEL	YEAR	ORDER CODE
<b>HONDA</b>		
CBR600RR	03-04	<i>E005-110407VE-B</i>
CBR600RR	05-06	<i>E005-120407ME-B</i>
CBR600RR	07-12	<i>E005-1750407VE-B</i>
CB1000	08-11	<i>E005-2840407VE-B</i>
Hornet 600	08-10	<i>E005-2310407VE-B</i>
<b>KAWASAKI</b>		
ZX-6R	09-12	<i>E005-2410407V2E-B</i>
<b>SUZUKI</b>		
GSX-R600/750	08-10	<i>E005-2130407VE-B</i>
GSX-R1000	09-11	<i>E005-2420407DVE-B</i>
<b>YAMAHA</b>		
FZ8	11	<i>E005-3050407VE-B</i>
R6	06-12	<i>E005-1460407VE-B</i>
R1	09-12	<i>E005-2380407VE-B</i>



Easily removable EU baffle



CNC AL Inlet with EU cert engraving



NB: Each Two Brothers exhaust system includes carbon fibre can and connecting link pipes as required



- Motorcycle
- Exhausts
- Screens
- Commuter
- Controls
- Headlights
- Indicators
- Mirrors
- Rear Lights
- Lifts & Stands
- Tools
- Batteries & Chargers
- Electrics
- Chain
- Servicing
- Tyres & Tubes
- Security
- Bike Accs
- Luggage
- Rider Accs
- Tank Pads
- Extras



# VIPER

## RACE CANS

VIPER BY NAME - VIPER BY NATURE



"MAXIMUM POWER & TORQUE - IN STYLE"

*Viper Race Cans present a wide range of road and sports bike exhausts, offering stylish upgrades to original exhausts with increased performance*

- Reduced weight over original cans
- Increase in power output and torque
- Easy to fit slip-on and bolt-on cans
- Low maintenance
- Unique race acoustic

*Developed and manufactured in an original equipment facility, Viper Race Cans utilise optimum materials such as stainless steel and carbon fibre to guarantee exhaust cans of unfaltering build quality.*

*Formats available cater for all needs and budgets from 'straight-through' Alloy Round cans to road legal E-marked Carbon Fibre cans with end-cap and removable baffle. Whether the bike is a daily commuter or track machine, Viper provides plenty of choices in can shape, material and size.*

**Straight-through Race Can formats;**

- Alloy - Round / Oval / Stubby Oval / Micro Oval / Stubby Oval with Carbon end-cap / Micro Oval with Carbon end-cap
- Carbon Fibre - Oval

**E-marked Can with removable baffle formats;**

- Alloy - Round / Oval / Oval with Carbon Fibre end-cap
- Carbon Fibre - Oval / Oval with Carbon Fibre end-cap

[WWW.VIPERRACECANS.COM](http://WWW.VIPERRACECANS.COM)



## Viper Spares

Replacement can straps to hang exhaust cans from footrest hangers and banjo clamps to secure connecting pipes to slip-on cans and down-pipes.

### Can Straps

Order Code	Description
<b>EXCSTB</b>	28mm hanger 365mm circumference
<b>EXCSTC</b>	43mm hanger 365mm circumference
<b>EXCSTD</b>	48mm angled hanger 370mm circumference



### Banjo Clamps

Order Code	Description
<b>BAN2931</b>	Banjo clamp 29-31mm
<b>BAN3134</b>	Banjo clamp 31-34mm
<b>BAN3437</b>	Banjo clamp 34-37mm
<b>BAN3740</b>	Banjo clamp 37-40mm
<b>BAN4043</b>	Banjo clamp 40-43mm
<b>BAN4447</b>	Banjo clamp 44-47mm
<b>BAN4851</b>	Banjo clamp 48-51mm
<b>BAN5255</b>	Banjo clamp 52-55mm
<b>BAN5559</b>	Banjo clamp 55-59mm
<b>BAN5963</b>	Banjo clamp 59-63mm
<b>BAN6368</b>	Banjo clamp 63-68mm



## Exhaust Packing Sheets

Easy-use sheets of sound absorption media, manufactured from highly voluminised continuous filament glass yarn using sophisticated texturisation techniques. Suitable for both street and off-road applications.

The material is uniquely compressed and stitched together with a fine low temperature melting thread, which dissolves on contact with exhaust gas, releasing the compressed fibres to expand and fully fill chamber voids. Ideally suited for repacking non-uniform shaped cans such as oval and tri-oval, which can be tricky to repack correctly with standard materials.

### Easy to use;

- > available in 3 lengths to suit most popular exhaust sizes (length can also be trimmed for precision)
- > no need to use stainless steel wool to cover the perforated pipe
- > simply wrap sheet around the perforated pipe and cut to attain the required fill volume (each sheet is 1M wide)

### Material benefits;

- > higher temperature resistance (up to 1000°C), eliminating need for s/s wool
- > high resistance to High Pulse Compacting
- > increased sound absorption compared to traditional materials
- > improved thermal insulation - reduced need for internal or external heat shields
- > more efficient than conventional needle mat or blown-in fibre products

Order Code	Size
<b>EXCPCK350</b>	350mm x 1M
<b>EXCPCK400</b>	400mm x 1M
<b>EXCPCK450</b>	450mm x 1M

Fibres compressed by melting thread



Fibres expanded after thread has melted

## Centre Stand Stopper

Rubber stopper with allen bolt fitting, replaces or upgrades existing stopper to protect bike stand pipe contact with link pipe.

Order Code:  
**EXCRUB01**



## dB Killer

Designed for use with Viper oval and round cans this angled dB Killer simply bolts into the end of Viper cans to reduce noise emission.

Order Code: **EXCKILL**

N.B. Requires drilling at exhaust outlet nozzle.



## Can Shield

This carbon fibre shield simply straps over Viper oval cans, protecting covered area from impact knocks and scratches.

Can be located anywhere along the can, especially effective on the front end, the most common point of impact when bike is dropped or crashed\*.

Order Code: **EXCPROA**

\* Viper Can Shield helps to minimise damage to cans, it is not a guarantee of no damage.



## Baffle Kit

BS Approved easy to install / un-install universal Viper can baffle, inserts into end section of straight-through cans, simple bolt fixing secures baffle in place. Any protruding baffle can be easily trimmed to fit flush with the exhaust nozzle.

N.B. Fitting requires drilling hole into nozzle of exhaust can.

Dimensions:

A = 48mm

B = 28mm

C = 32mm

Order Code:  
**EXCNRK**

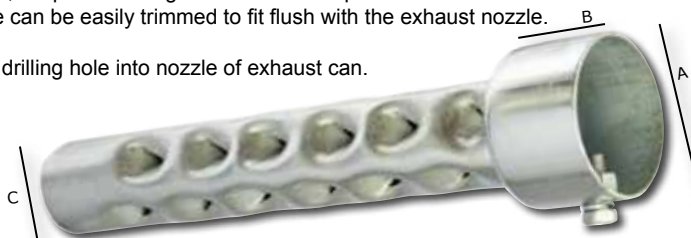

Motocp  
Exhausts  
Screens  
Commuter  
Controls  
Headlights  
Indicators  
Mirrors  
Rear Lights  
Lifts & Stands  
Tools  
Batteries & Chargers  
Electrics  
Chain  
Servicing  
Tyres & Tubes  
Security  
Bike Accs  
Luggage  
Rider Accs  
Tank Pads  
Extras

## Viper Race Cans - Unbaffled for track use only

MAKE & MODEL	YEAR	ALLOY ROUND	ALLOY OVAL	UNDERSEAT ALLOY OVAL	CARBON FIBRE OVAL	ALLOY OVAL STUBBY (39CM)
--------------	------	-------------	------------	----------------------	-------------------	--------------------------



### APRILIA

Falco SL1000	00>	EXC101	EXC901	n/a	n/a	EXC701
RSV4	10>	EXC101	EXC901	n/a	n/a	EXC701
RSV Mille R	03>	EXC101	EXC901	n/a	n/a	EXC701
RSV Mille Factory	04>	EXC101	EXC901	n/a	n/a	EXC701
RSV Mille	98-04	EXC101	EXC901	n/a	n/a	EXC701
RSV Tuono	98-04	EXC101	EXC901	n/a	n/a	EXC701
Tuono 1000	06>	EXC101	EXC901	n/a	n/a	EXC701

### BMW

F800 GS	08>	EXC101	EXC901	n/a	EXC501	EXC701
F800 R	09-12	EXC101	EXC901	n/a	EXC501	EXC701
R1200 GS Adventure	06-09	EXC101	EXC901	n/a	EXC501	EXC701
R1200 GS	04-09	EXC101	EXC901	n/a	EXC501	EXC701
R1200 ST	05>	EXC101	EXC901	n/a	EXC501	EXC701
R1200 RT	05>	EXC101	EXC901	n/a	EXC501	EXC701
K1300 S/R/S HP	08-12	EXC101	EXC901	n/a	EXC501	EXC701

### DUCATI

600 Monster	95-03	EXC101	EXC901	n/a	n/a	EXC701
600SS	93-01	EXC101	EXC901	n/a	n/a	EXC701
750 Monster	93-03	EXC101	EXC901	n/a	n/a	EXC701
750SS	90-98	EXC101	EXC901	n/a	n/a	EXC701
900 Monster	93-03	EXC101	EXC901	n/a	n/a	EXC701
900SS	93-03	EXC101	EXC901	n/a	n/a	EXC701
1000 Monster	04-06	EXC101	EXC901	n/a	n/a	EXC701

### HONDA

VFR400 NC21	85-88	EXC101	EXC901	n/a	EXC501	EXC701
VFR400 NC30	89-93	EXC101	EXC901	n/a	EXC501	EXC701
CB500	94-03	EXC101	EXC901	n/a	EXC501	EXC701
CBF500	04-06	EXC101	EXC901	n/a	EXC501	EXC701
CB600 Hornet	98-02	EXC101	EXC901	n/a	EXC501	EXC701
CB600F Hornet	03-06	EXC101	EXC901	n/a	EXC501	EXC701
CB600F Hornet	07-12	EXC101	EXC901	n/a	EXC501	EXC701
CBF600	04-07	EXC101	EXC901	n/a	EXC501	EXC701
CBF600	08>	EXC101	EXC901	n/a	EXC501	EXC701
CBR600 FH-FL	87-90	EXC101	EXC901	n/a	EXC501	EXC701
CBR600 FM-FR	91-94	EXC101	EXC901	n/a	EXC501	EXC701
CBR600 FS-FW	94-98	EXC101	EXC901	n/a	EXC501	EXC701
CBR600 FX FY	99-00	EXC101	EXC901	n/a	EXC501	EXC701
CBR600 F1	00-01	EXC101	EXC901	n/a	EXC501	EXC701
CBR600 F (with centre stand)	01-05	EXC101	EXC901	n/a	EXC501	EXC701
CBR600 FS Sport	01-05	EXC101	EXC901	n/a	EXC501	EXC701
CBR600RR	03-04	n/a	n/a	EXCUS30	n/a	n/a
CBR600RR	05-06	n/a	n/a	EXCUS30	n/a	n/a
CBR600RR	07-08	n/a	n/a	EXCUS30	n/a	n/a
VFR750F R-V	94-97	EXC101	EXC901	n/a	EXC501	EXC701
VFR800 Fi W-1	97-02	EXC101	EXC901	n/a	EXC501	EXC701
VFR800 VTEC	02>	n/a	n/a	n/a	n/a	EXC701
CB900 Hornet	01>	EXC101	EXC901	n/a	EXC501	EXC701
CBR900RR N-S (898)	92-95	EXC103	EXC903	n/a	EXC503	n/a
CBR900RR T-X (918)	96-99	EXC104	EXC904	n/a	EXC504	n/a
CBR900RR Y123	00-03	EXC112	EXC912	n/a	EXC512	n/a
CB1000 P-T Big One	92-97	EXC103	EXC903	n/a	EXC503	n/a
CB1000 R	08>	EXC101	EXC901	n/a	EXC501	EXC701
CBR1000 FH-FX **	87-99	EXC101	EXC901	n/a	EXC501	EXC701
CBR1000RR	04-05	n/a	n/a	EXCUS30	n/a	n/a
CBR1000RR	06-07	n/a	n/a	EXCUS30	n/a	n/a
CBR1000RR	08>	EXC101	EXC901	n/a	EXC501	EXC701
CBF1000	05>	EXC101	EXC901	n/a	EXC501	EXC701
VTR1000 Firestorm FV-F4	97-05	EXC101	EXC901	n/a	n/a	EXC701

\*\* Conversion to single can - requires blanking plug - not supplied.



ALLOY OVAL  
STUBBY (39CM) WITH  
CARBON FIBRE  
END CAP

ALLOY OVAL  
MICRO (20CM)

ALLOY OVAL  
MICRO (20CM) WITH  
CARBON FIBRE  
END CAP

CAN TYPE

CAN QTY  
REQUIRED

LINK PIPE

**VIPER**

To order;  
1> Select bike model  
2> Choose can type & order  
correct qty as detailed  
3> Order link pipe if required

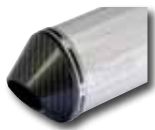

EXC001	EXC601	EXC631	Slip-On	2	CNP703
EXC001	EXC601	EXC631	Slip-On	1	CNP704
EXC001	EXC601	EXC631	Slip-On	2	CNP702
EXC001	EXC601	EXC631	Slip-On	2	CNP702
EXC001	EXC601	EXC631	Slip-On	1	CNP701
EXC001	EXC601	EXC631	Slip-On	1	CNP701
EXC001	EXC601	EXC631	Slip-On	2	CNP702
EXC001	EXC601	EXC631	Slip-On	1	CNP801
EXC001	EXC601	EXC631	Slip-On	1	CNP805
EXC001	EXC601	EXC631	Slip-On	1	CNP802
EXC001	EXC601	EXC631	Slip-On	1	CNP802
EXC001	EXC601	EXC631	Slip-On	1	CNP803
EXC001	EXC601	EXC631	Slip-On	1	CNP804
EXC001	EXC601	EXC631	Slip-On	1	CNP806
EXC001	EXC601	EXC631	Slip-On	2	CNP101
EXC001	EXC601	EXC631	Slip-On	1	CNP102
EXC001	EXC601	EXC631	Slip-On	2	CNP101
EXC001	EXC601	EXC631	Slip-On	2	CNP106
EXC001	EXC601	EXC631	Slip-On	2	CNP101
EXC001	EXC601	EXC631	Slip-On	2	CNP105
EXC001	EXC601	EXC631	Slip-On	2	CNP107
EXC001	EXC601	EXC631	Slip-On	1	CNP204
EXC001	EXC601	EXC631	Slip-On	1	CNP206
EXC001	EXC601	EXC631	Slip-On	1	CNP223
EXC001	EXC601	EXC631	Slip-On	1	CNP222
EXC001	EXC601	EXC631	Slip-On	1	CNP201
EXC001	EXC601	EXC631	Slip-On	1	CNP216
EXC001	EXC601	EXC631	Slip-On	1	CNP233
EXC001	EXC601	EXC631	Slip-On	1	CNP221
EXC001	EXC601	EXC631	Slip-On	1	CNP224
EXC001	EXC601	EXC631	Slip-On	1	CNP209
EXC001	EXC601	EXC631	Slip-On	1	CNP202
EXC001	EXC601	EXC631	Slip-On	1	CNP202
EXC001	EXC601	EXC631	Slip-On	1	CNP215
EXC001	EXC601	EXC631	Slip-On	1	CNP213
EXC001	EXC601	EXC631	Slip-On	1	CNP212
EXC001	EXC601	EXC631	Slip-On	1	CNP214
n/a	n/a	n/a	Slip-On	1	CNP230
n/a	n/a	n/a	Slip-On	1	CNP231
n/a	n/a	n/a	Slip-On	1	CNP232
EXC001	EXC601	EXC631	Slip-On	1	CNP207
EXC001	EXC601	EXC631	Slip-On	1	CNP208
EXC001	n/a	n/a	Slip-On	2	CNP227
EXC001	EXC601	EXC631	Slip-On	2	CNP219
n/a	n/a	n/a	3 Bolt	1	NOT REQ
n/a	n/a	n/a	3 Bolt	1	NOT REQ
n/a	n/a	n/a	3 Bolt	1	NOT REQ
n/a	n/a	n/a	3 Bolt	1	NOT REQ
EXC001	EXC601	EXC631	Slip-On	1	CNP225
EXC001	EXC601	EXC631	Slip-On	1	CNP203
n/a	n/a	n/a	Slip-On	1	CNP228
n/a	n/a	n/a	Slip-On	1	CNP229
EXC001	EXC601	EXC631	Slip-On	1	CNP226
EXC001	EXC601	EXC631	Slip-On	2	CNP220
EXC001	EXC601	EXC631	Slip-On	2	CNP210

Viper Race Cans are constructed as a 'straight-through' system, unbaffled for track use. Available in eight shape and material options, including alloy and carbon fibre.

- MotorGP
- Exhausts
- Screens
- Commuter
- Controls
- Headlights
- Indicators
- Mirrors
- Rear Lights
- Lifts & Stands
- Tools
- Batteries & Chargers
- Electrics
- Chain
- Servicing
- Tires & Tubes
- Security
- Bike Accs
- Luggage
- Rider Accs
- Tank Pads
- Extras

## Viper Race Cans - Unbaffled for track use only

MAKE & MODEL	YEAR	ALLOY ROUND	ALLOY OVAL	UNDERSEAT ALLOY OVAL	CARBON FIBRE OVAL	ALLOY OVAL STUBBY (39CM)
--------------	------	-------------	------------	----------------------	-------------------	--------------------------



### HONDA cont...

VTR1000 SP1	97-02	EXC101	EXC901	n/a	n/a	EXC701
VTR1000 SP2	02-03	EXC101	EXC901	n/a	n/a	EXC701
CBR1100 XX B/BIRD	96-08	EXC101	EXC901	n/a	EXC501	EXC701
CB1100 X11	99-02	EXC101	EXC901	n/a	EXC501	EXC701
CB1300 F/A	03-06	EXC101	EXC901	n/a	EXC501	EXC701

### KAWASAKI

Ninja 250R (ZX250)	ALL	EXC101	EXC901	n/a	EXC501	EXC701
ZX-6R Ninja F1,2,3	95-97	EXC105	n/a	n/a	n/a	n/a
ZX-6R Ninja G1-2	98-00	EXC108	EXC908	n/a	EXC508	n/a
ZX-6R Ninja J1-2 A1P	00-02	EXC108	EXC908	n/a	EXC508	n/a
ZX-6R Ninja 636 B1H-M1H	03-04	EXC101	EXC901	n/a	EXC501	EXC701
ZZ-R600 E	93-04	EXC102	n/a	n/a	n/a	n/a
ZR-7 / S	99-05	EXC106	EXC906	n/a	EXC506	n/a
ZX-7R Ninja ZX-7RR	96-04	EXC106	EXC906	n/a	EXC506	n/a
ZXR750 JKLM	89-96	EXC106	EXC906	n/a	EXC506	n/a
Z750/S	04-06	EXC101	EXC901	n/a	EXC501	EXC701
Z750/S	07>	EXC101	EXC901	n/a	EXC501	EXC701
ZX-9R Ninja B1,2,3,4	94-97	EXC101	EXC901	n/a	EXC501	EXC701
ZX-9R Ninja C	98-99	EXC107	EXC907	n/a	EXC507	n/a
ZX-9R Ninja E	00-01	EXC101	EXC901	n/a	EXC501	EXC701
ZX-9R Ninja F	02-05	EXC101	EXC901	n/a	EXC501	EXC701
ZX-10R Ninja C	04-05	EXC101	EXC901	n/a	EXC501	EXC701
ZX-10R	10>	EXC101	EXC901	n/a	EXC501	EXC701
Versys 1000	12>	EXC101	EXC901	n/a	EXC501	EXC701
Z1000	03-06	EXC101	EXC901	n/a	EXC501	EXC701
Z1000	07-09	EXC101	EXC901	n/a	EXC501	EXC701
Z1000 / SX	10>	EXC101	EXC901	n/a	EXC501	EXC701
ZZR1200	ALL	EXC101	EXC901	n/a	EXC501	EXC701
GTR1400	07>	EXC101	EXC901	n/a	EXC501	EXC701
ZZR1400	06-07	EXC101	EXC901	n/a	EXC501	EXC701
ZZR1400	08-11	EXC101	EXC901	n/a	EXC501	EXC701
ZZR1400	12	EXC101	EXC901	n/a	EXC501	EXC701

### KTM

690 Duke	12>	EXC101	EXC901	n/a	EXC501	EXC701
690 Duke (De-Cat)	12>	EXC101	EXC901	n/a	EXC501	EXC701

### SUZUKI

GSF600 Bandit	95-99	EXC101	EXC901	n/a	EXC501	EXC701
GSF600 Bandit	00-06	EXC101	EXC901	n/a	EXC501	EXC701
GSF650 Bandit	05-06	EXC101	EXC901	n/a	EXC501	EXC701
GSF650 Bandit	07>	EXC101	EXC901	n/a	EXC501	EXC701
GSX600F	97-04	EXC101	EXC901	n/a	EXC501	EXC701
GSX650F	08>	EXC101	EXC901	n/a	EXC501	EXC701
GSX-R600 RV-RY	96-00	EXC103	EXC903	n/a	EXC503	n/a
GSX-R600 K1-K5	01-05	n/a	EXC913	n/a	EXC513	n/a
GSX-R600 High Level	06-07	EXC101	EXC901	n/a	EXC501	EXC701
GSX-R600 K8-L0	08-10	EXC101	EXC901	n/a	EXC501	EXC701
GSX-R600	11>	EXC101	EXC901	n/a	EXC501	EXC701
RF600R S	93-97	EXC109	EXC909	n/a	EXC509	n/a
SV650 /S X-K2 §	98-02	EXC101	EXC901	n/a	EXC501	EXC701
SV650 /S §	03>	EXC101	EXC901	n/a	EXC501	EXC701
GSR 750	11>	EXC101	EXC901	n/a	EXC501	EXC701
GSX750F	97-04	EXC101	EXC901	n/a	EXC501	EXC701
GSX-R750 T-X	96-99	EXC103	EXC903	n/a	EXC503	n/a
GSX-R750 Y	00	EXC110	EXC910	n/a	EXC510	n/a
GSX-R750 K1-K5	01-05	n/a	EXC913	n/a	EXC513	n/a
GSX-R750 High Level	06-07	EXC101	EXC901	n/a	EXC501	EXC701
GSX-R750 K8-L0	08-10	EXC101	EXC901	n/a	EXC501	EXC701

§ Requires cutting of original link pipe

ALLOY OVAL  
STUBBY (39CM) WITH  
CARBON FIBRE  
END CAP

ALLOY OVAL  
MICRO (20CM)

ALLOY OVAL  
MICRO (20CM) WITH  
CARBON FIBRE  
END CAP

CAN TYPE

CAN QTY  
REQUIRED

LINK PIPE

**VIPER**

To order;  
1> Select bike model  
2> Choose can type & order  
correct qty as detailed  
3> Order link pipe if required



EXC001	EXC601	EXC631	Slip-On	2	CNP217
EXC001	EXC601	EXC631	Slip-On	2	CNP218
EXC001	EXC601	EXC631	Slip-On	2	CNP211
EXC001	EXC601	EXC631	Slip-On	2	CNP211
EXC001	EXC601	EXC631	Slip-On	1	CNP205
EXC001	EXC601	EXC631	Slip-On	1	CNP315
n/a	n/a	n/a	3 Bolt	1	NOT REQ
n/a	n/a	n/a	3 Bolt	1	NOT REQ
n/a	n/a	n/a	3 Bolt	1	NOT REQ
EXC001	EXC601	EXC631	Slip-On	1	CNP305
n/a	n/a	n/a	Slip-On	2	CNP304
n/a	n/a	n/a	3 Bolt	1	NOT REQ
n/a	n/a	n/a	3 Bolt	1	NOT REQ
EXC001	EXC601	EXC631	Slip-On	1	CNP306
EXC001	EXC601	EXC631	Slip-On	1	CNP314
EXC001	EXC601	EXC631	Slip-On	1	CNP301
n/a	n/a	n/a	3 Bolt	1	NOT REQ
EXC001	EXC601	EXC631	Slip-On	1	CNP307
EXC001	EXC601	EXC631	Slip-On	1	CNP308
EXC001	EXC601	EXC631	Slip-On	1	CNP309
EXC001	EXC601	EXC631	Slip-On	1	CNP319
EXC001	EXC601	EXC631	Slip-On	1	CNP321
EXC001	EXC601	EXC631	Slip-On	2	CNP310
EXC001	EXC601	EXC631	Slip-On	2	CNP312
EXC001	EXC601	EXC631	Slip-On	2	CNP320
EXC001	EXC601	EXC631	Slip-On	2	CNP316
EXC001	EXC601	EXC631	Slip-On	1	CNP318
EXC001	EXC601	EXC631	Slip-On	2	CNP311
EXC001	EXC601	EXC631	Slip-On	2	CNP317
EXC001	EXC601	EXC631	Slip-On	2	CNP322
EXC001	EXC601	EXC631	Slip-On	1	CNP901
EXC001	EXC601	EXC631	Slip-On	1	CNP902
EXC001	EXC601	EXC631	Slip-On	1	CNP401
EXC001	EXC601	EXC631	Slip-On	1	CNP407
EXC001	EXC601	EXC631	Slip-On	1	CNP407
EXC001	EXC601	EXC631	Slip-On	1	CNP415
EXC001	EXC601	EXC631	Slip-On	1	CNP401
EXC001	EXC601	EXC631	Slip-On	1	CNP415
n/a	n/a	n/a	3 Bolt	1	NOT REQ
n/a	n/a	n/a	4 Bolt	1	NOT REQ
EXC001	EXC601	EXC631	Slip-On	1	CNP422
EXC001	EXC601	EXC631	Slip-On	1	CNP414
EXC001	EXC601	EXC631	Slip-On	1	CNP421
n/a	n/a	n/a	3 Bolt	1	NOT REQ
EXC001	EXC601	EXC631	Slip-On	1	CNP406
EXC001	EXC601	EXC631	Slip-On	1	CNP410
EXC001	EXC601	EXC631	Slip-On	1	CNP426
EXC001	EXC601	EXC631	Slip-On	1	CNP401
n/a	n/a	n/a	3 Bolt	1	NOT REQ
n/a	n/a	n/a	4 Bolt	1	NOT REQ
n/a	n/a	n/a	4 Bolt	1	NOT REQ
EXC001	EXC601	EXC631	Slip-On	1	CNP422
EXC001	EXC601	EXC631	Slip-On	1	CNP414

Viper Race Cans are constructed as a 'straight-through' system, unbaffled for track use. Available in eight shape and material options, including alloy and carbon fibre.

MotorGP  
Exhausts  
Screens  
Commuter  
Controls  
Headlights  
Indicators  
Mirrors  
Rear Lights  
Lifts & Stands  
Tools  
Batteries & Chargers  
Electrics  
Chain  
Servicing  
Tyres & Tubes  
Security  
Bike Accs  
Luggage  
Rider Accs  
Tank Pads  
Extras



# Viper Race Cans - Unbaffled for track use only

MAKE & MODEL      YEAR      ALLOY ROUND      ALLOY OVAL      UNDERSEAT ALLOY OVAL      CARBON FIBRE OVAL      ALLOY OVAL STUBBY (39CM)



## SUZUKI cont...

GSX-R750 L1	11	EXC101	EXC901	n/a	EXC501	EXC701
RF900R	94-99	EXC109	EXC909	n/a	EXC509	n/a
GSX-R1000 K1-K4	01-04	n/a	EXC913	n/a	EXC513	n/a
GSX-R1000 K5 K6	05-06	EXC101	EXC901	n/a	EXC501	EXC701
GSX-R1000 K7 K8	07-08	EXC101	EXC901	n/a	EXC501	EXC701
GSX-R1000 K9-L1	09-11	EXC101	EXC901	n/a	EXC501	EXC701
GSX-R1000 L2	12	EXC101	EXC901	n/a	EXC501	EXC701
DL1000 VSTROM	02>	EXC101	EXC901	n/a	n/a	EXC701
SV1000 /S	03-06	EXC110	EXC910	n/a	n/a	n/a
TL1000 S/R	97-04	EXC110	EXC910	n/a	n/a	n/a
GSX-R1100 Slingshot KLMN	89-93	EXC102	n/a	n/a	n/a	n/a
GSF1200 Bandit T-Y	96-00	EXC109	EXC909	n/a	EXC509	n/a
GSF1200 Bandit K1-K4	00-04	n/a	EXC914	n/a	EXC514	n/a
GSF1200 Bandit/SA K5-K6	04-06	EXC101	EXC901	n/a	EXC501	EXC701
GSF1250 Bandit	07>	EXC101	EXC901	n/a	EXC501	EXC701
GSF1250 Bandit GT	07>	EXC101	EXC901	n/a	EXC501	EXC701
GSX1250 F	10>	EXC101	EXC901	n/a	EXC501	EXC701
GSX1300 B King	08>	n/a	n/a	EXCUS30	n/a	n/a
GSX-R1300 Hayabusa	99-07	EXC103	EXC903	n/a	EXC503	n/a
GSX-R1300 Hayabusa	08>	EXC101	EXC901	n/a	EXC501	EXC701
GSX1400 K2-K4	01-04	EXC101	EXC901	n/a	EXC501	EXC701
GSX1400 K5	05>	EXC101	EXC901	n/a	EXC501	EXC701

## TRIUMPH

T595 Daytona	97-98	EXC101	EXC901	n/a	EXC501	EXC701
T509 Speed Triple	97-98	EXC101	EXC901	n/a	EXC501	EXC701
Street Triple 675	08>	n/a	n/a	EXCUS30	n/a	n/a
Tiger 800	11>	EXC101	EXC901	n/a	EXC501	EXC701
Tiger 900	>05	EXC101	EXC901	n/a	EXC501	EXC701
Sprint RS	99-04	EXC101	EXC901	n/a	EXC501	EXC701
955i Daytona	98>	EXC101	EXC901	n/a	EXC501	EXC701
Sprint ST 955i	98-04	EXC101	EXC901	n/a	EXC501	EXC701
TT600	00-03	EXC108	EXC908	n/a	EXC508	n/a
1050 Tiger	07>	EXC101	EXC901	n/a	EXC501	EXC701

## YAMAHA

FZR600 R	94-96	EXC101	EXC901	n/a	EXC501	EXC701
FZS600 Fazer	98-04	EXC101	EXC901	n/a	EXC501	EXC701
YZF600 R Thundercat	96-04	EXC101	EXC901	n/a	EXC501	EXC701
XT660R	04>	EXC101	EXC901	n/a	EXC501	EXC701
XT660X	04>	EXC101	EXC901	n/a	EXC501	EXC701
YZF-R6 01MY-02MY	98-02	EXC101	EXC901	n/a	EXC501	EXC701
YZF-R6 03MY-05MY	03-05	EXC101	EXC901	n/a	EXC501	EXC701
YZF750	93-97	EXC101	EXC901	n/a	EXC501	EXC701
FZ8	10>	EXC101	EXC901	n/a	EXC501	EXC701
Fazer 800	10>	EXC101	EXC901	n/a	EXC501	EXC701
TDM900	02>	EXC101	EXC901	n/a	EXC501	EXC701
FZR1000 R (Exup)	89-95	EXC101	EXC901	n/a	EXC501	EXC701
FZS1000 Fazer	00-06	EXC101	EXC901	n/a	EXC501	EXC701
FZ1 N	06>	EXC101	EXC901	n/a	EXC501	EXC701
FZ1 S	06>	EXC101	EXC901	n/a	EXC501	EXC701
YZF-R1 01MY	98-02	EXC101	EXC901	n/a	EXC501	EXC701
YZF-R1 02MY-03MY	02-04	EXC101	EXC901	n/a	EXC501	EXC701
YZF-R1	04-06	n/a	n/a	EXCUS35	n/a	n/a
YZF-R1	07-08	n/a	n/a	EXCUS35	n/a	n/a
YZF-R1	09>	n/a	n/a	EXCUS35	n/a	n/a
XT1200Z Super Tenere	10-12	EXC101	EXC901	n/a	EXC501	EXC701
FJR1300	01>	EXC101	EXC901	n/a	EXC501	EXC701
XJR1200	95-98	EXC101	EXC901	n/a	EXC501	EXC701
XJR1300	99-03	EXC101	EXC901	n/a	EXC501	EXC701
XJR1300	04-06	EXC101	EXC901	n/a	EXC501	EXC701
XJR1300	07>	EXC101	EXC901	n/a	EXC501	EXC701

ALLOY OVAL STUBBY (39CM) WITH CARBON FIBRE END CAP	ALLOY OVAL MICRO (20CM)	ALLOY OVAL MICRO (20CM) WITH CARBON FIBRE END CAP	CAN TYPE	CAN QTY REQUIRED	LINK PIPE
---	----------------------------	--	----------	---------------------	-----------



To order;  
 1> Select bike model  
 2> Choose can type & order  
 correct qty as detailed  
 3> Order link pipe if required

EXC001	EXC601	EXC631	Slip-On	1	CNP421
n/a	n/a	n/a	3 Bolt	1	NOT REQ
n/a	n/a	n/a	4 Bolt	1	NOT REQ
EXC001	EXC601	EXC631	Slip-On	1	CNP416
EXC001	EXC601	EXC631	Slip-On	1	CNP417
EXC001	EXC601	EXC631	Slip-On	1	CNP418
EXC001	EXC601	EXC631	Slip-On	1	CNP425
EXC001	EXC601	EXC631	Slip-On	2	CNP424
n/a	n/a	n/a	4 Bolt	2	NOT REQ
n/a	n/a	n/a	4 Bolt	2	NOT REQ
n/a	n/a	n/a	Slip-On	2	CNP408
n/a	n/a	n/a	3 Bolt	1	NOT REQ
n/a	n/a	n/a	3 Bolt	1	NOT REQ
EXC001	EXC601	EXC631	Slip-On	1	CNP411
EXC001	EXC601	EXC631	Slip-On	1	CNP415
EXC001	EXC601	EXC631	Slip-On	1	CNP419
EXC001	EXC601	EXC631	Slip-On	1	CNP415
n/a	n/a	n/a	Slip-On	1	CNP423
n/a	n/a	n/a	3 Bolt	2	NOT REQ
EXC001	EXC601	EXC631	Slip-On	2	CNP420
EXC001	EXC601	EXC631	Slip-On	2	CNP409
EXC001	EXC601	EXC631	Slip-On	1	CNP412
EXC001	EXC601	EXC631	Slip-On	1	CNP603
EXC001	EXC601	EXC631	Slip-On	1	CNP605
n/a	n/a	n/a	Slip-On	1	CNP609
EXC001	EXC601	EXC631	Slip-On	1	CNP608
EXC001	EXC601	EXC631	Slip-On	1	CNP604
EXC001	EXC601	EXC631	Slip-On	1	CNP601
EXC001	EXC601	EXC631	Slip-On	1	CNP606
EXC001	EXC601	EXC631	Slip-On	1	CNP602
n/a	n/a	n/a	3 Bolt	1	NOT REQ
EXC001	EXC601	EXC631	Slip-On	1	CNP607
EXC001	EXC601	EXC631	Slip-On	1	CNP501
EXC001	EXC601	EXC631	Slip-On	1	CNP502
EXC001	EXC601	EXC631	Slip-On	1	CNP501
EXC001	EXC601	EXC631	Slip-On	2	CNP521
EXC001	EXC601	EXC631	Slip-On	2	CNP521
EXC001	EXC601	EXC631	Slip-On	1	CNP504
EXC001	EXC601	EXC631	Slip-On	1	CNP508
EXC001	EXC601	EXC631	Slip-On	1	CNP514
EXC001	EXC601	EXC631	Slip-On	1	CNP522
EXC001	EXC601	EXC631	Slip-On	1	CNP522
EXC001	EXC601	EXC631	Slip-On	2	CNP515
EXC001	EXC601	EXC631	Slip-On	1	CNP501
EXC001	EXC601	EXC631	Slip-On	1	CNP507
EXC001	EXC601	EXC631	Slip-On	1	CNP512
EXC001	EXC601	EXC631	Slip-On	1	CNP518
EXC001	EXC601	EXC631	Slip-On	1	CNP503
EXC001	EXC601	EXC631	Slip-On	1	CNP505
n/a	n/a	n/a	Slip-On	1	CNP520
n/a	n/a	n/a	Slip-On	2	CNP516
n/a	n/a	n/a	Slip-On	2	CNP517
EXC001	EXC601	EXC631	Slip-On	1	CNP523
EXC001	EXC601	EXC631	Slip-On	2	CNP519
EXC001	EXC601	EXC631	Slip-On	2	CNP509
EXC001	EXC601	EXC631	Slip-On	2	CNP509
EXC001	EXC601	EXC631	Slip-On	2	CNP510
EXC001	EXC601	EXC631	Slip-On	1	CNP511

Viper Race Cans are constructed as a 'straight-through' system, unbaffled for track use. Available in eight shape and material options, including alloy and carbon fibre.

- Motorcyc
- Exhausts
- Screens
- Commuter
- Controls
- Headlights
- Indicators
- Mirrors
- Rear Lights
- Lifts & Stands
- Tools
- Batteries & Chargers
- Electrics
- Chain
- Servicing
- Tyres & Tubes
- Security
- Bike Accs
- Luggage
- Rider Accs
- Tank Pads
- Extras

## Viper E-Marked Cans - with removable baffle

MAKE & MODEL	YEAR	ALLOY ROUND	ALLOY OVAL	CARBON FIBRE OVAL	CARBON FIBRE OVAL WITH CARBON FIBRE END CAP
--------------	------	-------------	------------	-------------------	---



### APRILIA

RSV Mille R	03>	EXC101EM	EXC901EM	n/a	n/a
Tuono 1000	06>	EXC101EM	EXC901EM	n/a	n/a
RSV Mille Factory	04>	EXC101EM	EXC901EM	n/a	n/a
Falco SL1000	00>	EXC101EM	EXC901EM	n/a	n/a
RSV4	10>	EXC101EM	EXC901EM	n/a	n/a
RSV Mille	98-04	EXC101EM	EXC901EM	n/a	n/a
RSV Tuono	98-04	EXC101EM	EXC901EM	n/a	n/a

### BMW

F800 GS	08>	EXC101EM	EXC901EM	EXC501EM	EXC301EM
F800 R	09-12	EXC101EM	EXC901EM	EXC501EM	EXC301EM
R1200 GS Adventure	06-09	EXC101EM	EXC901EM	EXC501EM	EXC301EM
R1200 GS	04-09	EXC101EM	EXC901EM	EXC501EM	EXC301EM
R1200 ST	05>	EXC101EM	EXC901EM	EXC501EM	EXC301EM
R1200 RT	05>	EXC101EM	EXC901EM	EXC501EM	EXC301EM
K1300 S/R/S HP	08-12	EXC101EM	EXC901EM	EXC501EM	EXC301EM

### DUCATI

600 Monster	95-03	EXC101EM	EXC901EM	n/a	n/a
600SS	93-01	EXC101EM	EXC901EM	n/a	n/a
750 Monster	93-03	EXC101EM	EXC901EM	n/a	n/a
750SS	90-98	EXC101EM	EXC901EM	n/a	n/a
900 Monster	93-03	EXC101EM	EXC901EM	n/a	n/a
900SS	93-03	EXC101EM	EXC901EM	n/a	n/a
1000 Monster	04-06	EXC101EM	EXC901EM	n/a	n/a

### HONDA

VFR400 NC21	85-88	EXC101EM	EXC901EM	EXC501EM	EXC301EM
VFR400 NC30	89-93	EXC101EM	EXC901EM	EXC501EM	EXC301EM
CB500	94-03	EXC101EM	EXC901EM	EXC501EM	EXC301EM
CBF500	04-06	EXC101EM	EXC901EM	EXC501EM	EXC301EM
CB600 Hornet	98-02	EXC101EM	EXC901EM	EXC501EM	EXC301EM
CB600F Hornet	03-06	EXC101EM	EXC901EM	EXC501EM	EXC301EM
CB600F Hornet	07-12	EXC101EM	EXC901EM	EXC501EM	EXC301EM
CBF600	04-07	EXC101EM	EXC901EM	EXC501EM	EXC301EM
CBF600	08>	EXC101EM	EXC901EM	EXC501EM	EXC301EM
CBR600 FH-FL	87-90	EXC101EM	EXC901EM	EXC501EM	EXC301EM
CBR600 FM-FR	91-94	EXC101EM	EXC901EM	EXC501EM	EXC301EM
CBR600 FS-FW	94-98	EXC101EM	EXC901EM	EXC501EM	EXC301EM
CBR600 FX FY	99-00	EXC101EM	EXC901EM	EXC501EM	EXC301EM
CBR600 F1	00-01	EXC101EM	EXC901EM	EXC501EM	EXC301EM
CBR600 (with centre stand)	01-05	EXC101EM	EXC901EM	EXC501EM	EXC301EM
CBR600 FS Sport	01-05	EXC101EM	EXC901EM	EXC501EM	EXC301EM
VFR750F R-V	94-97	EXC101EM	EXC901EM	EXC501EM	EXC301EM
VFR800 Fi W-1	97-02	EXC101EM	EXC901EM	EXC501EM	EXC301EM
CB900 Hornet	01>	EXC101EM	EXC901EM	EXC501EM	EXC301EM
CB1000 R	08>	EXC101EM	EXC901EM	EXC501EM	EXC301EM
CBR1000 FH-FX **	87-99	EXC101EM	EXC901EM	EXC501EM	EXC301EM
CBR1000RR	08>	EXC101EM	EXC901EM	EXC501EM	EXC301EM

\*\* Conversion to single can - requires blanking plug - not supplied.



ALLOY OVAL  
WITH CARBON FIBRE  
END CAP

CAN TYPE

CAN QTY  
REQUIRED

LINK PIPE



**NEW**

**VIPER**

To order;  
1> Select bike model  
2> Choose can type & order  
correct qty as detailed  
3> Order link pipe if required

EXC999EM	Slip-On	2	CNP702
EXC999EM	Slip-On	2	CNP702
EXC999EM	Slip-On	2	CNP702
EXC999EM	Slip-On	2	CNP703
EXC999EM	Slip-On	1	CNP704
EXC999EM	Slip-On	1	CNP701
EXC999EM	Slip-On	1	CNP701

EXC999EM	Slip-On	1	CNP801
EXC999EM	Slip-On	1	CNP805
EXC999EM	Slip-On	1	CNP802
EXC999EM	Slip-On	1	CNP802
EXC999EM	Slip-On	1	CNP803
EXC999EM	Slip-On	1	CNP804
EXC999EM	Slip-On	1	CNP806

EXC999EM	Slip-On	2	CNP101
EXC999EM	Slip-On	1	CNP102
EXC999EM	Slip-On	2	CNP101
EXC999EM	Slip-On	2	CNP106
EXC999EM	Slip-On	2	CNP101
EXC999EM	Slip-On	2	CNP105
EXC999EM	Slip-On	2	CNP107

EXC999EM	Slip-On	1	CNP204
EXC999EM	Slip-On	1	CNP206
EXC999EM	Slip-On	1	CNP223
EXC999EM	Slip-On	1	CNP222
EXC999EM	Slip-On	1	CNP201
EXC999EM	Slip-On	1	CNP216
	Slip-On	1	CNP233
EXC999EM	Slip-On	1	CNP221
EXC999EM	Slip-On	1	CNP224
EXC999EM	Slip-On	1	CNP209
EXC999EM	Slip-On	1	CNP202
EXC999EM	Slip-On	1	CNP202
EXC999EM	Slip-On	1	CNP215
EXC999EM	Slip-On	1	CNP213
EXC999EM	Slip-On	1	CNP212
EXC999EM	Slip-On	1	CNP214
EXC999EM	Slip-On	1	CNP207
EXC999EM	Slip-On	1	CNP208
EXC999EM	Slip-On	2	CNP219
EXC999EM	Slip-On	1	CNP225
EXC999EM	Slip-On	1	CNP203
EXC999EM	Slip-On	1	CNP226

Viper E-Marked Cans are constructed with a dB killer making them suitable for road use. Available in five shape and material options, the baffle can be easily removed for track use if required.

- Motorc
- Exhausts
- Screens
- Commuter
- Controls
- Headlights
- Indicators
- Mirrors
- Rear Lights
- Lifts & Stands
- Tools
- Batteries & Chargers
- Electrics
- Chain
- Servicing
- Tyres & Tubes
- Security
- Bike Accs
- Luggage
- Rider Accs
- Tank Pads
- Extras

## Viper E-Marked Cans - with removable baffle

MAKE & MODEL	YEAR	ALLOY ROUND	ALLOY OVAL	CARBON FIBRE OVAL	CARBON FIBRE OVAL WITH CARBON FIBRE END CAP
--------------	------	-------------	------------	-------------------	---



### HONDA cont...

CBF1000	05>	EXC101EM	EXC901EM	EXC501EM	EXC301EM
VTR1000 Firestorm FV-F4	97-05	EXC101EM	EXC901EM	n/a	n/a
VTR1000 SP1	97-02	EXC101EM	EXC901EM	n/a	n/a
VTR1000 SP2	02-03	EXC101EM	EXC901EM	n/a	n/a
CBR1100 XX B/BIRD	96-08	EXC101EM	EXC901EM	EXC501EM	EXC301EM
CB1100 X11	99-02	EXC101EM	EXC901EM	EXC501EM	EXC301EM
CB1300 F/A	03-06	EXC101EM	EXC901EM	EXC501EM	EXC301EM

### KAWASAKI

Ninja 250R (ZX250)	ALL	EXC101EM	EXC901EM	EXC501EM	EXC301EM
ZX-6R Ninja 636 B1H-M1H	03-04	EXC101EM	EXC901EM	EXC501EM	EXC301EM
Z750/S	04-06	EXC101EM	EXC901EM	EXC501EM	EXC301EM
Z750/S	07>	EXC101EM	EXC901EM	EXC501EM	EXC301EM
ZX-9R Ninja B1,2,3,4	94-97	EXC101EM	EXC901EM	EXC501EM	EXC301EM
ZX-9R Ninja E	00-01	EXC101EM	EXC901EM	EXC501EM	EXC301EM
ZX-9R Ninja F	02-05	EXC101EM	EXC901EM	EXC501EM	EXC301EM
ZX-10R Ninja C	04-05	EXC101EM	EXC901EM	EXC501EM	EXC301EM
ZX-10R	10>	EXC101EM	EXC901EM	EXC501EM	EXC301EM
Versys 1000	12>	EXC101EM	EXC901EM	EXC501EM	EXC301EM
Z1000	03-06	EXC101EM	EXC901EM	EXC501EM	EXC301EM
Z1000	07-09	EXC101EM	EXC901EM	EXC501EM	EXC301EM
Z1000 / SX	10>	EXC101EM	EXC901EM	EXC501EM	EXC301EM
ZZR1200	ALL	EXC101EM	EXC901EM	EXC501EM	EXC301EM
GTR1400	07>	EXC101EM	EXC901EM	EXC501EM	EXC301EM
ZZR1400	06-07	EXC101EM	EXC901EM	EXC501EM	EXC301EM
ZZR1400	08-11	EXC101EM	EXC901EM	EXC501EM	EXC301EM
ZZR1400	12	EXC101EM	EXC901EM	EXC501EM	EXC301EM

### KTM

690 Duke	12>	EXC101EM	EXC901EM	EXC501EM	EXC301EM
690 Duke (De-Cat)	12>	EXC101EM	EXC901EM	EXC501EM	EXC301EM

### SUZUKI

GSF600 Bandit	95-99	EXC101EM	EXC901EM	EXC501EM	EXC301EM
GSF600 Bandit	00-06	EXC101EM	EXC901EM	EXC501EM	EXC301EM
GSF650 Bandit	05-06	EXC101EM	EXC901EM	EXC501EM	EXC301EM
GSF650 Bandit	07>	EXC101EM	EXC901EM	EXC501EM	EXC301EM
GSX600F	97-04	EXC101EM	EXC901EM	EXC501EM	EXC301EM
GSX-R600 K8-L0	08-10	EXC101EM	EXC901EM	EXC501EM	EXC301EM
GSX-R600 High Level	06-07	EXC101EM	EXC901EM	EXC501EM	EXC301EM
GSX-R600	11>	EXC101EM	EXC901EM	EXC501EM	EXC301EM
GSX650F	08>	EXC101EM	EXC901EM	EXC501EM	EXC301EM
SV650 /S X-K2 §	99-02	EXC101EM	EXC901EM	EXC501EM	EXC301EM
SV650 /S §	03>	EXC101EM	EXC901EM	EXC501EM	EXC301EM
GSR 750	11>	EXC101EM	EXC901EM	EXC501EM	EXC301EM
GSX750F	97-04	EXC101EM	EXC901EM	EXC501EM	EXC301EM
GSX-R750 High Level	06-07	EXC101EM	EXC901EM	EXC501EM	EXC301EM
GSX-R750	11>	EXC101EM	EXC901EM	EXC501EM	EXC301EM

§ Requires cutting of original link pipe



ALLOY OVAL  
WITH CARBON FIBRE  
END CAP

CAN TYPE

CAN QTY  
REQUIRED

LINK PIPE



**NEW**

**VIPER**

To order;  
1> Select bike model  
2> Choose can type & order  
correct qty as detailed  
3> Order link pipe if required

EXC999EM	Slip-On	2	CNP220
EXC999EM	Slip-On	2	CNP210
EXC999EM	Slip-On	2	CNP217
EXC999EM	Slip-On	2	CNP218
EXC999EM	Slip-On	2	CNP211
EXC999EM	Slip-On	2	CNP211
EXC999EM	Slip-On	1	CNP205
EXC999EM	Slip-On	1	CNP315
EXC999EM	Slip-On	1	CNP305
EXC999EM	Slip-On	1	CNP306
EXC999EM	Slip-On	1	CNP314
EXC999EM	Slip-On	1	CNP301
EXC999EM	Slip-On	1	CNP307
EXC999EM	Slip-On	1	CNP308
EXC999EM	Slip-On	1	CNP309
EXC999EM	Slip-On	1	CNP319
EXC999EM	Slip-On	1	CNP321
EXC999EM	Slip-On	2	CNP310
EXC999EM	Slip-On	2	CNP312
EXC999EM	Slip-On	2	CNP320
EXC999EM	Slip-On	2	CNP316
EXC999EM	Slip-On	1	CNP318
EXC999EM	Slip-On	2	CNP311
EXC999EM	Slip-On	2	CNP317
EXC999EM	Slip-On	2	CNP322
EXC999EM	Slip-On	1	CNP901
EXC999EM	Slip-On	1	CNP902
EXC999EM	Slip-On	1	CNP401
EXC999EM	Slip-On	1	CNP407
EXC999EM	Slip-On	1	CNP407
EXC999EM	Slip-On	1	CNP415
EXC999EM	Slip-On	1	CNP401
EXC999EM	Slip-On	1	CNP414
EXC999EM	Slip-On	1	CNP422
EXC999EM	Slip-On	1	CNP421
EXC999EM	Slip-On	1	CNP415
EXC999EM	Slip-On	1	CNP406
EXC999EM	Slip-On	1	CNP410
EXC999EM	Slip-On	1	CNP426
EXC999EM	Slip-On	1	CNP401
EXC999EM	Slip-On	1	CNP422
EXC999EM	Slip-On	1	CNP421

Viper E-Marked Cans are constructed with a dB killer making them suitable for road use. Available in five shape and material options, the baffle can be easily removed for track use if required.

- Motorcycle
- Exhausts
- Screens
- Commuter
- Controls
- Headlights
- Indicators
- Mirrors
- Rear Lights
- Lifts & Stands
- Tools
- Batteries & Chargers
- Electrics
- Chain
- Servicing
- Tyres & Tubes
- Security
- Bike Accs
- Luggage
- Rider Accs
- Tank Pads
- Extras

## Viper E-Marked Cans - with removable baffle

MAKE & MODEL	YEAR	ALLOY ROUND	ALLOY OVAL	CARBON FIBRE OVAL	CARBON FIBRE OVAL WITH CARBON FIBRE END CAP
--------------	------	-------------	------------	-------------------	---



### SUZUKI cont...

DL1000 VSTROM	02>	EXC101EM	EXC901EM	n/a	n/a
GSX-R1000 K5 K6	05-06	EXC101EM	EXC901EM	EXC501EM	EXC301EM
GSX-R1000 K7 K8	07-08	EXC101EM	EXC901EM	EXC501EM	EXC301EM
GSX-R1000 K9-L1	09-11	EXC101EM	EXC901EM	EXC501EM	EXC301EM
GSX-R1000 L2	12	EXC101EM	EXC901EM	EXC501EM	EXC301EM
GSF1200 Bandit/SA K5-K6	04-06	EXC101EM	EXC901EM	EXC501EM	EXC301EM
GSF1250 Bandit	07>	EXC101EM	EXC901EM	EXC501EM	EXC301EM
GSF1250 Bandit GT	07>	EXC101EM	EXC901EM	EXC501EM	EXC301EM
GSX1250 F	10>	EXC101EM	EXC901EM	EXC501EM	EXC301EM
GSX-R1300 Hayabusa	08>	EXC101EM	EXC901EM	EXC501EM	EXC301EM
GSX1400 K1-K4	01-04	EXC101EM	EXC901EM	EXC501EM	EXC301EM
GSX1400 K5	05>	EXC101EM	EXC901EM	EXC501EM	EXC301EM

### TRIUMPH

T595 Daytona	97-98	EXC101EM	EXC901EM	EXC501EM	EXC301EM
Tiger 800	11>	EXC101EM	EXC901EM	EXC501EM	EXC301EM
T509 Speed Triple	97-98	EXC101EM	EXC901EM	EXC501EM	EXC301EM
Tiger 900	>05	EXC101EM	EXC901EM	EXC501EM	EXC301EM
Sprint RS	99-04	EXC101EM	EXC901EM	EXC501EM	EXC301EM
955i Daytona	98>	EXC101EM	EXC901EM	EXC501EM	EXC301EM
Sprint ST 955i	98-04	EXC101EM	EXC901EM	EXC501EM	EXC301EM
Tiger 1050	07>	EXC101EM	EXC901EM	EXC501EM	EXC301EM

### YAMAHA

FZR600 R	94-96	EXC101EM	EXC901EM	EXC501EM	EXC301EM
FZS600 FAZER	98-04	EXC101EM	EXC901EM	EXC501EM	EXC301EM
YZF600 R Thundercat	96-04	EXC101EM	EXC901EM	EXC501EM	EXC301EM
XT660R	04>	EXC101EM	EXC901EM	EXC501EM	EXC301EM
XT660X	04>	EXC101EM	EXC901EM	EXC501EM	EXC301EM
YZF-R6 01MY-02MY	98-02	EXC101EM	EXC901EM	EXC501EM	EXC301EM
YZF-R6 03MY-05MY	03-05	EXC101EM	EXC901EM	EXC501EM	EXC301EM
YZF750	93-97	EXC101EM	EXC901EM	EXC501EM	EXC301EM
FZ8	10>	EXC101EM	EXC901EM	EXC501EM	EXC301EM
Fazer 800	10>	EXC101EM	EXC901EM	EXC501EM	EXC301EM
TDM900	02>	EXC101EM	EXC901EM	EXC501EM	EXC301EM
FZR1000 R (Exup)	89-95	EXC101EM	EXC901EM	EXC501EM	EXC301EM
FZS1000 Fazer	00-06	EXC101EM	EXC901EM	EXC501EM	EXC301EM
FZ1 N	06>	EXC101EM	EXC901EM	EXC501EM	EXC301EM
FZ1 S	06>	EXC101EM	EXC901EM	EXC501EM	EXC301EM
YZF-R1 01MY	98-02	EXC101EM	EXC901EM	EXC501EM	EXC301EM
YZF-R1 02MY-03MY	02-04	EXC101EM	EXC901EM	EXC501EM	EXC301EM
XJR1200	95-98	EXC101EM	EXC901EM	EXC501EM	EXC301EM
XT1200Z Super Tenere	10-12	EXC101EM	EXC901EM	EXC501EM	EXC301EM
FJR1300	01>	EXC101EM	EXC901EM	EXC501EM	EXC301EM
XJR1300	99-03	EXC101EM	EXC901EM	EXC501EM	EXC301EM
XJR1300	04-06	EXC101EM	EXC901EM	EXC501EM	EXC301EM
XJR1300	07>	EXC101EM	EXC901EM	EXC501EM	EXC301EM

ALLOY OVAL  
WITH CARBON FIBRE  
END CAP

CAN TYPE

CAN QTY  
REQUIRED

LINK PIPE



**NEW**

**VIPER**

To order;  
1> Select bike model  
2> Choose can type & order  
correct qty as detailed  
3> Order link pipe if required

EXC999EM	Slip-On	2	CNP424
EXC999EM	Slip-On	1	CNP416
EXC999EM	Slip-On	1	CNP417
EXC999EM	Slip-On	1	CNP418
EXC999EM	Slip-On	1	CNP425
EXC999EM	Slip-On	1	CNP411
EXC999EM	Slip-On	1	CNP415
EXC999EM	Slip-On	1	CNP419
EXC999EM	Slip-On	1	CNP415
EXC999EM	Slip-On	2	CNP420
EXC999EM	Slip-On	2	CNP409
EXC999EM	Slip-On	1	CNP412

EXC999EM	Slip-On	1	CNP603
EXC999EM	Slip-On	1	CNP608
EXC999EM	Slip-On	1	CNP605
EXC999EM	Slip-On	1	CNP604
EXC999EM	Slip-On	1	CNP601
EXC999EM	Slip-On	1	CNP606
EXC999EM	Slip-On	1	CNP602
EXC999EM	Slip-On	1	CNP607

EXC999EM	Slip-On	1	CNP501
EXC999EM	Slip-On	1	CNP502
EXC999EM	Slip-On	1	CNP501
EXC999EM	Slip-On	2	CNP521
EXC999EM	Slip-On	2	CNP521
EXC999EM	Slip-On	1	CNP504
EXC999EM	Slip-On	1	CNP508
EXC999EM	Slip-On	1	CNP514
EXC999EM	Slip-On	1	CNP522
EXC999EM	Slip-On	1	CNP522
EXC999EM	Slip-On	2	CNP515
EXC999EM	Slip-On	1	CNP501
EXC999EM	Slip-On	1	CNP507
EXC999EM	Slip-On	1	CNP512
EXC999EM	Slip-On	1	CNP518
EXC999EM	Slip-On	1	CNP503
EXC999EM	Slip-On	1	CNP505
EXC999EM	Slip-On	2	CNP509
EXC999EM	Slip-On	1	CNP523
EXC999EM	Slip-On	2	CNP519
EXC999EM	Slip-On	2	CNP509
EXC999EM	Slip-On	2	CNP510
EXC999EM	Slip-On	1	CNP511

Viper E-Marked Cans are constructed with a dB killer making them suitable for road use. Available in five shape and material options, the baffle can be easily removed for track use if required.

- Motorcycle
- Exhausts
- Screens
- Commuter
- Controls
- Headlights
- Indicators
- Mirrors
- Rear Lights
- Lifts & Stands
- Tools
- Batteries & Chargers
- Electrics
- Chain
- Servicing
- Tyres & Tubes
- Security
- Bike Accs
- Luggage
- Rider Accs
- Tank Pads
- Extras



MotoGP  
 Exhausts  
 Screens  
 Commuter  
 Controls  
 Headlights  
 Indicators  
 Mirrors  
 Rear Lights  
 Lifts & Stands  
 Tools  
 Batteries & Chargers  
 Electrics  
 Chain  
 Servicing  
 Tyres & Tubes  
 Security  
 Bike Accs  
 Luggage  
 Rider Accs  
 Tank Pads  
 Extras  
 www.bikeit.co.uk

## Exhaust Inlet Reducer Kit

Inlet reducer kits consist of inter-changeable sleeves to allow exhaust fitment to narrower pipes.

Order Code	Description
<b>EXCRDC04</b>	4pc sleeves, 38mm/41mm/44.5mm/47.5mm (minimum closure 36mm)
<b>EXCRDC08</b>	3pc sleeves, 46mm/49mm/52mm (minimum closure 44mm)



## Exhaust Gaskets

Avoid sales of illegal and harmful asbestos type with our asbestos free formula. Pack of 10.

Order Code	Outer Diameter	Order Code	Outer Diameter
<b>EXG26</b>	26mm	<b>EXG44</b>	44mm
<b>EXG28</b>	28mm	<b>EXG45</b>	45mm
<b>EXG30</b>	30mm	<b>EXG46</b>	46mm
<b>EXG33</b>	33mm	<b>EXG47</b>	47mm
<b>EXG35</b>	35mm	<b>EXG48</b>	48mm
<b>EXG36</b>	36mm	<b>EXG49</b>	49mm
<b>EXG38</b>	38mm	<b>EXG51</b>	51mm
<b>EXG39</b>	39mm	<b>EXG53</b>	53mm
<b>EXG40</b>	40mm	<b>EXG54</b>	54mm
<b>EXG41</b>	41mm	<b>EXG55</b>	55mm
<b>EXG42</b>	42mm	<b>EXG56</b>	56mm
<b>EXG43</b>	43mm	<b>EXG62</b>	62mm



## Replacement Silencers

OEM equivalent replacement silencers at a fraction of the cost.

Order Code	Model
<b>HONDA</b>	
<b>EXHVIS</b>	VISION
<b>EXHC90CUB</b>	C90 CUB
<b>EXHANF125</b>	ANF125 Innova



## Ladder Display Stand

This purpose designed stand is perfect for displaying up to 6 Viper race cans and accessories.

Manufactured from lightweight aluminium, each ladder stand includes 6 exhaust hangers which can be attached 3 on each side of the unit. If less cans are required for display, remove the exhaust hangers and replace with eurohooks (included) to display a multitude of other product.

A double-sided perspex header section allows A4 size graphics to be easily inserted for optimum POS presentation, whilst a weighted base section keeps the unit stable and secure.

Order Code: **POSLAD01**



## Exhaust Mounting

Universal mounting brackets provide additional support for exhausts without integral hangers. Available in 2 1/2" and 2 7/8" pipe diameter fitment

Order Code	Description
<b>EXUST02</b>	2 1/2" pipe fitment, central hanger
<b>EXUST04</b>	2 7/8" pipe fitment, offset angled hanger



## Universal Silencers

A comprehensive range of universal road silencers in traditional and custom styles. Each silencer is finished to a superb high chrome quality, details of baffle and bracket configurations listed individually below. Some models are supplied with inlet reducer kits allowing a range of inlet diameters as detailed. Inlet reducer kits are also available to buy separately, see opposite page.

**EXUCON19** - 19" cone  
Length - 48cm / 19"  
Inlet OD - Min 38mm / Max 45mm  
Fixed Baffle  
Mounting Hangar



**EXUCLU16** - 16" Club  
Length - 40cm / 16"  
Inlet ID - 45mm  
No Baffle  
Slide Bracket



**EXUFIN20** - 20" Tailfin  
Length - 50cm / 20"  
Inlet ID - 45mm  
Fixed Baffle



**EXUBEV12** - 12" Bevel Shorty  
Length - 30cm / 12"  
Inlet ID - Min 38mm / Max 45mm  
Removable Baffle  
Slide Bracket

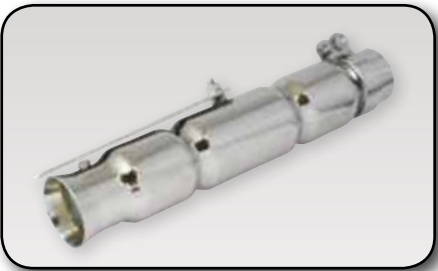

**EXUFIS30** - 30" Fish Tail  
Length - 76cm / 30"  
Inlet ID - 45mm  
Fixed Baffle  
Without Bracket



**EXUFIS22** - 22" Fish Tail  
Length - 56cm / 22"  
Inlet ID - Min 38mm / Max 45mm  
Fixed Baffle  
Without Bracket



**EXUBEV15** - 15" Bevel Slash cut  
Length - 38cm / 15"  
Inlet OD - Min 38mm / Max 45mm  
Slide Bracket  
Removable Baffle



**EXUCONE** - 20" Chrome cone  
Length - 50cm / 20"  
Inlet OD - Min 36mm / Max 45mm



**EXUSL15** - 15" Slash cut  
Length - 37.5cm / 15"  
Inlet OD - Min 36mm / Max 45mm



**EXUMEGA** - Megaphone (R/L)  
Length - 57.5cm / 23"  
Inlet OD - Min 38mm / Max 45mm



**EXUTURN** - 19" Turnout  
Length - 47.5cm / 19"  
Inlet OD - Min 36mm / Max 45mm



**EXUSHORT** - shorty with mounting (R/L)  
Length - 30cm / 12"  
Inlet OD - Min 38mm / Max 45mm



**EXUTAP15** - 15" Tapered with mounting  
Length - 37.5cm / 15"  
Inlet OD - Min 36mm / Max 45mm



**EXUSL24** - 24" Slash cut  
Length - 60cm / 24"  
Inlet OD - Min 36mm / Max 45mm



Motorcycle  
Exhausts  
Screens  
Commuter  
Controls  
Headlights  
Indicators  
Mirrors  
Rear Lights  
Lifts & Stands  
Tools  
Batteries & Chargers  
Electrics  
Chain  
Servicing  
Tyres & Tubes  
Security  
Bike Accs  
Luggage  
Rider Accs  
Tank Pads  
Extras

## Viper Scooter Silencers

Viper's range of reverse sports silencers are available for most of today's scooters. Homologated for road use, the reversed and downward end can is designed to improve power and speed over the original manufacturer's silencer.

It must be noted that the consequential increase in speed and power may render the scooter too powerful for the legal limit set for learner riders.

All silencers are available in a choice of 2

body finishes, "original smoked varnish" and "high chrome". Both types feature stylish black end cans with the VIPER logo.



VIP040CH



VIP379CH



VIP375CH



VIP380



VIP242

MODEL	SMOKED SILENCER	CHROME SILENCER	CLUTCH ROLLERS
-------	-----------------	-----------------	----------------

### ALUNIX

Alunix 50	VIP375	VIP375CH	VIPROLA
-----------	--------	----------	---------

### APRILIA

SR 01-03 Franco Morini*	VIP379	VIP379CH	VIPROLD
SR 04> Piaggio engine*	VIP040	VIP040CH	VIPROLB
Scarabeo	VIP375	VIP375CH	VIPROLA
Scarabeo Morini	VIP379	VIP379CH	VIPROLD
SR 50 >94 Minarelli Horiz	VIP375	VIP375CH	VIPROLA
SR '00 Morini	VIP379	VIP379CH	VIPROLD
Rally	VIP375	VIP375CH	VIPROLA
Company Custom (Piaggio engine)	VIP040	VIP040CH	VIPROLB
Sportcity One 2T	VIP040	VIP040CH	VIPROLB
SR Factory	VIP040	VIP040CH	VIPROLB
Sonic	VIP375	VIP375CH	VIPROLA
Area 51	VIP375	VIP375CH	VIPROLA
Gulliver	VIP375	VIP375CH	VIPROLA

### BENELLI

491 Strada	VIP375	VIP375CH	VIPROLA
Namur	VIP375	VIP375CH	VIPROLA
491 RR 50 (Minarelli engine)	VIP375	VIP375CH	VIPROLA
K2 50	VIP375	VIP375CH	VIPROLA
Pepe	VIP375	VIP375CH	VIPROLA
Pepe LX	VIP375	VIP375CH	VIPROLA
Quattro Nove X	VIP375	VIP375CH	VIPROLA

### BETA

Chrono/Ch 502	VIP375	VIP375CH	VIPROLA
Tempo 13-16	VIP375	VIP375CH	VIPROLA
Quadra	VIP375	VIP375CH	VIPROLA
ARK	VIP375	VIP375CH	VIPROLA
Eikon 50	VIP375	VIP375CH	VIPROLA

### DERBI

GP1 <05	VIP040	VIP040CH	VIPROLB
Atlantis (Piaggio engine)	VIP040	VIP040CH	VIPROLB
Easy	VIP375	VIP375CH	VIPROLA
GP1 50 Open	VIP040	VIP040CH	VIPROLB
Sonar 50	VIP040	VIP040CH	VIPROLB
Variant Sport 50	VIP040	VIP040CH	VIPROLB
Boulevard 50	VIP040	VIP040CH	VIPROLB

MODEL	SMOKED SILENCER	CHROME SILENCER	CLUTCH ROLLERS
-------	-----------------	-----------------	----------------

### E-ton

Beamer	VIP380		VIPROLA
Beamer III	VIP380		VIPROLA
Sport 50	VIP380		VIPROLA
Matrix 50	VIP380		VIPROLA

### GENUINE

Buddy 50	VIP375	VIP375CH	VIPROLA
Roughhouse R50	VIP375	VIP375CH	VIPROLA

### GILERA

DNA	VIP040	VIP040CH	VIPROLC
Easy Moving	VIP040	VIP040CH	VIPROLB
Typhoon 50	VIP040	VIP040CH	VIPROLB
Runner 50	VIP040	VIP040CH	VIPROLB
Ice	VIP040	VIP040CH	VIPROLB
Stalker	VIP040	VIP040CH	VIPROLB

### ITALJET

Formula 50Minarelli	VIP375	VIP375CH	VIPROLA
Jet Set 50	VIP040	VIP040CH	VIPROLB
Torpedo 50 (Piaggio engine)	VIP040	VIP040CH	VIPROLB
Dragster 50	VIP375	VIP375CH	VIPROLA
Formula 50 (Minarelli Horiz)	VIP375	VIP375CH	VIPROLA

### MALAGUTI

F10 Jetline 50	VIP375	VIP375CH	VIPROLA
F12 Phantom 50	VIP375	VIP375CH	VIPROLA
F15 Firefox 50	VIP375	VIP375CH	VIPROLA
Ciak 50	VIP375	VIP375CH	VIPROLA
Yesterday 50	VIP375	VIP375CH	VIPROLA

### MBK

Evolis 50-80	VIP375	VIP375CH	VIPROLA
Flipper 50	VIP375	VIP375CH	VIPROLA
Forte	VIP375	VIP375CH	VIPROLA
Fizz	VIP375	VIP375CH	VIPROLA
Ovetto 50	VIP375	VIP375CH	VIPROLA
Nitro	VIP375	VIP375CH	VIPROLA
Nitro 50	VIP375	VIP375CH	VIPROLA
Nitro/ Ovetto 100cc	VIP380		VIPROLA
MachG	VIP375	VIP375CH	VIPROLA
Match	VIP375	VIP375CH	VIPROLA
Stunt	VIP375	VIP375CH	VIPROLA

\* Not 94-00 Minarelli engine



## Viper Scooter Silencers cont...

MODEL	SMOKED SILENCER	CHROME SILENCER	CLUTCH ROLLERS
<b>MZ</b>			
Moskito RX 50	VIP375	VIP375CH	VIPROLA
<b>PIAGGIO</b>			
Typhoon 50	VIP040	VIP040CH	VIPROLC
C22 (NRG50)	VIP040	VIP040CH	VIPROLE
Liberty 50	VIP040	VIP040CH	VIPROLC
NRG/mc2/mc3	VIP040	VIP040CH	VIPROLC
NTT	VIP040	VIP040CH	VIPROLC
Extreme	VIP040	VIP040CH	VIPROLC
Storm	VIP040	VIP040CH	VIPROLC
Free	VIP040	VIP040CH	VIPROLC
Zip 50 2T	VIP040	VIP040CH	VIPROLC
Zip Fast Rider	VIP040	VIP040CH	VIPROLE
Zip 25km/h	VIP040	VIP040CH	VIPROLE
Diesis 50	VIP040	VIP040CH	VIPROLC
Fly 50 2T	VIP040	VIP040CH	VIPROLC
Quartz	VIP040	VIP040CH	VIPROLC
TPH50	VIP040	VIP040CH	VIPROLC

MODEL	SMOKED SILENCER	CHROME SILENCER	CLUTCH ROLLERS
<b>PUCH</b>			
Stalker	VIP040	VIP040CH	VIPROLB

MODEL	SMOKED SILENCER	CHROME SILENCER	CLUTCH ROLLERS
<b>PEUGEOT</b>			
Buxy >98	VIP242	VIP242CH	VIPROLB
Zenith >98	VIP242	VIP242CH	VIPROLB
Squab 50	VIP242	VIP242CH	VIPROLB
Speedfight 1/ 2 50	VIP242	VIP242CH	VIPROLB
Vivacity 50	VIP242	VIP242CH	VIPROLB
Trekker 50	VIP242	VIP242CH	VIPROLB
Elyseo 50	VIP242	VIP242CH	VIPROLB
Looxor 50	VIP242	VIP242CH	VIPROLB
Elystar 50	VIP242	VIP242CH	n/a
TKR	VIP242	VIP242CH	n/a

MODEL	SMOKED SILENCER	CHROME SILENCER	CLUTCH ROLLERS
<b>RIEJU</b>			
First	VIP375	VIP375CH	VIPROLA
Windy 50	VIP375	VIP375CH	VIPROLA
F-10 50	VIP375	VIP375CH	VIPROLA

MODEL	SMOKED SILENCER	CHROME SILENCER	CLUTCH ROLLERS
<b>SIAMOTO</b>			
Top racing 50	VIP375	VIP375CH	VIPROLA
Birdie	VIP375	VIP375CH	VIPROLA
Mat 50	VIP375	VIP375CH	VIPROLA

MODEL	SMOKED SILENCER	CHROME SILENCER	CLUTCH ROLLERS
<b>SMC</b>			
NDF / NMF / NGF / SAF 50cc 95>	VIP375	VIP375CH	VIPROLA

MODEL	SMOKED SILENCER	CHROME SILENCER	CLUTCH ROLLERS
<b>SUZUKI</b>			
Katana AY50	VIP379	VIP379CH	VIPROLD
Zillion 50	VIP379	VIP379CH	VIPROLD
Estilete	VIP379	VIP379CH	VIPROLD

MODEL	SMOKED SILENCER	CHROME SILENCER	CLUTCH ROLLERS
<b>TNG</b>			
LS	VIP375	VIP375CH	VIPROLA
SS	VIP375	VIP375CH	VIPROLA
Venice	VIP375	VIP375CH	VIPROLA

MODEL	SMOKED SILENCER	CHROME SILENCER	CLUTCH ROLLERS
<b>VENTO</b>			
Triton GT5	VIP375	VIP375CH	VIPROLA
Triton LI 2T	VIP375	VIP375CH	VIPROLA
Triton r4	VIP375	VIP375CH	VIPROLA
Zip R3i	VIP375	VIP375CH	VIPROLA

MODEL	SMOKED SILENCER	CHROME SILENCER	CLUTCH ROLLERS
<b>YAMAHA</b>			
Jog	VIP375	VIP375CH	VIPROLA
Axis 50	VIP375	VIP375CH	VIPROLA
Jog RR	VIP375	VIP375CH	VIPROLA
Breeze	VIP375	VIP375CH	VIPROLA
Zest 50-90	VIP375	VIP375CH	VIPROLA
Neo's 50	VIP375	VIP375CH	VIPROLA
Aerox	VIP375	VIP375CH	VIPROLA
Neo's 100	VIP380		VIPROLA
BW's 100	VIP380		VIPROLA
Aerox 100	VIP380		VIPROLA
Vino	VIP375	VIP375CH	VIPROLA
Why	VIP375	VIP375CH	VIPROLA
Zuma	VIP375	VIP375CH	VIPROLA
Bw's Next Generation	VIP380		VIPROLA
Jog 90	VIP380		VIPROLA

## Clutch Rollers

### DON'T FORGET TO ORDER CLUTCH ROLLERS!

Viper Scooter Silencers are supplied WITHOUT clutch rollers. It is recommended that new rollers are fitted at the same time as the Viper exhaust silencer being fitted. Full details of the clutch roller range is detailed below, check the application chart on this page for the correct rollers to use for each scooter model.

NB: The rollers compatibility detailed here is based on the scooter's rider weighing 75kgs / 12 stone or less.

Order Code	Specification
VIPROLA	15x12 4.75g
VIPROLB	16x13 6.5g
VIPROLC	19x15 4.5g
VIPROLD	17x12 5.5g
VIPROLE	19x15.5 4.5g

6 pieces per pack



## Silencer Gaskets

Bespoke replacement exhaust gaskets for Viper scooter silencers. Model fitment as shown below.

Order Code	Fits
VIPGSKA	VIP375, VIP040, VIP379, VIP380
VIPGSKB	VIP242



Motorcycle  
Exhausts  
Screens  
Commuter  
Controls  
Headlights  
Indicators  
Mirrors  
Rear Lights  
Lifts & Stands  
Tools  
Batteries & Chargers  
Electrics  
Chain  
Servicing  
Tyres & Tubes  
Security  
Bike Accs  
Luggage  
Rider Accs  
Tank Pads  
Extras





# Airblade™

## RACING SCREENS

### ADDED PROTECTION WITH STYLE

Airblade double bubble racing screens add style to sports bikes whilst increasing performance and ride ability with the drag reducing design. Sports screens are available in Dark Smoke, Light Smoke, Clear, Blue and the exclusive Iridium colour finish. There is also a range of custom and fly screens in Smoked, Clear & Iridium finish, all complete with easy install fitting kit.

CLEAR

LIGHT  
SMOKED

IRIDIUM

**BSB**  
BRITISH SUPERBIKES

Airblade Racing Screens,  
original equipment to  
British Superbike Teams.

DARK  
SMOKED

BLUE

[WWW.AIRBLADERACING.COM](http://WWW.AIRBLADERACING.COM)

BIKE	YEAR	CLEAR	LIGHT SMOKED	BLUE	DARK SMOKED	IRIDIUM
<b>APRILIA</b>						
RS50	98-05	SCRA008	SCRA009	#	SCRA006	SCRA007
RS125	97-05	SCRA008	SCRA009	#	SCRA006	SCRA007
RS250	98-03	SCRA008	SCRA009	#	SCRA006	SCRA007
RSV1000 Tuono	03-05	#	SCRA010	#	SCRA005	SCRA004
Tuono	06-10	#	SCRA016	#	SCRA014	SCRA015
RSV1000 Mille	98-00	SCRA019	SCRA020	#	SCRA017	SCRA018
RSV1000 Mille*	01-03	SCRA012	SCRA011	#	SCRA001	#
RSV1000R	04-08	SCRA023	SCRA024	#	SCRA021	SCRA022
RSV Factory	04-08	SCRA023	SCRA024	#	SCRA021	SCRA022
<b>BMW</b>						
F800 S / ST	06-12	SCRB001	SCRB002	#	SCRB003	#
R1100S	98-05	SCRB004	SCRB005	#	SCRB006	#
S1000 RR	10-12	SCRB007	SCRB008	#	SCRB009	#
K1200 S	04-08	SCRB010	SCRB011	#	SCRB012	#
K1300 S	09-12	SCRB010	SCRB011	#	SCRB012	#
<b>DUCATI</b>						
620 Sport (fuel inj) *	03-04	#	SCRD021	#	SCRD019	SCRD020
748	94-02	SCRD003	SCRD008	#	SCRD001	#
749 (with cut out)	03-05	SCRD007	SCRD009	#	SCRD005	SCRD006
749 (no cut out)	03-05	SCRD012	SCRD014	#	SCRD010	SCRD011
750 SSI *	98-06	#	SCRD021	#	SCRD019	SCRD020
800 SSI *	03-06	#	SCRD021	#	SCRD019	SCRD020
800 Sport (fuel inj) *	03>	#	SCRD021	#	SCRD019	SCRD020
848	07>	SCRD017	SCRD018	#	SCRD015	SCRD016
900 SS *	98-02	#	SCRD021	#	SCRD019	SCRD020
916	93-01	SCRD003	SCRD008	#	SCRD001	#
996 / R		SCRD003	SCRD008	#	SCRD001	#
998		SCRD003	SCRD008	#	SCRD001	#
999 (with cut out)	03-05	SCRD007	SCRD009	#	SCRD005	SCRD006
999 (no cut out)	03-05	SCRD012	SCRD014	#	SCRD010	SCRD011
1000 SSI *	03-06	#	SCRD021	#	SCRD019	SCRD020
1098	07>	SCRD017	SCRD018	#	SCRD015	SCRD016
1198	09>	SCRD017	SCRD018	#	SCRD015	SCRD016
1199 Panigale	12>	SCRD022	SCRD023	#	SCRD024	#
<b>HONDA</b>						
CBR125R	04-06	SCRH081	SCRH079	#	SCRH080	SCRH082
CBR125R	07-10	SCRH100	SCRH101	#	SCRH102	#
CBR125R	11-12	SCRH117	SCRH118	#	SCRH119	#
NC29 Gull	90-94	SCRH115	SCRH116	#	#	#
NC23 Tri		SCRH112	SCRH114	#	#	#
CBR250R	11-12	SCRH120	SCRH121	#	SCRH122	#
VFR400 NC30		SCRH087	SCRH084	#	SCRH085	SCRH086
VFR400 NC30 (STANDARD)*		SCRH091	SCRH088	#	SCRH089	SCRH090
RVF400 NC35		SCRH058	#	#	SCRH083	#
CB600S Hornet	99-03	SCRH104	SCRH105	#	SCRH106	SCRH107
CBR600 FS,FT,FV,FW	95-98	SCRH036	SCRH063	#	SCRH001	SCRH011
CBR600 FX,FY	99-00	SCRH032	SCRH064	#	SCRH002	SCRH012
CBR600 F1-F10	01-10	SCRH037	SCRH065	#	SCRH024	SCRH022
CBR600 FA ABS	11-12	SCRH027	SCRH028	#	SCRH029	#
CBR600 FS1-2 Sport	01-02	SCRH037	SCRH065	#	SCRH024	SCRH022
CBR600RR	03-04	SCRH041	SCRH066	#	SCRH039	SCRH040
CBR600RR	05-06	SCRH061	SCRH067	#	SCRH059	SCRH060
CBR600RR	07-12	SCRH098	SCRH099	#	SCRH096	SCRH097
VFR750F R-V	94-97	#	SCRH068	#	SCRH003	#
VFR800 VFR F1-1	98-01	#	SCRH069	#	SCRH004	#
VFR800 V-TEC	02-12	#	SCRH070	#	SCRH042	SCRH043
CBR900RR R/S/TV	94-97	SCRH033	SCRH071	#	SCRH005	SCRH020
CBR900RR W/X	98-99	SCRH034	SCRH072	#	SCRH006	SCRH016
CBR900RR Y/1	00-01	SCRH035	SCRH073	#	SCRH007	SCRH017
CBR900RR 2/3	02-03	SCRH038	SCRH074	#	SCRH025	SCRH026
CBR1000RR	04-07	SCRH057	SCRH075	#	SCRH056	SCRH055

\* Standard screen

Motorcycle  
Exhausts  
Scooter  
Commuter  
Controls  
Headlights  
Indicators  
Mirrors  
Rear Lights  
Lifts & Stands  
Tools  
Batteries & Chargers  
Electrics  
Chain  
Servicing  
Tyres & Tubes  
Security  
Bike Accs  
Luggage  
Rider Accs  
Tank Pads  
Extras  
www.bikeit.co.uk



# Airblade Racing Screens cont...

BIKE	YEAR	CLEAR	LIGHT SMOKED	BLUE	DARK SMOKED	IRIDIUM
<b>HONDA Cont...</b>						
CBR1000RR	08-11	SCRH094	SCRH095	#	SCRH092	SCRH093
CBR1000RR	12>	SCRH123	SCRH124	#	SCRH125	#
VTR1000 Firestorm FV-F5	97-05	#	SCRH076	#	SCRH008	SCRH018
VTR1000SP Y1/1/2/5	00-05	#	SCRH077	#	SCRH009	SCRH019
CBR1100XX	97-05	#	SCRH078	#	SCRH010	SCRH021
CB1300S	06>	SCRH108	SCRH109	#	SCRH110	#
<b>KAWASAKI</b>						
EX 250 Ninja / Ninja 250 R*	88-06	SCRK069	SCRK070	#	SCRK067	SCRK068
Ninja 250R	08-12	SCRK090	SCRK091	#	SCRK092	#
ZXR400 L1-L9	91-03	SCRK042	#	#	#	#
ER-6F	06-08	#	SCRK066	#	SCRK064	SCRK065
ER-6F	09-11	SCRK033	SCRK034	#	SCRK036	#
ER-6F	12>	SCRK071	SCRK072	#	SCRK073	#
ZX6R Ninja F1-3	95-97	#	SCRK047	#	SCRK001	#
ZX6R Ninja G1-2	98-99	#	SCRK048	#	SCRK002	SCRK012
ZX6R Ninja J1-2, 636 A1P	00-02	SCRK023	SCRK049	#	SCRK003	SCRK013
ZX6R Ninja 636 B1H-B2H, K1H, M1H	03-04	SCRK029	SCRK050	#	SCRK027	SCRK028
ZX6-R Ninja 636 C1H-P8F	05-08	SCRK045	SCRK046	#	SCRK043	SCRK044
ZX6-R Ninja P9F - RBF	09-12	SCRK079	SCRK080	#	SCRK077	SCRK078
ZZR600 E1-E7F	93>	#	SCRK051	#	SCRK004	SCRK035
ZX7R P1-7, RR	96-03	#	SCRK052	#	SCRK005	#
Z750S	05-07	#	SCRK083	#	SCRK084	SCRK085
ZX9R Ninja B1-B4	94-97	SCRK030	SCRK031	#	SCRK032	#
ZX9R Ninja C1-C2	98-99	#	SCRK053	#	SCRK006	SCRK016
ZX9R Ninja E1-E2 F1P-F2P	00-03	SCRK024	SCRK054	#	SCRK007	SCRK017
ZX10R Ninja C1H-C2H	04-05	SCRK041	SCRK055	#	SCRK040	SCRK039
ZX10R Ninja D6F	06-07	SCRK045	SCRK046	#	SCRK043	SCRK044
ZX10R Ninja E8F-FAF	08-10	SCRK086	SCRK087	#	SCRK088	SCRK089
ZX10R Ninja	11-12	SCRK021	SCRK022	#	SCRK037	#
Z1000	03-06	#	#	#	SCRK075	SCRK076
Z1000	10-12	SCRK038	SCRK062	#	SCRK063	#
Z1000 SX	11-12	SCRK074	SCRK093	#	SCRK094	#
ZZR1100 D1-D9	93-02	#	SCRK056	#	SCRK008	#
ZX12R A1-A2	00-01	#	SCRK057	#	SCRK009	SCRK019
ZX12R B1H-B6F	02-06	#	SCRK058	#	SCRK010	SCRK020
ZZR1200 C1H-C2H	02-05	#	SCRK059	#	SCRK025	#
ZZR1400 / ZX-14	06-12	#	#	#	SCRK081	SCRK082
<b>MV AGUSTA</b>						
MV Agusta F4*	03-09	#	SCRM002	#	SCRM001	#
<b>SUZUKI</b>						
GSF600S Bandit	00-07	#	SCRS061	#	SCRS059	SCRS060
GSF650 S Bandit	05-08	#	SCRS058	#	SCRS056	SCRS057
GSX600 FW> Katana*	97-04	SCRS065	SCRS066	#	SCRS063	SCRS064
GSX-R600 W V-Y	96-00	SCRS020	SCRS046	#	SCRS002	SCRS012
GSX-R600 K1-K3	01-03	SCRS019	SCRS047	#	SCRS007	SCRS017
GSX-R600 K4-K5	04-05	SCRS039	SCRS048	#	SCRS037	SCRS038
GSX-R600 K6-K7	06-07	SCRS069	SCRS071	#	SCRS067	SCRS068
GSX-R600 K8-L0	08-10	SCRS081	SCRS082	SCRS083	SCRS084	SCRS085
GSX-R600 L1-L2	11-12	SCRS003	SCRS008	#	SCRS009	#
GSX650F	08-12	SCRS094	SCRS095	#	SCRS096	#
SV650S X-K2*	99-02	#	SCRS049	#	SCRS001	SCRS011
SV650S K3-L2*	03-12	#	SCRS050	#	SCRS035	SCRS036
GSX750 FW> Katana*	97-04	SCRS065	SCRS066	#	SCRS063	SCRS064
GSX-R750 WT-WX	96-99	SCRS020	SCRS046	#	SCRS002	SCRS012
GSX-R750 WY K3	00-03	SCRS019	SCRS047	#	SCRS007	SCRS017
GSX-R750 K4-K5	04-05	SCRS039	SCRS048	#	SCRS037	SCRS038
GSX-R750 K6-K7	06-07	SCRS069	SCRS071	#	SCRS067	SCRS068
GSX-R750 K8	08-10	SCRS081	SCRS082	SCRS083	SCRS084	SCRS085
GSX-R750 L1-L2	11-12	SCRS003	SCRS008	#	SCRS009	#
GSX-R1000 K1-K2	01-02	SCRS019	SCRS047	#	SCRS007	SCRS017

\* Standard screen

MotoGP  
Exhausts  
Screens  
Commuter  
Controls  
Headlights  
Indicators  
Mirrors  
Rear Lights  
Lifts & Stands  
Tools  
Batteries & Chargers  
Electrics  
Chain  
Servicing  
Tyres & Tubes  
Security  
Bike Accs  
Luggage  
Rider Accs  
Tank Pads  
Extras  
www.bikeit.co.uk

## Airblade Racing Screens cont...

BIKE	YEAR	CLEAR	LIGHT SMOKED	BLUE	DARK SMOKED	IRIDIUM
<b>SUZUKI Cont...</b>						
GSX-R1000 K3-K4	03-04	SCRS032	SCRS051	SCRS033	SCRS030	SCRS031
GSX-R1000 K5-K6	05-06	SCRS043	SCRS055	SCRS044	SCRS041	SCRS042
GSX-R1000 K7-K8	07-08	SCRS078	SCRS080	#	SCRS076	SCRS077
GSX-R1000 K9-L2	09-12	SCRS089	SCRS090	SCRS093	SCRS091	SCRS092
SV1000S*	03-05	#	SCRS050	#	SCRS035	SCRS036
TL1000S V-Y	97-01	#	SCRS052	#	SCRS004	SCRS014
TL1000R W-K1	98-04	#	SCRS053	#	SCRS005	SCRS015
GSF1200 S Bandit	00-05	#	SCRS061	#	SCRS059	SCRS060
GSF1200 S Bandit	06-07	#	SCRS058	#	SCRS056	SCRS057
GSF1250 S Bandit	07-11	#	SCRS058	#	SCRS056	SCRS057
GSX1250 FA / FT	10-12	SCRS094	SCRS095	#	SCRS096	#
GSX1300R Hayabusa RX-K7	99-07	#	SCRS054	#	SCRS006	SCRS016
GSX1300R Hayabusa K8-L2	08-12	#	SCRS086	#	SCRS087	SCRS088
<b>TRIUMPH</b>						
Daytona 600	03-05	#	SCRT005	#	SCRT014	#
Daytona 650	05-06	#	SCRT005	#	SCRT014	#
Daytona 675	06-08	SCRT024	SCRT025	#	SCRT026	SCRT027
Daytona 675	09-12	SCRT028	SCRT029	#	SCRT030	#
Daytona 675R	11-12	SCRT028	SCRT029	#	SCRT030	#
T595	97-00	#	SCRT004	#	SCRT001	SCRT011
T595i	97-00	#	SCRT004	#	SCRT001	SCRT011
T955i Daytona	97-00	#	SCRT004	#	SCRT001	SCRT011
T955fi Daytona	01-03	#	SCRT006	#	SCRT002	SCRT003
T955i Daytona	04-06	SCRT008	SCRT009	#	SCRT007	#
Sprint ST	98-04	#	SCRT017	#	SCRT015	SCRT016
Sprint ST (2 holes)	05-10	#	SCRT020	#	SCRT018	SCRT019
Sprint RS	00-03	#	SCRT023	#	SCRT021	SCRT022
Sprint GT 1050	10-12	#	#	#	SCRT033	#
Sprint ST	11>	#	#	#	SCRT033	#
<b>YAMAHA</b>						
YZF-R125	08-12	SCRY092	SCRY093	SCRY094	SCRY095	SCRY096
FZR400 3TJ RRSF		SCRY051	#	#	#	#
T-Max 500	00-07	#	SCRY097	#	SCRY098	SCRY099
FZS600 Fazer	98-01	#	SCRY053	#	SCRY001	SCRY011
FZS600 Fazer *	02-03	#	SCRY054	#	SCRY019	SCRY020
FZ-6 Fazer S2	07-09	SCRY075	SCRY076	#	SCRY073	SCRY074
XJ6 Diversion	09-12	SCRY021	SCRY022	#	SCRY023	#
XJ6F Diversion	10-12	SCRY035	SCRY036	#	SCRY037	#
YZF600 Thundercat	96-04	#	SCRY055	#	SCRY002	SCRY012
YZF-R6	98-02	SCRY024	SCRY056	SCRY007	SCRY003	SCRY013
YZF-R6	03-05	SCRY034	SCRY057	SCRY049	SCRY032	SCRY033
YZF-R6	06-07	SCRY066	SCRY067	#	#	SCRY065
YZF-R6	08-12	SCRY082	SCRY083	SCRY084	SCRY085	SCRY086
TDM900	02-05	#	#	#	SCRY030	SCRY031
FZS1000 Fazer *	01-05	#	SCRY058	#	SCRY028	SCRY029
FZ-1S *	06-12	SCRY080	SCRY081		SCRY078	SCRY079
YZF1000 Thunderace	96-03	#	SCRY059	#	SCRY004	#
YZF-R1	98-99	SCRY025	SCRY060	SCRY008	SCRY005	SCRY015
YZF-R1	00-01	SCRY026	SCRY061	SCRY009	SCRY006	SCRY016
YZF-R1	02-03	SCRY027	SCRY062	SCRY050	SCRY018	SCRY017
YZF-R1	04-06	SCRY047	SCRY063	SCRY048	SCRY045	SCRY046
YZF-R1	07-08	SCRY070	SCRY072	SCRY071	SCRY068	SCRY069
YZF-R1	09-12	SCRY087	SCRY088	SCRY091	SCRY089	SCRY090

\* Standard screen



MotorGP  
 Exhausts  
 SCRsails  
 Commuter  
 Controls  
 Headlights  
 Indicators  
 Mirrors  
 Rear Lights  
 Lifts & Stands  
 Tools  
 Batteries & Chargers  
 Electrics  
 Chain  
 Servicing  
 Tyres & Tubes  
 Security  
 Bike Accs  
 Luggage  
 Rider Accs  
 Tank Pads  
 Extras

## Fly Screens

With headlight bracket fitting kit, this classic design fits round headlights, protecting clocks and wiring. Great for Bandits & Hornets



**Light Smoked**  
 Order Code: **SCRU020**



**Dark Smoked**  
 Order Code: **SCRU021**



**Iridium**  
 Order Code: **SCRU022**



**Blue**  
 Order Code: **SCRU023**

## Bubble Fly Screens

Complete with headlight bracket fitting kit. Suitable for all round headlights. The Bubble screen protects clocks and offers some rider wind protection.



**Dark Smoked**  
 Order Code: **SCRU024**



**Clear**  
 Order Code: **SCRU025**

## Tall Boy Fly Screens

The Tall Boy's shape offers a higher screen to create some wind protection for the rider. Perfect for commuters and tourers. With headlight bracket fitting kit. Suitable for all round headlights.



**Dark Smoked**  
 Order Code: **SCRU027**



**Clear**  
 Order Code: **SCRU028**



**Light Smoked**  
 Order Code: **SCRU026**



## Deluxe Highway Custom Shield

Premium acrylic custom windshield.  
Features integral high-chrome chassis  
Fully adjustable fitting kit, fits 22mm and 25mm bars

Order Code:  
**SCRU031**



## Dominator Fly Screens

Bespoke fly screen to fit the popular Dominator twin headlight. Includes headlight bracket fitting kit.



**Dark Smoked**  
Order Code: **SCRUDOM05**



**Light Smoked**  
Order Code: **SCRUDOM06**



**Blue**  
Order Code: **SCRUDOM07**



**Iridium**  
Order Code: **SCRUDOM08**

## Custom Blade Screens

Classic style acrylic custom blade screens available in Clear and Light Smoked. Both screens available with a Black or Chrome fitting kit (included) to fit 7/8 and 1" bars.



**Light Smoked**  
Order Code *Fitting kit colour*  
**SCRU016** *Black*  
**SCRU017** *Chrome*



**Clear**  
Order Code *Fitting kit colour*  
**SCRU018** *Black*  
**SCRU019** *Chrome*



Black and chrome fitting kit options.

## Screens and Deflector Kits for Harley Davidsons

BIKE	CLEAR	LIGHT SMOKED	DARK IRIDIUM
FLHT/FLHTC 96-05 (Short Screen)	<b>SCRL002</b>	<b>SCRL006</b>	<b>SCRL001</b>
FLHT/FLHTC 96-05 (Tall Screen)	<b>SCRL005</b>	<b>SCRL003</b>	<i>n/a</i>
FLHT/FLHTC 96-05 (Deflector Kit)	<b>SCRL008</b>	<b>SCRL009</b>	<b>SCRL007</b>

## Euro Fly Screens

'Euro' features a tall narrow design to protect clock and wiring. Fits all 7" round headlights using the headlight bracket kit supplied.

Order Code *Colour*  
**SCRU029** *Dark Smoked*  
**SCRU030** *Clear*



Motorcycle  
Exhausts  
Scooters  
Commuter  
Controls  
Headlights  
Indicators  
Mirrors  
Rear Lights  
Lifts & Stands  
Tools  
Batteries & Chargers  
Electrics  
Chain  
Servicing  
Tyres & Tubes  
Security  
Bike Accs  
Luggage  
Rider Accs  
Tank Pads  
Extras

## Screen Bolts

An 8pc pack of bolts to fit screens to fitting kits and fairings. Includes anodised bolts, protective nylon washers and nuts.

Order Code	Colour
<b>BOLSCRBLK</b>	Black
<b>BOLSCRBU</b>	Blue
<b>BOLSCRCH</b>	Chrome
<b>BOLSCRGD</b>	Gold
<b>BOLSCRR</b>	Red



## Screen Fairing Bolts

This bolt kit features threaded rubbers that fit directly into the lugs of fairings. Nylon washers offer protection to the screen from the anodised bolts. 8pcs per pack

Order Code	Colour
<b>BOLFAIRBLK</b>	Black
<b>BOLFAIRBU</b>	Blue
<b>BOLFAIRCH</b>	Chrome
<b>BOLFAIRGD</b>	Gold
<b>BOLFAIRR</b>	Red



## Spike Fairing Bolts

8pcs screen fairing bolt kit, featuring 'spike' bolt heads  
Includes threaded rubbers and nylon washers  
Silver colour

Order Code: **BOLSPKCH**



## Screen Trim

Coloured screen trims to colour co-ordinate Airblade screens to bikes. Each trim is 1m long (enough to trim two screens). Available in a range of colours.

Order Code	Colour	Length
<b>SCRTRIMBU</b>	Blue	1m
<b>SCRTRIMCH</b>	Chrome	1m
<b>SCRTRIMGD</b>	Gold	1m
<b>SCRTRIMR</b>	Red	1m
<b>SCRTRIMSM</b>	Smoked	1m
<b>SCRTRIMTR</b>	Transparent	1m



## POS Display Unit

Merchandising screens has always been a challenge, this superb POS display can be hung from slat wall, attached to a wall or suspended from the ceiling, for perfect presentation of Airblades' range of colour finishes.

Each screen is removeable from the display to allow customers to match against their bike for the ultimate in rider choice.

Surround the display with Bike It screen trim and fairing bolts for optimum upselling opportunities.

Display comes complete with 4 mini screens in Blue, Iridium, Dark Smoked and Clear finishes, and all accessories required.



Order Code: **POSAIR01**

\* Limited to one deal per customer

Motocp  
Exhausts  
Screens  
Commuter  
Controls  
Headlights  
Indicators  
Mirrors  
Rear Lights  
Lifts & Stands  
Tools  
Batteries & Chargers  
Electrics  
Chain  
Servicing  
Tyres & Tubes  
Security  
Bike Accs  
Luggage  
Rider Accs  
Tank Pads  
Extras  
www.bikeit.co.uk



## Filtrex Foam Scooter Air Filters

New from the Filtrex camp comes a range of replacement foam air filters for scooter applications.

Supplied pre-oiled for ease of use, the filters perform to allow maximum air flow in without sacrificing protection from particles and dirt.



Model	Order Code	Model	Order Code	Model	Order Code
<b>APRILIA</b>		<b>KYMCO</b>		Fly 50cc 4-Str <i>AIRC056</i>	
Area 51 LC 2-Str	<i>AIRC052</i>	B&W 50cc 2-Str	<i>AIRC068</i>	Liberty 4-Str	<i>AIRC048</i>
Gulliver 2-Str	<i>AIRC052</i>	Dink 50cc 2-Str	<i>AIRC068</i>	Liberty 50cc 2-Str	<i>AIRC074</i>
Rally - Rally LC 2-Str	<i>AIRC052</i>	DJ Refined 50cc 2-Str	<i>AIRC084</i>	LX 50cc 4-Str	<i>AIRC056</i>
Scarabeo 2-Str Street Piaggio	<i>AIRC082</i>	DJ-Y 50cc 2-Str	<i>AIRC096</i>	MC3 DD	<i>AIRC082</i>
Sonic LC 2-Str	<i>AIRC052</i>	DJ-Yes 50cc 2-Str	<i>AIRC084</i>	MC3 DT	<i>AIRC082</i>
SR 2-Str (1994/..)	<i>AIRC052</i>	K12 50cc 2-Str	<i>AIRC084</i>	NRG Extreme 2-Str	<i>AIRC080</i>
SR 2-Str www	<i>AIRC052</i>	KB50 50cc 2-Str	<i>AIRC084</i>	NRG LC 2-Str	<i>AIRC082</i>
SR LC 2-Str (2004) Carb Piaggio	<i>AIRC088</i>	Scout 50cc 2-Str	<i>AIRC084</i>	NRG LC 2-Str (1994/1996)	<i>AIRC086</i>
SR LC 2-Str Ditech Aprilia	<i>AIRC088</i>	Super 9 - 50cc 2-Str	<i>AIRC068</i>	NRG LC 2-Str MC2 (./1997)	<i>AIRC086</i>
SR LC 2-Str Ditech GP1 Piaggio	<i>AIRC088</i>	Top Boy 50cc 2-Str	<i>AIRC068</i>	NRG LC 2-Str MC2 (1998/..)	<i>AIRC080</i>
SR LC 2-Str Netscaper / Racing (Minarelli)	<i>AIRC052</i>	Yup 50cc 2-Str	<i>AIRC068</i>	NRG LC 2-Str MC3 Extreme	<i>AIRC082</i>
SR LC 2-Str Replica	<i>AIRC052</i>	ZX 50cc 2-Str	<i>AIRC084</i>	NRG LC 2-Str MC3 Purejet / Power	<i>AIRC080</i>
SR LC 2-Str Replica 2000 (morini motor)	<i>AIRC088</i>	<b>LAVARDA</b>		NTT 2-Str LC (1995/1996)	<i>AIRC086</i>
SR LC 2-Str Stealth (Minarelli)	<i>AIRC052</i>	Quasar 50cc 2-Str	<i>AIRC098</i>	Power DD LC	<i>AIRC082</i>
Stealth 50cc 2-Str	<i>AIRC098</i>	<b>MALAGUTI</b>		Sfera RST 50cc 2-Str Restyling	<i>AIRC070</i>
Atlantic 125cc LC 4-Str	<i>AIRC046</i>	Centro 2-Str	<i>AIRC098</i>	Vespa 2-Str ET-2 (carb) ET2 2000 - LX 2-Str	<i>AIRC070</i>
Sportcity 125cc LC 4-Str (Piaggio M281M)	<i>AIRC046</i>	Ciak 2-Str	<i>AIRC098</i>	Zip 2000	<i>AIRC082</i>
Atlantic 200cc LC 4-Str (Piaggio M234M)	<i>AIRC046</i>	F10 2-Str	<i>AIRC098</i>	Zip 2-Str 4-Str	<i>AIRC090</i>
Sportcity 200cc LC 4-Str (Piaggio)	<i>AIRC046</i>	F12 Phantom	<i>AIRC098</i>	Zip 2-Str Fast Rider (1993/1994)	<i>AIRC090</i>
Atlantic 250cc LC 4-Str (Piaggio M237M)	<i>AIRC046</i>	F12 Phantom LC 2-Str	<i>AIRC098</i>	Zip 2-Str Fast Rider (1996/1997)	<i>AIRC072</i>
Sportcity 250cc LC 4-Str (Pia. M288M) i.e Euro3	<i>AIRC046</i>	F12 Phantom LC 2-Str Digit Cat	<i>AIRC098</i>	Zip SP LC 2-Str (./2000)	<i>AIRC072</i>
Atlantic 400cc LC 4-Str Sprint (Piaggio M348M)	<i>AIRC046</i>	F12 Phantom LC 2-Str Digit Cat euro 2	<i>AIRC098</i>	Zip SP LC 2-Str (2001/..)	<i>AIRC082</i>
Atlantic 500cc LC 4-Str Sprint (Piaggio M273M)	<i>AIRC046</i>	Yesterday 2-Str	<i>AIRC098</i>	Beverly 125cc - 200cc LC 4-Str	<i>AIRC046</i>
<b>BENELLI</b>		Phantom Max 200cc LC 4-Str (Piaggio)	<i>AIRC046</i>	Liberty 125cc 4-Str	<i>AIRC070</i>
491 50cc 2-Str	<i>AIRC098</i>	Madison 250cc RS LC 4-Str (Piaggio M237M)	<i>AIRC046</i>	Skipper 2-Str LX - 150cc LXT	<i>AIRC044</i>
K12 50cc 2-Str	<i>AIRC098</i>	Phantom Max 250cc LC 4-Str (Piaggio M361M)	<i>AIRC046</i>	Vespa 4-Str ET-4 (1996/1998)	<i>AIRC070</i>
<b>BETA</b>		<b>MBK</b>		Liberty 200 - 200S 4-Str (Leader)	<i>AIRC048</i>
Ark 50cc 2-Str	<i>AIRC098</i>	Booster 2-Str euro 0-1 (1990/1994)	<i>AIRC094</i>	Beverly 250cc LC 4-Str (Piaggio M285M)	<i>AIRC046</i>
Chrono 50cc 2-Str	<i>AIRC098</i>	Booster 2-Str euro 2	<i>AIRC094</i>	X9 250cc LC 4-Str Evolution (Piaggio M237M)	<i>AIRC046</i>
Quadra 50cc 2-Str	<i>AIRC098</i>	Booster NG	<i>AIRC094</i>	Beverly 400cc LC 4-Str (Piaggio M345M)	<i>AIRC046</i>
Ycon 50cc 2-Str	<i>AIRC098</i>	Booster Spirit 2-Str euro 0-1 (1996/1998)	<i>AIRC094</i>	X8 400cc LC 4-Str i.e euro 3 (Piaggio M521M)	<i>AIRC046</i>
<b>CPI</b>		Evolis 2-Str (1994-1995)	<i>AIRC098</i>	Beverly 500cc LC 4-Str i.e euro 2-3	<i>AIRC046</i>
Hussar - Oliver 50cc 2-Str (2002)	<i>AIRC052</i>	Fizz	<i>AIRC098</i>	<b>PUCH</b>	
Popcorn 50cc 2-Str (./2002)	<i>AIRC052</i>	Flipper 2-Str	<i>AIRC076</i>	NRG 50cc 2-Str	<i>AIRC086</i>
<b>DERBI</b>		Forte	<i>AIRC098</i>	NTT 50cc 2-Str	<i>AIRC086</i>
Atlantis Bullet 2-Str (2006/..)	<i>AIRC082</i>	Hot Champ 2-Str	<i>AIRC098</i>	Typhoon 50cc 2-Str	<i>AIRC086</i>
GP1 - GP1 Open LC 2-Str	<i>AIRC082</i>	Mach G	<i>AIRC098</i>	Zip o.m. 50cc 2-Str	<i>AIRC090</i>
Senda 50cc 2-Str	<i>AIRC066</i>	Mach G LC 2-Str	<i>AIRC098</i>	<b>SUZUKI</b>	
GP1 125cc LC 4-Str euro2	<i>AIRC046</i>	Naked 2-Str euro 2	<i>AIRC094</i>	Burgman 400cc LC 4-Str AN (Business)	<i>AIRC042</i>
<b>DINLI</b>		Nitro LC 2-Str	<i>AIRC098</i>	Burgman 400cc LC 4-Str AN Inject (M237M)	<i>AIRC042</i>
Helix 2-Str DL603 50cc - 90cc	<i>AIRC098</i>	Ovetto 2-Str	<i>AIRC098</i>	<b>TGB</b>	
T-Rex 50cc 2-Str	<i>AIRC098</i>	Rocket 2-Str euro 0-1	<i>AIRC094</i>	202 - 50cc 2-Str	<i>AIRC060</i>
<b>GILERA</b>		Rocket 2-Str euro 2	<i>AIRC094</i>	203 - 50cc 2-Str	<i>AIRC060</i>
Dna 50cc LC 2Str	<i>AIRC082</i>	Sorriso 2-Str (1995/..)	<i>AIRC098</i>	303- 50cc 2-Str	<i>AIRC060</i>
Ice 2Str	<i>AIRC082</i>	Stunt 2-Str euro 2	<i>AIRC094</i>	<b>YAMAHA</b>	
Runner / Runner SP LC 2-Str (./2005)	<i>AIRC080</i>	<b>PEUGEOT</b>		Aerox LC 50cc 2-Str euro 0-1-2	<i>AIRC098</i>
Runner LC 2-Str SP-Carb (2006/..)	<i>AIRC082</i>	Buxy 50cc 2-Str	<i>AIRC092</i>	Axis 50cc 2-Str	<i>AIRC098</i>
Runner LC Purejet 2-Str (./2005)	<i>AIRC080</i>	Elyseo 50cc 2-Str	<i>AIRC092</i>	Booster 50cc 2-Str	<i>AIRC094</i>
Stalker 50cc 2-Str	<i>AIRC080</i>	Elystar 50cc 2-Str	<i>AIRC058</i>	Breeze 2-Str	<i>AIRC098</i>
Storm 2-Str	<i>AIRC086</i>	Fox 50cc 2-Str	<i>AIRC062</i>	Bump 50cc 2-Str	<i>AIRC094</i>
Typhoon 2-Str	<i>AIRC086</i>	Looxor	<i>AIRC092</i>	BW's - BW's Next Generation 2-Str euro 0-1	<i>AIRC094</i>
Dna 125cc - 180cc LC 4Str	<i>AIRC050</i>	Looxor TSDI	<i>AIRC092</i>	BW's - BW's Next Generation 2-Str euro 2	<i>AIRC094</i>
Runner 125cc FX LC 2-Str 180cc FXR	<i>AIRC044</i>	Metal-X 50cc 2-Str	<i>AIRC092</i>	Jog 50cc 2-Str	<i>AIRC098</i>
Runner 125cc VX LC 4-Str (./2005) 180cc VXR	<i>AIRC050</i>	Rapido 50cc 2-Str	<i>AIRC064</i>	Jog R 50cc 2-Str	<i>AIRC098</i>
Runner 125cc VX LC 4-Str (2005/..)	<i>AIRC046</i>	Speedake 50cc 2-Str	<i>AIRC092</i>	Jogz 50cc 2-Str	<i>AIRC098</i>
200cc VXR		Speedfight 2 50cc LC 2-Str (2004)	<i>AIRC092</i>	Neo's 50cc 2-Str	<i>AIRC098</i>
Nexus 250cc LC 4-Str i.e. Euro 3	<i>AIRC046</i>	Speedfight 50cc 2-Str	<i>AIRC092</i>	Spy 50cc 2-Str	<i>AIRC094</i>
<b>HONDA</b>		Squab 50cc 2-Str	<i>AIRC092</i>	Vino	<i>AIRC098</i>
SFX 50cc 2-Str	<i>AIRC078</i>	TKR 50cc 2-Str	<i>AIRC092</i>	Why 50cc 2-Str	<i>AIRC076</i>
Vision Met-In 50cc 2-Str	<i>AIRC096</i>	Trekker	<i>AIRC092</i>	Zest 50cc 2-Str	<i>AIRC098</i>
<b>ITALJET</b>		Vivacity 50cc 2-Str	<i>AIRC092</i>	Zuma 2-Str	<i>AIRC094</i>
Dragster 125cc - 180cc LC 2-Str	<i>AIRC044</i>	X-Fight	<i>AIRC092</i>		
		X-Fight 2-Str	<i>AIRC092</i>		
		X-Fight LC	<i>AIRC092</i>		
		Zenith 50cc 2-Str	<i>AIRC092</i>		
		<b>PIAGGIO</b>			
		Diesis 50cc 2-Str	<i>AIRC082</i>		
		ET2 50cc 2-Str	<i>AIRC070</i>		
		ET4 50cc 4-Str	<i>AIRC054</i>		

**FILTREX**  
WWW.FILTREXDEM.COM

Motocp  
Exhausts  
Screens  
Computer  
Controls  
Headlights  
Indicators  
Mirrors  
Rear Lights  
Lifts & Stands  
Tools  
Batteries & Chargers  
Electrics  
Chain  
Servicing  
Tyres & Tubes  
Security  
Bike Accs  
Luggage  
Rider Accs  
Tank Pads  
Extras



# Chain & Sprocket Kits



A winning combination of two proven products – Triple S chains and JT sprockets. Triple S chain, as developed by Team Yamaha UK's BSB and MX teams, is the perfect replacement chain for today's motorcycles.

Available in Standard, HD, O-Ring, X-Ring and now Solid Bush options. Here you will find a selection of Chain and Sprocket kits aimed at the small cc and commuter market. For the full listing of chains and sprocket kits please also check the CHAIN and OFF ROAD sections.

The listed chain and sprocket kits comprise the correct combination sprockets and chain type / grade for the bikes as stipulated by the manufacturer. Use of alternative chain will render warranty claims void.

NB; Bike It reserve the right to send an alternative length chain which will need to be cut to the correct length by the customer. If JT sprockets are not available Bike It will send an alternative brand.

Model	Year	Front	Rear	Notes	Chain	Manufacturers Recommended Chain Grade	STD	HD	O-RING	X-RING
<b>Aprilia</b>										
50RS	99-05	1120-12	23-47	#	420-122	STD	JTKARS5A		JTKARS5B	
	06-11	1128-11	1133-53	#	420-132	O-RING			JTKARS5B	
50SX	06-11	1128-11	1133-53	#	420-132	O-RING			JTKARS5B	
125 RS Extrema	93-03	394-16	701-39	ALTERNATE GEARING	520-108	HD	JTKARS1A		JTKARS1G	
125 RS Extrema	04-05	394-17	701-40	#	520-108	HD	JTKARS1D		JTKARS1J	
125 RS Replica	93-03	394-14	701-39	#	520-108	HD	JTKARS1B		JTKARS1K	
125 RS	06-11	394-17	703-40	#	520-110	O-RING			JTKARS1F	
125 Tuono	03-07	394-14	701-40	#	520-104	HD	JTKATU1A		JTKATU1B	
<b>Cagiva</b>										
125 Raptor	04-10	711-14	701-43	#	520-116	HD	JTKGRPT1A		JTKCMT1C	
125 Mito Evolution	92-99	711-14	701-41	#	520-114	HD	JTKCMT1B		JTKCMT1D	
125 Mito Evolution	00-04	711-14	701-39	ALTERNATE GEARING	520-114	HD	JTKCMT1A		JTKCMT1D	
125 Mito Euro 2	04-08	711-14	701-43	#	520-116	HD	JTKCRPT1A			
125 Mito SP525	08-10	711-14	701-43	#	520-116	HD	JTKCRPT1A			
<b>Derbi</b>										
50 Senda SM X-treme	00-05	1127-14	1131-53	#	420-130	HD	JTKD5SENA			
50 Senda SM/R X-treme	06-11	1128-11	1131-53	#	420-130	HD	JTKD5SENB			
50 Senda SM X-race	04-05	1127-14	1131-53	#	420-130	HD	JTKD5SENA			
50 Senda SM/R X-race	06-10	1128-11	1131-53	#	420-130	HD	JTKD5SENB			
<b>Honda</b>										
C90 CUB	84-02	253-15	211-39	#	420-98	STD	JTKHC90			
ANF125 Innova	03-11	249-14	212-35	#	420-104	STD	JTKHANF125A			
CBR125 R-4,5,6,7,8,9,A	04-10	1264-15	1206-42	#	428-124	HD	JTKHCBR1A			
CBR125 R-B	11-12	1264-15	1221-14	#	428-130	HD	JTKHCBR1B			
CBF125	09-11	1264-16	1219-42	#	428-118	HD	JTKHCBF1A			
CBF125 MC	12	1264-16	1219-42	#	428-118	HD	JTKHCBF1A			
CBZ125 EIRE	01	264-14	269-44	#	428-126	HD	JTKHCBZ1A			
CG125 Brazil	85-92	259-14	269-41	#	428-110	HD	JTKHCG125BA			
CG125 Brazil	93-98	259-14	269-41	#	428-114	HD	JTKHCG125BB			
CG125 E	98	259-15	269-36	#	428-112	HD	JTKHCG125E			
CG125	99-00	259-15	269-36	#	428-112	HD	JTKHCG125E			
CG125 W	01	259-15	269-36	#	428-112	HD	JTKHCG125E			
CG125 M1	02-05	259-14	269-43	#	428-116	HD	JTKHCG125F			
CG125	06>	259-14	218-44	ALTERNATE GEARING	428-116	HD	JTKHCG125A			
NSR125 R-R,S,V	93-98	327-14	604-36	#	520-108	HD	JTKHNSR1A			
NSR125 R-Y,1	99-02	327-14	604-38	#	520-110	HD	JTKHNSR1A			
VT125 C,C2 Shadow	99-07	327-14	279-41	#	520-112	HD	JTKHNSR1B			
XL125 V Varadero	01-11	327-14	273-44	#	520-110	O-RING	JTKHVT1A		JTKHXL1A	
XLR125 W-2	98-02	1264-17	1249-51	#	428-130	HD	JTKHXL1A			
XR125 L-3,4,5,6,7	03-07	1264-17	1258-54	#	428-132	HD	JTKHXR1A			
CB250 N Two Fifty	92-02	287-14	272-31	#	520-104	O-RING	JTKHCB2A			
CB250 Night Hawk	99-08	287-14	279-33	#	520-106	O-RING	JTKHCBF25B			
CBF250	04-06	1321-13	254-37	#	520-106	O-RING	JTKHCBF25A			

\* 513-15 = 566-15

- MotorGP
- Exhausts
- Screens
- Commuter
- Controls
- Headlights
- Indicators
- Mirrors
- Rear Lights
- Lifts & Stands
- Tools
- Batteries & Chargers
- Electrics
- Chain
- Servicing
- Tyres & Tubes
- Security
- Bike Accs
- Luggage
- Rider Accs
- Tank Pads
- Extras

# Chain & Sprocket Kits

Model	Year	Front	Rear	Notes	Chain	Manufacturers Recommended Chain Grade	STD	HD	O-RING	X-RING
* 513-15 = 566-15										
CBR250 R	11-12	1321-14	1220-38	#	520-108	O-RING			JTKHCBR2A	
CB500 R,S,T,V,W	94-03	297-15	1332-40	#	525-108	O-RING			JTKHCB5A	
CB500 S-W,X,Y,1,2,3	98-03	297-15	1332-40	#	525-108	O-RING			JTKHCB5A	
CBF500/ABS	04-08	297-15	1304-41	#	525-116	O-RING			JTKHCBF50A	
<b>Hvosung</b>										
GV125 C/Aquila	01-10	410-14	810-48	ALTERNATE GEARING	428-138	HD		JTKHYGV1A		
GT125 Naked	03-08	410-14	1067-52	#	428-138	HD		JTKHYGT1A		
GT125R Supersport	06-08	410-14	1067-52	#	428-138	HD		JTKHYGT1A		
RT125 Karion D Citytrail	08-10	410-13	810-48	#	428-128	HD		JTKHYRT1A		
RX125 D	07-11	410-14	810-48	#	428-132	HD		JTKHYRX1A		
XR125 Funduro	07-08	410-14	810-48	#	428-132	HD		JTKHYRX1A		
GT250 Sport R	04-08	1554-14	1068-46	#	520-112	O-RING		JTKHYGT2A		
GT250 Comet / FI	06-10	1554-14	1068-46	#	520-112	O-RING		JTKHYGT2A		
<b>Kawasaki</b>										
BN125 Eliminator A1-A9F	98-09	417-15	468-46	#	428-132	HD		JTKKBM125A		
KMX125 A1-5, B1-12	86-03	417-14	463-48	#	428-124	HD		JTKKMM125A		
EX250R Ninja K8F-KBF	08-12	1539-14	486-43	#	520-106	O-RING		JTKKEX2B		
KLX250 SF W9F, WAF	09-10	516-13	460-39	#	520-104	O-RING		JTKKKLX25A		
KLX250 S TCF	12	516-14	460-42	#	520-106	O-RING		JTKKKLX25B		
EN500 Vulcan C1-C10	96-05	512-16	1490-42	#	520-110	O-RING		JTKKEN5A		
ER-5 (ER500) A1-A4, C1-C4, Twister	97-06	512-17	486-42	#	520-106	O-RING		JTKKER5A		
GPZ500 S D1-12	94-05	512-16	486-41	#	520-104	O-RING		JTKKGPZ5A		
KLX500 B6F,B7F	06-07	512-17	487-44	#	520-110	O-RING		JTKKKL5A		
<b>Suzuki</b>										
DR-Z125 K3-K9, L0	03-10	409-14	797-51	#	428-134	HD		JTKSDRZ1A		
DR-Z125 L K3-K9, L0	03-10	409-14	797-57	#	428-134	HD		JTKSDRZ1B		
FL125 SDW Address	07-10	273-14	802-34	#	428-100	HD		JTKSFL1A		
GZ125 Marauder	98-10	410-15	1794-45	#	428-132	HD		JTKSGZ125A		
RV125 K3-K6 Van Van	03-06	425-15	1796-51	#	428-134	HD		JTKSRV1A		
RV125 K7-L0 Van Van	07-10	425-15	1796-49	#	428-134	HD		JTKSRV1B		
VL125 Intruder LC	00-07	410-14	1806-56	#	428-142	HD		JTKSVL1A		
DR-Z250 K1-K7	01-07	432-13	808-49	ALU REAR	520-112	O-RING		JTKSDRZ25A		
DR-Z400S K1-L2	00-12	432-15	808-44	#	520-112	O-RING		JTKSDRZ4A		
DR-Z400 E K1-K7	01-07	432-14	808-47	#	520-112	O-RING		JTKSDRZ4B		
DR-Z400 SM 05-L0	05-10	432-15	808-41	#	520-112	O-RING		JTKSDRZ4C		
GS500 E-R,S,T,V,W (2 cyl)	94-98	516-16	823-39	#	520-112	O-RING		JTKSGS5A		
GS500 E-YK1-K7	99-07	516-16	823-39	#	520-110	O-RING		JTKSGS5B		
GS500F K4-L0	04-10	516-16	823-39	#	520-110	O-RING		JTKSGS5B		
<b>Yamaha</b>										
DT125X	05-06	558-16	839-57	#	428-134	HD		JTKYDTR1A		
DT125 (DT125R)	90-03	558-16	839-57	#	428-134	HD		JTKYDTR1A		
DT125 RE	04-06	558-16	839-57	#	428-134	HD		JTKYDTR1A		
SR125	95-03	1263-14	835-49	#	428-120	HD		JTKYSR1A		
WR125 R/X -Y,A	09-11	1550-14	839-53	#	428-134	HD		JTKYWR1A		
XT125 X	05-09	1263-14	1134-48	#	428-126	HD		JTKYXT1A		
XT125 R	05-09	1263-14	1134-50	#	428-128	HD		JTKYXT1B		
XVS125 Drag Star	00-04	564-13	857-47	520 CONVERSION	520-116	HD		JTKYXVS1A		
YBR125	05-06	1263-14	838-45	#	428-118	HD		JTKYYBR1A		
YBR125	07-12	548-14	838-45	#	428-118	HD		JTKYYBR1B		
YBR125 Custom	08-12	548-14	838-43	#	428-118	HD		JTKYYBR1C		
YZF125R	08-12	1550-14	1844-48	#	428-132	HD		JTKYYZF125A		
TW200 B1 10DM	12	1559-14	1842-50	#	428-122	HD		JTKYTW2A		
WR250 R XY	08-12	1590-13	245/243	#	520-108	HD		JTKYWR250C		
WR250 X XY	08-12	1590-13	245/242	#	520-108	HD		JTKYWR250D		
XT250 X-B	08-12	1594-15	1847-48	#	428-128	HD		JTKYXT2A		
YBR250	07-10	1594-15	1870-44	#	428-132	HD		JTKYXT2A		

- Motorcycle
- Exhausts
- Screens
- Computer
- Controls
- Headlights
- Indicators
- Mirrors
- Rear Lights
- Lifts & Stands
- Tools
- Batteries & Chargers
- Electrics
- Chain
- Servicing
- Tyres & Tubes
- Security
- Bike Accs
- Luggage
- Rider Accs
- Tank Pads
- Extras

## Commuter Levers

OEM replacement levers are available as individual brake and clutch levers available in standard alloy finish (except where shown\* when the original colour is black).

Model	Year	Clutch	Brake
<b>Aprilia</b>			
RS 125	92-05	LRA01C	LRA01B
RS 125	05-10	LRA01C	TBC
<b>Honda</b>			
ANF 125 Innova	03-09	N/A	LRH20B
CBF 125	09-10	LRH22C*	LRH22B*
CBR 125R	04>	LRH14C	LRH14B
CG125 W	97-01	LRH16C	LRH16B
CG125 M	01-04	LBH20C*	LBH20B*
FES 125	98-02	#	LRH26B
FES 125	03-11	#	LRH25B
SES 125 Dylan	03-04	LRH21C	LRH21B
SH 125	01-03	LRH21C	LRH21B
VT 125	99-06	LRH27C	N/A
XL 125 Varadero	01-03	LRH28C*	LRH28B*
XL 125 Varadero	04-12	LRH29C	LRH28B
XLR 125	98>	LRH24C*	LRH24B*
XR 125 R	03-08	LRH23C*	LRH23B*
CBF 500	04-06	TBC	TBC
CBF 600	07	LRH08C	LRH08B
CBF 600	08-09	TBC	TBC
CB 600 Hornet SF-S6	98-06	LRH08C	LRH08B
CB 600 F HORNET	07-12	TBC	TBC
<b>Kawasaki</b>			
BN 125 Eliminator	98-04	LRK09C	LRK09B
ER-5 A1	96	LRK04C	LRK04B
ER-5 A2/3/4	97-00	LRK03C	LRK03B
ER-5 C1>	01>	LRK03C	LRK03B
ER-5	04-05	LRK08C	LRK08B
GPZ500S A6-D6	92-99	LRK03C	LRK03B
KLE500	91-97	LRK08C	LRK08B
ZR550 Zephyr B2-B6	91-98	LRK03C	LRK03B
ER-6 F/N	06-11	LRK10C	LRK10B
ER-6 F/N	12	LRK10C	TBC
Versys	06-12	LRK08C	LRK08B
ZR-7/S	99-03	LRK08C	LRK08B
<b>Suzuki</b>			
GZ 125 X-K2 Marauder	98-02	LRS17C	LRS17B
RG 125F Gamma / Wolf	92-95	LRS08C	LRS08B
RV 125	03-04	LRS18C	LRS18B
UH 125 Burgman	02-04	LRS19C	LRS18B
VL 125 Intruder	99-08	LRS18C	LRS20B
GSF 400 Bandit	91-95	LRS01C	LRS01B
GS 500E L	89>	LRS08C	LRS08B
GS500F K4>	04>	LRS08C	LRS08B
GSF600/S Bandit S-X	95-99	LRS08C	LRS08B
GSF600/S Bandit Y-K4	00-04	LRS10C	LRS10B
GSR 600	06-11	LRS03C	LRS03B
GSX600 FK-FX	89-98	LRS01C	LRS01B
GSF650 Bandit (oil cooled)	05-06	LRS16C	LRS16B
GSF650 Bandit (water cooled)	07-12	LRS04C	LRS04B
GSX 650F	08-12	LRS04C	LRS04B
SV650 / S	99-08	LRS01C	LRS01B
SV650 / S	09-12	LRS03C	LRS03B
SFV 650 Gladius	09-12	LRS03C	LRS01B
<b>Yamaha</b>			
DT 125 RE	04-06	LRV22C	LRV22B
DT 125 X	05-06	LRV22C	LRV22B
Majesty YP125	01-04	LRV20C*	LRV20B*
SR 125	92-00	LRV24C	LRV21B
TW125	00-04	LRV22C	LRV22B
XQ 125 Maxster	02-04	LRV30C	LRV30B
XT125R	05-07	LRV19C*	LRV19B*
XVS125 Dragstar	00-04	LRV21C	LRV21B
YBR125	05-08	LRV11C	LRV11B
YZF-R 125	08>	LRV18C	LRV18B
FZ 600 Fazer	97-03	LRV09C	LRV09B
FZ6-Fazer	04-10	LRV10C	LRV10B
XJ 600S	92-96	LRV13C	LRV13B
XJ 600 N	96>	LRV13C	LRV13B
XJ6 / Diversion	09-12	LRV10C	LRV10B





## BikeTek Heated Grips

Exclusive BikeTek heated grip set, provides efficient heat to rider's hands whilst riding, essential for cold winter riding. Multi-heat settings provide perfect heating for all conditions. Simple two button controller box can be handlebar mounted for ease of on-ride use. Detail grip pattern for optimum feel. Easy installation onto all 22mm handlebars (22mm left, 25mm right grip). Supplied complete with bar-ends plugs.

Order Code: **GRPHT11**



Bar end plug



Control box



Control box mount



**BIKETEK**

## Road Grips - Pairs



### Twin Ring

Order Code	Colour	Size
<b>GRPRD30</b>	Titanium	22mm left, 25mm right
<b>GRPRD33</b>	Titanium	25mm left, 25mm right



### Foam & Chrome

Order Code	Size
<b>GRPFCH22</b>	22mm left, 25mm right
<b>GRPFCH25</b>	25mm left, 28mm right
<b>GRPRD11</b>	25mm left, 25mm right



### Lambretta

Order Code	Size
<b>GRPRD09</b>	25mm left, 25mm right



### Black Original

Order Code: **GRPBRORI**



### Black Lozenge

Order Code: **GRPBR058**



### Black Tena

Order Code: **GRPBR TENA**



### Black Ovals

Order Code: **GRPBR028**



### Black Honda Type

Order Code: **GRPBRHON**



### Black Rippled

Order Code: **GRPBR018**

Motocp  
Exhausts  
Screens  
Commuter  
Controls  
Headlights  
Indicators  
Mirrors  
Rear Lights  
Lifts & Stands  
Tools  
Batteries & Chargers  
Electrics  
Chain  
Servicing  
Tyres & Tubes  
Security  
Bike Accs  
Luggage  
Rider Accs  
Tank Pads  
Extras

## High Performance Dry Charge (DB Series)

20-30% more starting power than conventional batteries, more plates per cell give higher cranking performance. Extra power for machines with additional electrical components or high compression engines.

Order Code	Dynavolt Ref	Alt. Ref	ACID Packs Req.
CB25LC	DB25L-C	YB2.5L-C	1
CB3LA	DB3L-A	YB3L-A	1
CB3LB	DB3L-B	YB3L-B	1
CB4LA	DB4L-A	YB4L-A	1
CB4LB	DB4L-B	YB4L-B	1
CB5LB	DB5L-B	YB5L-B	1
CB7A	DB7-A	YB7-A	2
CB7CA	DB7C-A	YB7C-A	2
CB7LB2	DB7L-B2	CB7L-B2	2

Supplied dry without electrolyte.  
Order electrolyte packs as detailed.



## Gel Nanotechnology (MG Series)

### High Performance MG...

An advanced range of sealed activated models (MG). Utilising a real gel electrolyte, rather than liquid, able to fully cover the active material all the time, providing a larger effective surface area and prevent lead from sulphation.

Order Code	Dynavolt Ref	Alt. Ref
MG4ABS	MG4ABS	YTX4A-BS
MG4BBS	MG4BBS	YTX4B-BS / YT4B-5
MG6ZS	MG6ZS	YTZ6-S
MG7B4	MG7B4	YT7B-4
MG7ZS	MG7ZS	YTZ7-S

## Conventional Dry Charge (6N & 12N Series)

Standard replacement dry charge batteries. General dependable power. High cranking power

Order Code	Dynavolt. Ref	ACID Packs Req.
6CB83B	6DB8-3B	1
6N112D	6N11-2D	2
6N11A1B	6N11A-1B	2
6N11A4	6N11A-4	2
6N11A4A	6N11A-4A	2
6N12A2C	6N12A-2C	1
6N12A2D	6N12A-2D	1
6N22A	6N2-2A	1
6N22A8	6N2-2A-8	1
6N42A	6N4-2A	1
6N42A2	6N4-2A-2	1
6N42A4	6N4-2A-4	1
6N42A5	6N4-2A-5	1
6N42A7	6N4-2A-7	1
6N4A4D	6N4A-4D	1
6N4B2A	6N4B-2A	1
6N4B2A3	6N4B-2-A3	1
6N4B2A4	6N4B-2A-4	1
6N551D	6N5.5-1D	1
6N61B	6N6-1B	1
6N61C	6N6-1C	1
6N61D2	6N6-1D-2	1
6N63B	6N6-3B	1
6N63B1	6N6-3B-1	1

Supplied dry without electrolyte.  
Order electrolyte packs as detailed.

## Gel Nanotechnology Upgrades

### MG versions of DTX and DB models.

Dynavolt have taken some of the most popular maintenance free and conventional battery models (eg DTX9BS and DB4L-B) and developed upgrade batteries using MG technology. These upgrade batteries offer improved battery performance over the original battery type, and as they are factory sealed and activated they do not require acid-filling to commission.

### GEL NANO UPGRADE - DTX Series

Order Code	Upgrade from	Alt. Ref
MG4LBS	DTX4L-BS	YTX4L-BS
MG5LBS	DTX5L-BS	YTX5L-BS
MG7ABS	DTX7A-BS	YTX7A-BS
MG7LBS	DTX7L-BS	YTX7L-BS

### GEL NANO UPGRADE - DB Series

Order Code	Upgrade from	Alt. Ref
MGCB4LB	DB4L-B	YB4L-B
MGCB5LB	DB5L-B	YB5L-B
MGCB9B	DB9-B	YB9-B

## Conventional Sealed Activated Batteries

Dynavolt factory-activated sealed batteries are supplied pre-charged and require no acid-filling to commission. This range is targeted as direct standard replacement for OE batteries fitted to the majority of the latest motorcycles.

Order Code	Dynavolt Ref	Alt. Ref
MGS6ZS	MGS6ZS	YTZ6-S
MGS7B4	MGS7B4	YT7B-4
MGS7ZS	MGS7ZS	YTZ7-S



## Maintenance Free With Acid Packs (DTX Series)

Valve regulated lead acid batteries once activated, are totally sealed. This eliminates spills and leakages, making them particularly suitable for motorcycles, ATVs and personal watercraft. Each battery is supplied with an easy-fill acid pack for activation, no further maintenance or topping up is required. Robust and vibration resistant, maintenance free batteries last up to three times longer than conventional batteries.

Order Code	Dynavolt Ref	Alt. Ref
YTX4LBS	DTX4L-BS	YTX4L-BS
YTX5LBS	DTX5L-BS	YTX5L-BS
YTX7ABS	DTX7A-BS	YTX7A-BS
YTX7LBS	DTX7L-BS	YTX7L-BS



MotorGP  
 Exhausts  
 Screens  
 COMPUTER  
 Controls  
 Headlights  
 Indicators  
 Mirrors  
 Rear Lights  
 Lifts & Stands  
 Tools  
 Batteries & Chargers  
 Electrics  
 Chain  
 Servicing  
 Tyres & Tubes  
 Security  
 Bike Accs  
 Luggage  
 Rider Accs  
 Tank Pads  
 Extras  
 www.bikeoil.co.uk



## Tubeless Scooter Tyres 10"-14"

A comprehensive range of tubeless scooter tyres available for the majority of today's scooters.

All tyres are fully E-mark compliant to ECE No.75, offering great grip and wear-rates.

Tyres supplied are Cougar brand wherever possible, if Cougar is not available Bike It will send an alternative brand of equivalent specification.

Order Code	Size	Tread	Fitment
<b>10"</b>			
TTL10350U	350-10	8302	F/R
TTL1013070	130/70-10	931	F/R
TTL1010080	100/80-10	926	F/R
TTL109090U	90/90-10	8001	F/R
TTL1010090	100/90-10	822	F/R
TTL1012070	120/70-10	931	F/R
TTL1012090	120/90-10	809	F/R
TTL1012090U	120/90-10	822	F/R
TTL1013090U	130/90-10	822	F/R
<b>11"</b>			
TTL1112070	120/70-11	806	F/R
<b>12"</b>			
TTL1212070	120/70-12	805/930/996	F/R
TTL1213070	130/70-12	805/930/996	F/R
TTL1214070	140/70-12	805/931	F/R
TTL1212080	120/80-12	805	F/R
TTL1211090	110/90-12	930	F/R
<b>13"</b>			
TTL1313060	130/60-13	805/931/ 930	F/R
TTL1314060	140/60-13	931/ 930	F/R
TTL1314060U	140/60-13	805	F/R
TTL1312070	120/70-13	806	F/R
TTL1313070	130/70-13	930	F/R
TTL1311090	110/90-13	806	F/R
<b>14"</b>			
TTL1412070	120/70-14	931/930	F/R
TTL1415070	150/70-14	820	F/R

### SPEED RATING REFERENCE

Ensure the correct rated tyres are used as per manufacturer recommendations.

Speed Index	Mph	Kmh
J	62	100
L	75	120
M	81	130
N	87	140
P	93	150
R	106	170
S	112	180
H	130	210

Tread pattern > **805**



Available in:

- 120/80-12
- 100/80-17
- 120/70-12
- 130/70-12
- 140/70-12
- 130/60-13
- 140/60-13

**SPEED INDEX M-L**

Tread pattern > **806**



Available in:

- 120/70-13
- 110/90-13
- 120/70-11

**SPEED INDEX P**

Tread pattern > **807**

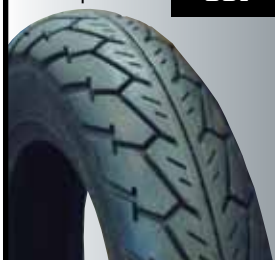

Available in:

- 90/90-10

**SPEED INDEX L**

Tread pattern > **809**



Available in:

- 120/90-10

**SPEED INDEX L**

Tread pattern > **820**



Available in:

- 150/70-14

**SPEED INDEX S**

Tread pattern > **822**



Available in:

- 100/90-10
- 120/90-10
- 130/90-10

**SPEED INDEX L**

Tread pattern > **8302**

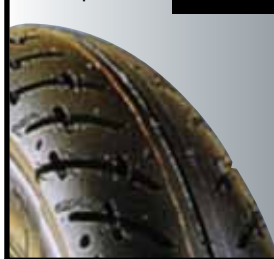

Available in:

- 350-10

**SPEED INDEX J**

Tread pattern > **926**



Available in:

- 100/80-10

**SPEED INDEX M**

Tread pattern > **996**



Available in:

- 120/70-12
- 130/70-12

**SPEED INDEX L**

Tread pattern > **931**

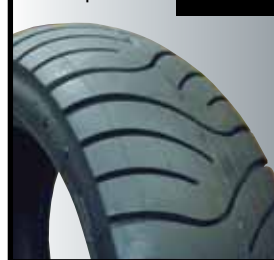

Available in:

- 140/70-12
- 130/60-13
- 140/60-13
- 120/70-10
- 120/70-14
- 130/70-10

**SPEED INDEX M**

Tread pattern > **930**



Available in:

- 110/90-12
- 120/70-14
- 120/70-12
- 130/70-12
- 130/70-13
- 130/60-13
- 140/60-13

**SPEED INDEX M**

Tread pattern > **8001**



Available in:

- 90/90-10

Motorcycle  
Exhausts  
Screens  
Commuter  
Controls  
Headlights  
Indicators  
Mirrors  
Rear Lights  
Lifts & Stands  
Tools  
Batteries & Chargers  
Electrics  
Chain  
Servicing  
Tyres & Tubes  
Security  
Bike Accs  
Luggage  
Rider Accs  
Tank Pads  
Extras



MotoGP  
 Exhausts  
 Screens  
 COMPUTER  
 Controls  
 Headlights  
 Indicators  
 Mirrors  
 Rear Lights  
 Lifts & Stands  
 Tools  
 Batteries & Chargers  
 Electrics  
 Chain  
 Servicing  
 Tyres & Tubes  
 Security  
 Bike Accs  
 Luggage  
 Rider Accs  
 Tank Pads  
 Extras  
 www.bikeit.co.uk

## Tube Type Road Tyres 8"-18"

Tube-type tyres for road bikes, offered in all popular sizes from 8" to 18".

All tyres are fully E-mark compliant to ECE No.75, offering great grip and wear-rates.

Tyres supplied are Cougar brand wherever possible, if Cougar is not available Bike It will send an alternative brand of equivalent specification.

Order Code	Size	Tread	Fitment
<b>8"</b>			
TTT8350L	350-8	871	F/R
TTT8350U	350-8	932	F/R
<b>10"</b>			
TTT10275G	275-10	929	F/R
TTT10300J	300-10	955	F/R
TTT10350C	350-10	894	F/R
TTT109090J	90/90-10	955	F/R
<b>16"</b>			
TTT16350A	350-16	876	R
<b>17"</b>			
TTT17225D	225-17	911	F/R
TTT17250M	250-17	861	F
TTT17250E	250-17	918	F/R
TTT17250K	250-17	874	F/R
TTT17275M	275-17	861	F
TTT17275F	275-17	201	F
TTT17275A	275-17	876	R
TTT17300P	300-17	722	F/R
TTT17300A	300-17	876	R
TTT17325A	325-17	876	R
<b>18"</b>			
TTT18250N	250-18	860	F
TTT18250E	250-18	918	F/R
TTT18250L	250-18	871	R
TTT18275N	275-18	860	F
TTT18275A	275-18	876	R
TTT18300A	300-18	876	R

### SPEED RATING REFERENCE

Ensure the correct rated tyres are used as per manufacturer recommendations.

Speed Index	Mph	Kmh
J	62	100
L	75	120
M	81	130
N	87	140
P	93	150
R	106	170
S	112	180
H	130	210

Tread pattern > **201**



Available in: 275-17

**SPEED INDEX P**

Tread pattern > **201**

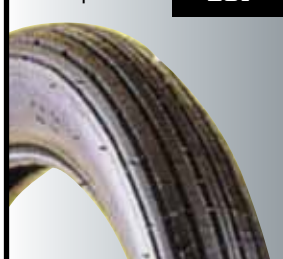

Available in: 250-18

**SPEED INDEX L**

Tread pattern > **861**

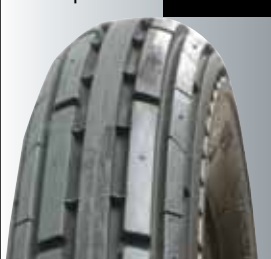

Available in: 275-17, 250-17

**SPEED INDEX N**

Tread pattern > **874**



Available in: 250-17

**SPEED INDEX N**

Tread pattern > **876**



Available in: 275-17, 275-18, 300-17, 300-18, 325-17, 350-16

**SPEED INDEX N**

Tread pattern > **894**

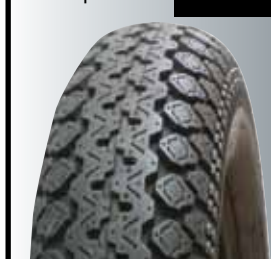

Available in: 350-10

**SPEED INDEX N**

Tread pattern > **911**



Available in: 225-17

**SPEED INDEX N**

Tread pattern > **918**

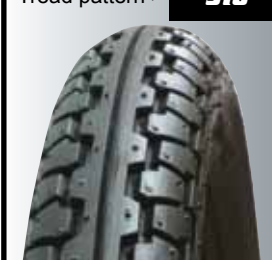

Available in: 250-18, 250-17

**SPEED INDEX N**

Tread pattern > **929**



Available in: 275-10

**SPEED INDEX N**

Tread pattern > **932**



Available in: 350-8

## Tube Type Road Tyres 8"-18" cont...

Tread pattern > **955**



Available in:  
90/90-10  
300-10

**SPEED INDEX**  
**N**

Tread pattern > **722**



Available in:  
300-17

**SPEED INDEX**  
**N**

Tread pattern > **860**

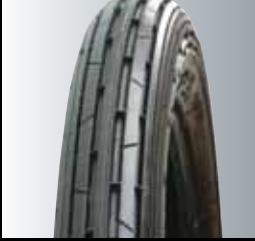

Available in:  
250-18  
275-18

**SPEED INDEX**  
**N**

Tread pattern > **871**



Available in:  
350-8  
250-18

**SPEED INDEX**  
**N**

## Heavy Duty Butyl Inner Tubes

Premium quality motorcycle inner tubes. Manufactured from extra durable and hard-wearing butyl, providing excellent performance both on and off-road, featuring precision brass Schrader valve with dust cap.

Order Code	Valve	Size
<b>10"</b>		
ITB10250275	TR4/TR6	250/275-10
ITB10250275A	TR87	250/275-10
ITB10275300	TR4/TR6	275/300-10
ITB10275300A	TR87	275/300-10
ITB10350400A	TR87	350/400-10
ITB1010080A	TR87	100/80-10

<b>12"</b>		
ITB12300350	TR4/TR6	300/325/350-12
ITB1212070A	TR87	120(130)/70-12

<b>14"</b>		
ITB14225250	TR4/TR6	225/250-14
ITB14250275	TR4/TR6	250/275-14
ITB14350400	TR4/TR6	350/400-14

<b>15"</b>		
ITB15450510A	TR87	450/510-15

<b>16"</b>		
ITB16225250	TR4/TR6	225/250-16
ITB16250275	TR4/TR6	250/275-16
ITB16275300	TR4/TR6	275/300-16
ITB16300325	TR4/TR6	300/325-16
ITB16325350	TR4/TR6	325/350-16
ITB16350400	TR4/TR6	350/400-16
ITB16400450	TR4/TR6	400/450-16
ITB16450510	TR4/TR6	450/510-16

Order Code	Valve	Size
<b>17"</b>		
ITB17225250	TR4/TR6	225/250-17
ITB17275300	TR4/TR6	275/300-17
ITB17325350	TR4/TR6	325/350-17
ITB17350400	TR4/TR6	350/400-17
ITB17400450	TR4/TR6	400/450-17
ITB17450510	TR4/TR6	450/510-17

<b>18"</b>		
ITB18225250	TR4/TR6	225/250-18
ITB18250275	TR4/TR6	250/275-18
ITB18275300	TR4/TR6	275/300-18
ITB18300325	TR4/TR6	300/325-18
ITB18325350	TR4/TR6	325/350-18
ITB18350400	TR4/TR6	350/400-18
ITB18400450	TR4/TR6	400/450-18
ITB18450510	TR4/TR6	450/510-18

<b>19"</b>		
ITB19225250	TR4/TR6	225/250-19
ITB19275300	TR4/TR6	275/300-19
ITB19325400	TR4/TR6	325/350/400-19
ITB19400450	TR4/TR6	400/450-19

<b>21"</b>		
ITB21250300	TR4/TR6	250/275/300-21



Motorcycle  
Exhausts  
Screens  
Commuter  
Controls  
Headlights  
Indicators  
Mirrors  
Rear Lights  
Lifts & Stands  
Tools  
Batteries & Chargers  
Electrics  
Chain  
Servicing  
Tyres & Tubes  
Security  
Bike Accs  
Luggage  
Rider Accs  
Tank Pads  
Extras

## Viper Scooter Silencers

Viper's range of reverse sports silencers are available for most of today's scooters. Homologated for road use, the reversed and downward end can is designed to improve power and speed over the original manufacturer's silencer.

It must be noted that the consequential increase in speed and power may render the scooter too powerful for the legal limit set for learner riders.

All silencers are available in a choice of 2

body finishes, "original smoked varnish" and "high chrome". Both types feature stylish black end cans with the VIPER logo.



MODEL	SMOKED SILENCER	CHROME SILENCER	CLUTCH ROLLERS
<b>ALUNIX</b>			
Alunix 50	VIP375	VIP375CH	VIPROLA
<b>APRILIA</b>			
SR 01-03 Franco Morini*	VIP379	VIP379CH	VIPROLD
SR 04> Piaggio engine*	VIP040	VIP040CH	VIPROLB
Scarabeo	VIP375	VIP375CH	VIPROLA
Scarabeo Morini	VIP379	VIP379CH	VIPROLD
SR 50 >94 Minarelli Horiz	VIP375	VIP375CH	VIPROLA
SR '00 Morini	VIP379	VIP379CH	VIPROLD
Rally	VIP375	VIP375CH	VIPROLA
Company Custom (Piaggio engine)	VIP040	VIP040CH	VIPROLB
Sportcity One 2T	VIP040	VIP040CH	VIPROLB
SR Factory	VIP375	VIP375CH	VIPROLA
Sonic	VIP375	VIP375CH	VIPROLA
Area 51	VIP375	VIP375CH	VIPROLA
Gulliver	VIP375	VIP375CH	VIPROLA
<b>BENELLI</b>			
491 Strada	VIP375	VIP375CH	VIPROLA
Namur	VIP375	VIP375CH	VIPROLA
491 RR 50 (Minarelli engine)	VIP375	VIP375CH	VIPROLA
K2 50	VIP375	VIP375CH	VIPROLA
Pepe	VIP375	VIP375CH	VIPROLA
Pepe LX	VIP375	VIP375CH	VIPROLA
Quattro Nove X	VIP375	VIP375CH	VIPROLA
<b>BETA</b>			
Chrono/Ch 502	VIP375	VIP375CH	VIPROLA
Tempo 13-16	VIP375	VIP375CH	VIPROLA
Quadra	VIP375	VIP375CH	VIPROLA
ARK	VIP375	VIP375CH	VIPROLA
Eikon 50	VIP375	VIP375CH	VIPROLA
<b>DERBI</b>			
GP1 <05	VIP040	VIP040CH	VIPROLB
Atlantis (Piaggio engine)	VIP040	VIP040CH	VIPROLB
Easy	VIP375	VIP375CH	VIPROLA
GP1 50 Open	VIP040	VIP040CH	VIPROLB
Sonar 50	VIP040	VIP040CH	VIPROLB
Variant Sport 50	VIP040	VIP040CH	VIPROLB
Boulevard 50	VIP040	VIP040CH	VIPROLB
<b>E-ton</b>			
Beamer	VIP380		VIPROLA
Beamer III	VIP380		VIPROLA
Sport 50	VIP380		VIPROLA
Matrix 50	VIP380		VIPROLA
<b>GENUINE</b>			
Buddy 50	VIP375	VIP375CH	VIPROLA
Roughhouse R50	VIP375	VIP375CH	VIPROLA

MODEL	SMOKED SILENCER	CHROME SILENCER	CLUTCH ROLLERS
<b>GILERA</b>			
DNA	VIP040	VIP040CH	VIPROLC
Easy Moving	VIP040	VIP040CH	VIPROLB
Typhoon 50	VIP040	VIP040CH	VIPROLB
Runner 50	VIP040	VIP040CH	VIPROLB
Ice	VIP040	VIP040CH	VIPROLB
Stalker	VIP040	VIP040CH	VIPROLB
<b>ITALJET</b>			
Formula 50 Minarelli	VIP375	VIP375CH	VIPROLA
Jet Set 50	VIP040	VIP040CH	VIPROLB
Torpedo 50 (Piaggio engine)	VIP040	VIP040CH	VIPROLB
Dragster 50	VIP375	VIP375CH	VIPROLA
Formula 50 (Minarelli Horiz)	VIP375	VIP375CH	VIPROLA
<b>MALAGUTI</b>			
F10 Jetline 50	VIP375	VIP375CH	VIPROLA
F12 Phantom 50	VIP375	VIP375CH	VIPROLA
F15 Firefox 50	VIP375	VIP375CH	VIPROLA
Ciak 50	VIP375	VIP375CH	VIPROLA
Yesterday 50	VIP375	VIP375CH	VIPROLA
<b>MBK</b>			
Evolis 50-80	VIP375	VIP375CH	VIPROLA
Flipper 50	VIP375	VIP375CH	VIPROLA
Forte	VIP375	VIP375CH	VIPROLA
Fizz	VIP375	VIP375CH	VIPROLA
Ovetto 50	VIP375	VIP375CH	VIPROLA
Nitro	VIP375	VIP375CH	VIPROLA
Nitro 50	VIP375	VIP375CH	VIPROLA
Nitro/ Ovetto 100cc	VIP380		VIPROLA
MachG	VIP375	VIP375CH	VIPROLA
Match	VIP375	VIP375CH	VIPROLA
Stunt	VIP375	VIP375CH	VIPROLA
<b>MZ</b>			
Moskito RX 50	VIP375	VIP375CH	VIPROLA
<b>PIAGGIO</b>			
Typhoon 50	VIP040	VIP040CH	VIPROLC
C22 (NRG50)	VIP040	VIP040CH	VIPROLE
Liberty 50	VIP040	VIP040CH	VIPROLC
NRG/mc2/mc3	VIP040	VIP040CH	VIPROLC
NTT	VIP040	VIP040CH	VIPROLC
Extreme	VIP040	VIP040CH	VIPROLC
Storm	VIP040	VIP040CH	VIPROLC
Free	VIP040	VIP040CH	VIPROLC
Zip 50 2T	VIP040	VIP040CH	VIPROLC
Zip Fast Rider	VIP040	VIP040CH	VIPROLE
Zip 25km/h	VIP040	VIP040CH	VIPROLE
Diesis 50	VIP040	VIP040CH	VIPROLC
Fly 50 2T	VIP040	VIP040CH	VIPROLC
Quartz	VIP040	VIP040CH	VIPROLC
TPH50	VIP040	VIP040CH	VIPROLC

PUCH	SILENCER	CLUTCH ROLLERS
Stalker	VIP040	VIP040CH VIPROLB

\* Not 94-00 Minarelli engine



## Viper Scooter Silencers cont...

MODEL	SMOKED SILENCER	CHROME SILENCER	CLUTCH ROLLERS
-------	-----------------	-----------------	----------------

### PEUGEOT

Buxy >98	VIP242	VIP242CH	VIPROLB
Zenith >98	VIP242	VIP242CH	VIPROLB
Squab 50	VIP242	VIP242CH	VIPROLB
Speedfight 1/ 2 50	VIP242	VIP242CH	VIPROLB
Vivacity 50	VIP242	VIP242CH	VIPROLB
Trekker 50	VIP242	VIP242CH	VIPROLB
Elyseo 50	VIP242	VIP242CH	VIPROLB
Looxor 50	VIP242	VIP242CH	VIPROLB
Elystar 50	VIP242	VIP242CH	n/a
TKR	VIP242	VIP242CH	n/a

### RIEJU

First	VIP375	VIP375CH	VIPROLA
Windy 50	VIP375	VIP375CH	VIPROLA
F-10 50	VIP375	VIP375CH	VIPROLA

### SIAMOTO

Top racing 50	VIP375	VIP375CH	VIPROLA
Birdie	VIP375	VIP375CH	VIPROLA
Mat 50	VIP375	VIP375CH	VIPROLA

### SMC

NDF / NMF / NGF / SAF 50cc 95>	VIP375	VIP375CH	VIPROLA
--------------------------------	--------	----------	---------

### SUZUKI

Katana AY50	VIP379	VIP379CH	VIPROLD
Zillion 50	VIP379	VIP379CH	VIPROLD
Estilete	VIP379	VIP379CH	VIPROLD

MODEL	SMOKED SILENCER	CHROME SILENCER	CLUTCH ROLLERS
-------	-----------------	-----------------	----------------

### TNG

LS	VIP375	VIP375CH	VIPROLA
SS	VIP375	VIP375CH	VIPROLA
Venice	VIP375	VIP375CH	VIPROLA

### VENTO

Triton GT5	VIP375	VIP375CH	VIPROLA
Triton LI 2T	VIP375	VIP375CH	VIPROLA
Triton r4	VIP375	VIP375CH	VIPROLA
Zip R3i	VIP375	VIP375CH	VIPROLA

### YAMAHA

Jog	VIP375	VIP375CH	VIPROLA
Axis 50	VIP375	VIP375CH	VIPROLA
Jog RR	VIP375	VIP375CH	VIPROLA
Breeze	VIP375	VIP375CH	VIPROLA
Zest 50-90	VIP375	VIP375CH	VIPROLA
Neo's 50	VIP375	VIP375CH	VIPROLA
Aerox	VIP375	VIP375CH	VIPROLA
Neo's 100	VIP380		VIPROLA
BW's 100	VIP380		VIPROLA
Aerox 100	VIP380		VIPROLA
Vino	VIP375	VIP375CH	VIPROLA
Why	VIP375	VIP375CH	VIPROLA
Zuma	VIP375	VIP375CH	VIPROLA
Bw's Next Generation	VIP380		VIPROLA
Jog 90	VIP380		VIPROLA

## Exhaust Gaskets

Avoid sales of illegal and harmful asbestos type with our asbestos free formula. Pack of 10.

Order Code	Outer Diameter	Order Code	Outer Diameter
EXG26	26mm	EXG44	44mm
EXG28	28mm	EXG45	45mm
EXG30	30mm	EXG46	46mm
EXG33	33mm	EXG47	47mm
EXG35	35mm	EXG48	48mm
EXG36	36mm	EXG49	49mm
EXG38	38mm	EXG51	51mm
EXG39	39mm	EXG53	53mm
EXG40	40mm	EXG54	54mm
EXG41	41mm	EXG55	55mm
EXG42	42mm	EXG56	56mm
EXG43	43mm	EXG62	62mm



## Replacement Silencers

OEM equivalent replacement silencers at a fraction of the cost.

Order Code	Model
HONDA	
EXHVIS	VISION
EXHC90CUB	C90 CUB
EXHANF125	ANF125 Innova

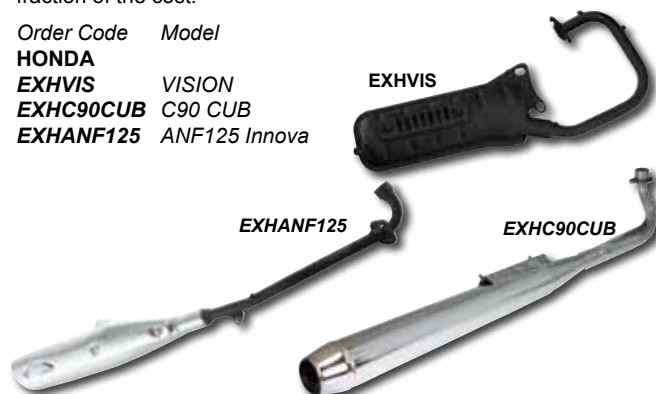

## Clutch Rollers

### DON'T FORGET TO ORDER CLUTCH ROLLERS!

Viper Scooter Silencers are supplied WITHOUT clutch rollers. It is recommended that new rollers are fitted at the same time as the Viper exhaust silencer being fitted. Full details of the clutch roller range is detailed below, check the application chart on this page for the correct rollers to use for each scooter model.

NB: The rollers compatibility detailed here is based on the scooter's rider weighing 75kgs / 12 stone or less.

Order Code	Specification
VIPROLA	15x12 4.75g
VIPROLB	16x13 6.5g
VIPROLC	19x15 4.5g
VIPROLD	17x12 5.5g
VIPROLE	19x15.5 4.5g

6 pieces per pack

## Silencer Gaskets

Bespoke replacement exhaust gaskets for Viper scooter silencers. Model fitment as shown below.

Order Code	Fits
VIPGSKA	VIP375, VIP040, VIP379, VIP380
VIPGSKB	VIP242



# Scooter & Moped Mirrors

Model	Year	Left Mirror Order code	Right Mirror Order code	Pair Order code
<b>Aprilia</b>				
Amico 50		MRASR50L	MRASR50R	#
Gulliver 50	97>	MRASR50L	MRASR50R	#
RS50	97>	MRARSVL	MRARSVR	#
SR50		MRASR50L	MRASR50R	#
SR50 / Factory		MRA002L	MRA002R	#
Tuono 50		MRA001L	MRA001R	#
Leonardo 125	>99	MRASR50L	MRASR50R	#
RS125	97>	MRARSVL	MRARSVR	#
SR125		MRASR50L	MRASR50R	#
Tuono 125		MRA001L	MRA001R	#
Leonardo 250	>99	MRASR50L	MRASR50R	#

<b>GILERA</b>				
Runner 50		MRG001L	MRG001R	#
FX125		MRG001L	MRG001R	#
FXR180		MRG001L	MRG001R	#

<b>HONDA</b>				
Cub C50 / 70 / 90		#	#	MRU64531
ANF125 Innova	03>	MRH004L	MRH004R	#
ANF125 Innova		MRH003L	MRH003R	#
CB100N		MRHCBCXL	MRHCBCXR	#
CB125RS		MRHCB125RSL	MRHCB125RSR	#
CBR125R	03-09	MRH012L	MRH012R	#
CBR125R	11-12	MRH009L	MRH009R	#
CG125		MRHCBCXL	MRHCBCXR	#
CG125	04>	MRH004L	MRH004R	#
MBX125		MRHNS125L	MRHNS125R	#
NS125		MRHNS125L	MRHNS125R	#
PS125		MRH003L	MRH003R	#
PS125i		MRH004L	MRH004R	#
SH125i / 150i	05-08	MRH003L	MRH003R	#
Scoopy				
CB250N		MRHCBCXL	MRHCBCXR	#

<b>ITALJET</b>				
Jupiter 125 / 150 / 250		MRY002L	MRY002R	#
Millenium		MRASR50L	MRASR50R	#

<b>MBK</b>				
Booster		MRYNEOL	MRYNEOR	#
Ovetto		MRYNEOL	MRYNEOR	#
Sprint		MRYNEOL	MRYNEOR	#
Stunt		MRYNEOL	MRYNEOR	#
Flame		MRY010L	MRY010R	#
Cygnus 125R		MRY010L	MRY010R	#
Fizz 50		MRY010L	MRY010R	#
Nitro		MRYARXL	MRYARXR	#

Model	Year	Left Mirror Order code	Right Mirror Order code	Pair Order code
<b>PEUGEOT</b>				
Elyseo		MRP001L	MRP001R	#
Jet Force		MRP002L	MRP002R	#
Speedake		MRP001L	MRP001R	#
Speedfight	>98	MRP001L	MRP001R	#
Speedfight 50 / 100	98>	MRPSFIGHTL	MRPSFIGHTR	#
Speedfight 100		MRP001L	MRP001R	#
Speedfight 2		MRP002L	MRP002R	#
Trekker		MRPSFIGHTL	MRPSFIGHTR	#
Vivacity		MRPSFIGHTL	MRPSFIGHTR	#
Vivacity		MRP002L	MRP002R	#

<b>PIAGGIO / VESPA</b>				
ET2 50	>99	MRPET2L	MRPET2R	#
ET4	>00	MRPET2L	MRPET2R	#
ET2 / 4		MRV001L	MRV001R	#
Liberty		MRV002L	MRV002R	#
NRG		MRPNRGL	MRPNRGR	#
Zip		MRPZIPL	MRPZIPR	#

<b>SUZUKI</b>				
TS50X		MRS10TS50	MRS10TS50	#
TS50X		MRS8TS50	MRS8TS50	#
Burgman UH125 / 200		MRS005L	MRS005R	#
Epicuro 125/150	01>	MRS012L	MRS012R	#
RV125	07	MRS012L	MRS012R	#
TS125R / X		MRST125	MRST125	#
Van Van	03-05	MRS012L	MRS012R	#
VL125 / 250		MRS002D	MRS002D	#
Burgman AN250 / 400		MRS008L	MRS008R	#

<b>YAMAHA</b>				
Aerox YQ50		MRYARXL	MRYARXR	#
Booster		MRYNEOL	MRYNEOR	#
Bump		MRYNEOL	MRYNEOR	#
Jog		MRYNEOL	MRYNEOR	#
Neos		MRYNEOL	MRYNEOR	#
Next		MRYNEOL	MRYNEOR	#
Nitro 50 / 100		MRYARXL	MRYARXR	#
Ovelto		MRYNEOL	MRYNEOR	#
Spy 50		MRYNEOL	MRYNEOR	#
BW's 100		MRY014L	MRY014R	#
Cygnus 125R		MRY010L	MRY010R	#
Maxster 125 / 250		MRYMXSL	MRYMXSR	#
RD125LC		MRYRDL	MRYRDR	#
RD125LC		MRYXJL	MRYXJL	#
TZR125		MRYXJL	MRYXJL	#
TZR125 / 250		MRYTZRL	MRYTZRR	#
YBR125	05>	MRY004L	MRY004R	#



10mm  
**MRA001R**      *RIGHT*      **MRA002R**      *RIGHT*      **MRARSVR**      *RIGHT*      **MRASR50R**      *RIGHT*  
**MRA001L**      *LEFT*      **MRA002L**      *LEFT*      **MRARSVL**      *LEFT*      **MRASR50L**      *LEFT*



**MRG001R**      *RIGHT*      **MRH003R**      *RIGHT 8mm reverse thread*      **MRY004R**      *RIGHT*      **MRH009R**      *RIGHT*  
**MRG001L**      *LEFT*      **MRH003L**      *LEFT 8mm thread*      **MRY004L**      *LEFT*      **MRH009L**      *LEFT*

MotoGP  
 Exhausts  
 Screens  
 COMPUTER  
 Controls  
 Headlights  
 Indicators  
 Mirrors  
 Rear Lights  
 Lifts & Stands  
 Tools  
 Batteries & Chargers  
 Electrics  
 Chain  
 Servicing  
 Tyres & Tubes  
 Security  
 Bike Accs  
 Luggage  
 Rider Accs  
 Tank Pads  
 Extras  
 www.bikeit.com

# Scooter & Moped Mirrors cont...



**MRH012R** RIGHT  
**MRH012L** LEFT



**MRHCB125RSR** RIGHT  
**MRHCB125RSL** LEFT

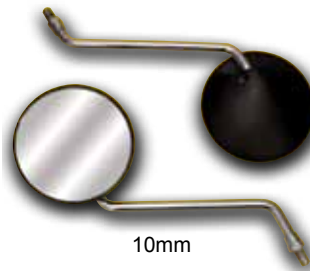

**MRHCBCXR** RIGHT  
**MRHCBCXL** LEFT

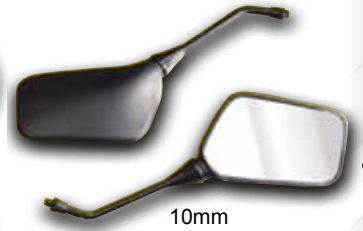

**MRHNS125R** RIGHT  
**MRHNS125L** LEFT



**MRP001R** RIGHT  
**MRP001L** LEFT



**MRP002R** RIGHT  
**MRP002L** LEFT



**MRPET2R** RIGHT  
**MRPET2L** LEFT



**MRPNRGR** RIGHT  
**MRPNRGL** LEFT



**MRPSFIGHTR** RIGHT  
**MRPSFIGHTL** LEFT



**MRPZIPR** RIGHT  
**MRPZIPL** LEFT

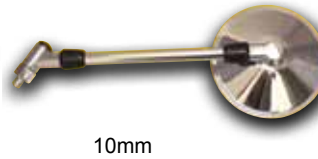

**MRS002D** LEFT or RIGHT



**MRS005R** RIGHT  
**MRS005L** LEFT

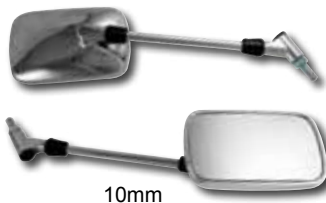

**MRS008R** RIGHT  
**MRS008L** LEFT



**MRS012R** RIGHT  
**MRS012L** LEFT



**MRS8TS50 (8mm)** LEFT or RIGHT  
**MRS10TS50 (10mm)** LEFT or RIGHT

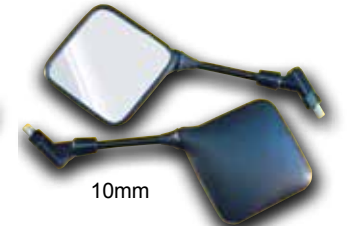

**MRSTS125** LEFT or RIGHT



**MRUSCOOTR** RIGHT  
**MRUSCOOTL** LEFT



**MRV001R** RIGHT  
**MRV001L** LEFT



**MRV002R** RIGHT  
**MRV002L** LEFT



**MRV004R** RIGHT  
**MRV004L** LEFT

Motocp  
Exhausts  
Screens  
Computer  
Controls  
Headlights  
Indicators  
Mirrors  
Rear Lights  
Lifts & Stands  
Tools  
Batteries & Chargers  
Electrics  
Chain  
Servicing  
Tyres & Tubes  
Security  
Bike Accs  
Luggage  
Rider Accs  
Tank Pads  
Extras



## Sam Browne Reflective Belt

**NEW**

The timeless and original Sam Browne style safety belt. Features crystalline reflective tape mounted on a robust nylon webbing strap, oversize buckle for ease of use with gloved hands, fully adjustable on the waist and shoulder.

Order Code: **REFBWN**



## Reflective Brace

High visibility brace, made from crystalline reflective tape, as used by British police and emergency services. Features waist belt with 2 shoulder straps, fully adjustable to fit all sizes! Waist and chest bands use large size click buckles, easy to use even with gloves on.

Order Code: **REFBRC**



## Reflective Over Jacket

A superior high visibility product, the 3/4 length sleeves offer additional safety and visibility, especially from the side and in heavy traffic. Features white reflective crystalline tape as used by the British police and emergency services.

Features:

- Generous cut
  - Zip front
  - Hi-Vis reflective crystalline tape
  - 3/4 Length sleeves
  - Lightweight - fits over existing clothes
- One size fits all.

Order Code: **REFJACK**



## Reflective Bib Vest

High visibility bib-vest for increased safety. Bright colours and reflective tape helps other road users see riders both day and night.

Features:

- Generous cut for comfort
  - Strong zip fastening front
  - EN471/EN340 "Hi-Vis" tape
- One size fits all.

Order Code	Description
<b>REFVEST</b>	Yellow
<b>REFVORG</b>	Orange



## Urban Hi-Vis Gilet

A robust premium hi-vis garment for wearing over motorcycle jackets. Manufactured from tough Oxford material with mesh lining.

Hi-vis yellow colour with reflective trim for increased on-road visibility.

Features lower back zip-pocket with overflap, waist pockets and zipped chest-pocket. Fully adjustable 'floating' sides for optimum fitting.

Order Code	Size
<b>REFGLT11</b>	Medium
<b>REFGLT12</b>	Large / XL



## Commute Hi-Vis

A hard-wearing hi-visibility gilet for wearing over motorcycle jackets.

Manufactured from durable nylon with inner mesh lining.

Jumbo front zip.

Highly visible yellow colour with reflective piping and trim detail.

Stretch side panels ensure comfort fit without baggy feeling.

2 internal pockets.

Order Code	Size
<b>REFGLT14</b>	Small / Medium
<b>REFGLT15</b>	Large
<b>REFGLT16</b>	XL / 2XL



## Mudflaps

Easy to install mudflaps fit to fenders or number plates  
Available in plain black or L-Plate design

Order Code	Description
<b>MUD011</b>	Black
<b>MUD015</b>	L-Plate

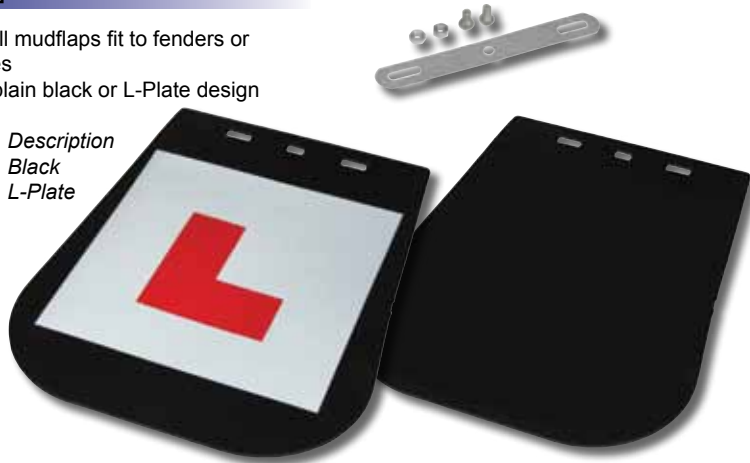

## ABS Top Box

ABS luggage top boxes.

Universal fitting bracket will fit most carrier racks.

The top-box can be removed from fitting bracket when not in use, using the anti-tamper quick release mechanism activated securely from inside the box.

Spring-activated self-locking mechanism.

Reflective detail trim for increased safety.

Order Code	Description
<b>LUGBOX10</b>	24L Capacity
<b>LUGBOX11</b>	48L Capacity



## L Plates

Order Code	Description
<b>LPT01</b>	Self Adhesive (pack of 10)
<b>LPT02</b>	Tie-On (4 hole) (pack of 10)
<b>LPT03</b>	Rigid 2mm thick (pack of 10)
<b>LPT04</b>	Rigid 2mm thick with Fixing brackets (pack of 10)



## Plastic Tax Disc Holders

This original budget plastic holder features simple clip-in window closure. Supplied on a card of 10 pieces.

Order Code	Description
<b>TDHPBLK</b>	Black (per 10)
<b>TDHPW</b>	White (per 10)



## Road Gloves

TEXTILE WINTER THERMAL

- Waterproof textile road glove
- Reinforced leather palm section
- Reflective piping
- Webbing tab-pull adjuster across wrist
- High cuff for wind protection
- Thermal lining

Order Code	Sizes
<b>GLVRD18S</b>	Small
<b>GLVRD18M</b>	Medium
<b>GLVRD18L</b>	Large
<b>GLVRD18XL</b>	XL
<b>GLVRD18XXL</b>	2XL



## "URBAN" Scooter Apron

- Provides wind and rain protection for rider
- Simple waist fitment by adjustable webbing belt and buckle
- Apron is tailor-fitted to rest over legs when riding
- Thick and durable oxford outer layer
- Inner fleece lining for maximum warmth
- 2 side pockets with reflective piping
- Supplied with storage bag

Order Code: **RCOLEG02**



## "CHASER" Scooter Apron

- Provides wind and rain protection for rider
- Connects to scooter by webbing straps and velcro closures
- Bib fitment for additional rider protection
- Apron is designed to attach to scooter, creating protective cover for legs
- Thick and durable oxford outer layer
- Inner fleece lining for maximum warmth
- Folds flat into internal storage compartment with shoulder strap when not in use
- Supplied with storage bag

Order Code: **RCOLEG03**



Motocp  
Exhausts  
Screens  
Computer  
Controls  
Headlights  
Indicators  
Mirrors  
Rear Lights  
Lifts & Stands  
Tools  
Batteries & Chargers  
Electrics  
Chain  
Servicing  
Tyres & Tubes  
Security  
Bike Accs  
Luggage  
Rider Accs  
Tank Pads  
Extras



MotorGP  
 Exhausts  
 Screens  
 Commuter  
 Controls  
 Headlights  
 Indicators  
 Mirrors  
 Rear Lights  
 Lifts & Stands  
 Tools  
 Batteries & Chargers  
 Electrics  
 Chain  
 Servicing  
 Tyres & Tubes  
 Security  
 Bike Accs  
 Luggage  
 Rider Accs  
 Tank Pads  
 Extras  
 www.bikeit.co.uk

## Reflector Kits

- 22mm x 94mm self-adhesive reflector kits
  - Available in red and amber
  - Sold in pairs
- E-marked
- |                   |               |
|-------------------|---------------|
| <i>Order Code</i> | <i>Colour</i> |
| <b>REF006</b>     | Red           |
| <b>REF003</b>     | Amber         |

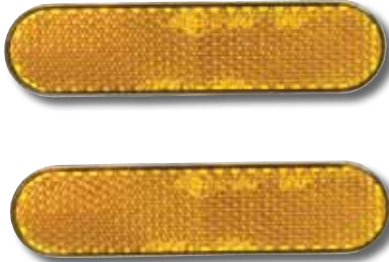

## Stick On Number Plate Reflectors

Self adhesive.  
20mm diameter.

<i>Order Code</i>	<i>Description</i>
<b>REF009</b>	2 pc pack
<b>REF012</b>	50pc pack



## Reflective Sticker Set

- Self-adhesive stickers
- Place on motorcycles and vehicles for increased visibility and safety
- 20pcs round sticker
- 4pcs rectangle sticker

Before fitting ensure area where sticker is to be placed is clean, dry and free from grease.

*Order Code: REFSTK7*

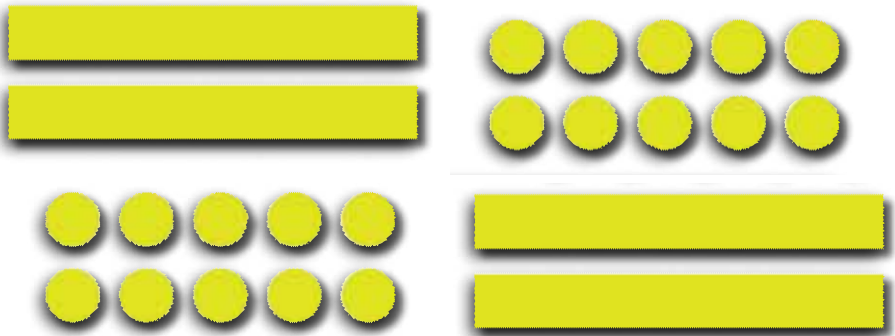

## Deluxe Polyester Ventilated Raincovers

- Rip-Stop polyester construction with water repellent coating
- Shape to fit styling
- Aluminium lower section to prevent exhaust melt
- Anti-condensation ventilators
- Fitted elasticated bottom seam
- Tie-down grommets and "under bike" securing elastic
- Storage bag



<i>Order Code</i>	<i>Description</i>
<b>RCODELM</b>	Medium protective cover up to 500cc
<b>RCODELL</b>	Large protective cover up to 750/1100cc
<b>RCODELXL</b>	X.Large protective cover 1200cc plus

## Heavy Duty PVC Raincovers

- P.V.C. construction
- Shape to fit styling
- Storage bag



<i>Order Code</i>	<i>Description</i>
<b>RCOM</b>	Medium rain cover up to 500cc
<b>RCOL</b>	Large rain cover up to 750/1100cc
<b>RCOXXL</b>	X.Large rain cover 1200cc plus

## Bar Muffs

Thermal fleece lined bar muffs, protects rider's hands from wind and rain. Bar muffs slide over grips and controls, and are secured by adjustable webbing straps and buckles.



*Order Code: GRPMUFF*



## Boxer Bar Muffs

- Protects rider's hands from wind and rain
- 3 layer neoprene construction provides optimum protection
- Unique universal fitting, grips and levers locate through the bar muff
- Contoured fit, increased comfort
- Reflective print safety feature
- Optional mirror cords

*Order Code: GRPBOX*







RACING PRODUCT

# TOP PERFORMANCE & TOP CONTROL

## TITAX SUPERBIKE CLUTCH AND BRAKE LEVERS

Levers are the HIGHEST QUALITY products available. No.1 on the market. Allowing you to manage your bike as never before. The SMOOTHEST ACTION EVER!

AVAILABLE IN THIS COLOR:

 **BLACK LEVER**  
**GOLD ADJUSTER**

 **SILVER LEVER**  
**BLACK ADJUSTER**

 **GOLD LEVER**  
**BLACK ADJUSTER**

 **BLUE LEVER**  
**GOLD ADJUSTER**



 **TÜVRheinland**  
Precisely Right.



### CHAMPIONS VERIFIED

TITAX Products are highly requested by many top racing teams in World Superbike Championships. Let's mention just a few of them:

STIGGY RACING - Leon Haslam  
HONDA PARKAGLAR - Eugene Laverty  
YZF YAMAHA - Tata Prodita  
MS RACING - Matej Smrz, Ondra Jezek,  
Barry Liam Burrell  
and many others...



Used in  
WSBK, WSS, World Endurance, IDM, BSB, etc.

 [www.TITAX.COM](http://www.TITAX.COM)

## Titax Levers

MODEL	YEAR	CLUTCH LONG BLACK	CLUTCH LONG SILVER	CLUTCH LONG GOLD	CLUTCH LONG BLUE	FOLDING CLUTCH LONG SILVER
<b>BREMBO</b>						
BREMBO 19*16 / 16*16		#	#	#	#	TTXLS31F
BREMBO 19*18/ 16*18		#	#	#	#	TTXLS32F
BREMBO 19*20		#	#	#	#	TTXLS33F
<b>APRILIA</b>						
RS 125 / 2T	06-11	TTXLBK61	TTXLS61	TTXLG61	#	#
Scarabeo 125 / 150 / 200	99-03	TTXLBK47	TTXLS47	#	#	#
Atlantic 500 Sprint	01-04	TTXLBK47	TTXLS47	#	#	#
Scarabeo 500	03-06	TTXLBK47	TTXLS47	#	#	#
Shiver 750	08-12	TTXLBK48	TTXLS48	TTXLG48	#	#
Shiver 750 GT,ABS	09-12	TTXLBK48	TTXLS48	TTXLG48	#	#
Dorsoduro 750	08-12	TTXLBK48	TTXLS48	TTXLG48	#	#
Dorsoduro 750 Factory	10-12	TTXLBK48	TTXLS48	TTXLG48	#	#
Dorsoduro 750 Factory ABS	10-12	TTXLBK13	TTXLS13	TTXLG13	#	#
Mana 850	08-10	N/A	N/A	N/A	#	#
Mana 850 GT, ABS	09-10	N/A	N/A	NA	#	#
RSV/R 1000 Mille	99-03	TTXLBK13	TTXLS13	TTXLG13	#	TTXLS13F
TUONO 1000	02-10	TTXLBK13	TTXLS13	TTXLG13	#	TTXLS13F
TUONO V4	10-12	TTXLBK21	TTXLS21	TTXLG21	#	#
Falco/SL 1000	00-04	TTXLBK13	TTXLS13	TTXLG13	#	TTXLS13F
Caponord/EVT 1000	02-07	TTXLBK13	TTXLS13	TTXLG13	#	TTXLS13F
RSV Mille/R	04-08	TTXLBK25R	TTXLS25R	TTXLG25R	#	TTXLS25RF
RSV4 Factory	09-12	TTXLBK21	TTXLS21	TTXLG21	#	#
RSV4 R	10-12	TTXLBK21	TTXLS21	TTXLG21	#	#
Dorsoduro 1200	11-12	TTXLBK13	TTXLS13	TTXLG13	#	TTXLS13F
<b>BIMOTA</b>						
DB5R	08-11	TTXLBK13	TTXLS13	TTXLG13	#	TTXLS13F
DB5S	06-11	TTXLBK13	TTXLS13	TTXLG13	#	TTXLS13F
DB6 Delirio	06-11	TTXLBK13	TTXLS13	TTXLG13	#	TTXLS13F
DB7	08-11	TTXLBK25R	TTXLS25R	TTXLG25R	#	TTXLS25RF
DB8	10-11	TTXLBK25R	TTXLS25R	TTXLG25R	#	TTXLS25RF
<b>BENELLI</b>						
TRE-K	all	TTXLBK36	TTXLS36	#	#	#
TRE-K Amazonas	all	TTXLBK36	TTXLS36	#	#	#
TNT	all	TTXLBK36	TTXLS36	#	#	#
TNT Titanium	all	TTXLBK36	TTXLS36	#	#	#
TNT Sport Evo	all	TTXLBK36	TTXLS36	#	#	#
<b>BMW</b>						
HP 2 Enduro	all	TTXLBK37	TTXLS37	TTXLG37	#	#
K1200GT	07>	TTXLBK37	TTXLS37	TTXLG37	#	#
K1200S	all	TTXLBK37	TTXLS37	TTXLG37	#	#
K1200R	all	TTXLBK37	TTXLS37	TTXLG37	#	#
K1200R Sport	all	TTXLBK37	TTXLS37	TTXLG37	#	#
R1200S	all	TTXLBK37	TTXLS37	TTXLG37	#	#
R1200R	all	TTXLBK37	TTXLS37	TTXLG37	#	#
R1200ST	all	TTXLBK37	TTXLS37	TTXLG37	#	#
R1200GS	all	TTXLBK37	TTXLS37	TTXLG37	#	#
R1200GS Adventure	06-08	TTXLBK37	TTXLS37	TTXLG37	#	#
S1000 RR	09-12	TTXLBK59	TTXLS59	#	TTXLBL59	TTXLS59F
K 1300 S/R/GT	09>	TTXLBK37	TTXLS37	TTXLG37	#	#
<b>BUELL</b>						
S1, M2, X1	all	TTXLBK11	TTXLS11	#	#	#
XB9	03-08	TTXLBK11	TTXLS11	#	#	#
XB12	04-08	TTXLBK11	TTXLS11	#	#	#
XB1125 R/RC	08	TTXLBK24	TTXLS24	TTXLG24	#	#
<b>DUCATI</b>						
Monster	>03	TTXLBK12	TTXLS12	TTXLG12	#	#



## Titax Levers cont...

BRAKE LONG BLACK	BRAKE LONG SILVER	BRAKE LONG GOLD	BRAKE LONG BLUE	FOLDING BRAKE LONG SILVER
------------------	-------------------	-----------------	-----------------	---------------------------



Titax superbike CLUTCH and BRAKE levers. Quality CNC machined levers with unique click adjuster.

All order codes shown are for LONG lever type.

To order SHORT levers, just add the letter 'A' behind the order code.



#	#	#	#	TTXRS25F
#	#	#	#	TTXRS26F
#	#	#	#	TTXRS27F
TTXRBK53	TTXRS53	TTXRG53	#	#
TTXRBK38	TTXRS38	#	#	#
TTXRBK38	TTXRS38	#	#	#
TTXRBK38	TTXRS38	#	#	#
TTXRBK40	TTXRS40	TTXRG40	#	#
TTXRBK40	TTXRS40	TTXRG40	#	#
TTXRBK40	TTXRS40	TTXRG40	#	#
TTXRBK40	TTXRS40	TTXRG40	#	#
TTXRBK40	TTXRS40	TTXRG40	#	#
TTXRBK40	TTXRS40	TTXRG40	#	#
TTXRBK13	TTXRS13	TTXRG13	#	#
TTXRBK40	TTXRS40	TTXRG40	#	#
TTXRBK40	TTXRS40	TTXRG40	#	#
TTXRBK13	TTXRS13	TTXRG13	#	TTXRS13F
TTXRBK23R	TTXRS23R	TTXRG23R	#	TTXRS13F
TTXRBK23R	TTXRS23R	TTXRG23R	#	#
TTXRBK13	TTXRS13	TTXRG13	#	TTXRS13F
TTXRBK13	TTXRS13	TTXRG13	#	TTXRS13F
TTXRBK23R	TTXRS23R	TTXRG23R	#	TTXRS23RF
TTXRBK23R	TTXRS23R	TTXRG23R	#	#
TTXRBK23R	TTXRS23R	TTXRG23R	#	#
TTXRBK13	TTXRS13	TTXRG13	#	TTXRS13F
TTXRBK13	TTXRS13	TTXRG13	#	TTXRS13F
TTXRBK13	TTXRS13	TTXRG13	#	TTXRS13F
TTXRBK23R	TTXRS23R	TTXRG23R	#	TTXRS23RF
TTXRBK23R	TTXRS23R	TTXRG23R	#	TTXRS23RF
TTXRBK22	TTXRS22	#	#	#
TTXRBK22	TTXRS22	#	#	#
TTXRBK22	TTXRS22	#	#	#
TTXRBK22	TTXRS22	#	#	#
TTXRBK22	TTXRS22	#	#	#
TTXRBK29	TTXRS29	TTXRG29	#	#
TTXRBK29	TTXRS29	TTXRG29	#	#
TTXRBK29	TTXRS29	TTXRG29	#	#
TTXRBK29	TTXRS29	TTXRG29	#	#
TTXRBK29	TTXRS29	TTXRG29	#	#
TTXRBK29	TTXRS29	TTXRG29	#	#
TTXRBK29	TTXRS29	TTXRG29	#	#
TTXRBK29	TTXRS29	TTXRG29	#	#
TTXRBK29	TTXRS29	TTXRG29	#	#
TTXRBK29	TTXRS29	TTXRG29	#	#
TTXRBK18	TTXRS18	#	TTXRBL18	TTXRS18F
TTXRBK29	TTXRS29	TTXRG29	#	#
TTXRBK17	TTXRS17	#	#	#
TTXRBK11	TTXRS11	#	#	#
TTXRBK11	TTXRS11	#	#	#
TTXRBK17	TTXRS17	TTXRG17	#	#
TTXRBK12	TTXRS12	TTXRG12	#	#

Motorcycle  
Exhausts  
Screens  
Commuter  
Controls  
Headlights  
Indicators  
Mirrors  
Rear Lights  
Lifts & Stands  
Tools  
Batteries & Chargers  
Electrics  
Chain  
Servicing  
Tyres & Tubes  
Security  
Bike Accs  
Luggage  
Rider Accs  
Tank Pads  
Extras



## Titax Levers cont...

MODEL	YEAR	CLUTCH	CLUTCH	CLUTCH	CLUTCH	FOLDING CLUTCH
		LONG	LONG	LONG	LONG	LONG
		BLACK	SILVER	GOLD	BLUE	SILVER

### DUCATI cont...

Monster ST2	97-03	TTXLBK12	TTXLS12	TTXLG12	#	#
Monster S2RC	06-08	TTXLBK13	TTXLS13	TTXLG13	#	TTXLS13F
Monster S4/S4R	01-06	TTXLBK13	TTXLS13	TTXLG13	#	TTXLS13F
Monster S4/S4R	07>	TTXLBK25R	TTXLS25R	TTXLG25R	#	TTXLS25RF
Monster 620	06	TTXLBK12	TTXLS12	TTXLG12	#	#
Monster 695	07	TTXLBK12	TTXLS12	TTXLG12	#	#
Monster 696	08-12	TTXLBK60	TTXLS60	TTXLG60	#	#
Monster 796	10-12	TTXLBK60	TTXLS60	TTXLG60	#	#
Multistrada 620	05-06	TTXLBK13	TTXLS13	TTXLG13	#	TTXLS13F
Monster 1100	09-10	TTXLBK25R	TTXLS25R	TTXLG25R	#	TTXLS25RF
748/750SS	99-04	TTXLBK13	TTXLS13	TTXLG13	#	TTXLS13F
748 / 916	>98	TTXLBK12	TTXLS12	TTXLG12	#	#
749 S/R	03-07	TTXLBK25R	TTXLS25R	TTXLG25R	#	TTXLS25RF
750/900SS	91-98	TTXLBK12	TTXLS12	TTXLG12	#	#
M900/M1000	00-05	TTXLBK13	TTXLS13	TTXLG13	#	TTXLS13F
900S / 1000S	98-06	TTXLBK13	TTXLS13	TTXLG13	#	TTXLS13F
996/998B/S/R	99-03	TTXLBK13	TTXLS13	TTXLG13	#	TTXLS13F
999 S/R	03-07	TTXLBK25R	TTXLS25R	TTXLG25R	#	TTXLS25RF
Multistrada 1000	04-06	TTXLBK13	TTXLS13	TTXLG13	#	TTXLS13F
MTS 1000 SDS/DS	04-06	TTXLBK13	TTXLS13	TTXLG13	#	TTXLS13F
MTS 1000 S	07	TTXLBK13	TTXLS13	TTXLG13	#	TTXLS13F
ST4/S/ABS	04-06	TTXLBK13	TTXLS13	TTXLG13	#	TTXLS13F
ST3/S/ABS	03-07	TTXLBK13	TTXLS13	TTXLG13	#	TTXLS13F
Sport 1000	06-08	TTXLBK13	TTXLS13	TTXLG13	#	TTXLS13F
GT 1000 / S	06-10	TTXLBK13	TTXLS13	TTXLG13	#	TTXLS13F
Hypermotard 796	10-12	TTXLBK60A	TTXLS60A	TTXLG60A	#	#
Hypermotard 1100	09-10	TTXLBK25RA	TTXLS25RA	TTXLG25RA	#	TTXLS25RFA
Hypermotard 1100 Evo	10-12	TTXLBK25RA	TTXLS25RA	TTXLG25RA	#	TTXLS25RFA
848	09-12	TTXLBK25R	TTXLS25R	TTXLG25R	#	TTXLS25RF
Streetfighter S	09-12	TTXLBK25R	TTXLS25R	TTXLG25R	#	TTXLS25RF
Streetfighter 848	12	TTXLBK25R	TTXLS25R	TTXLG25R	#	TTXLS25RF
Paul Smart LE	06	TTXLBK13	TTXLS13	TTXLG13	#	TTXLS13F
1098	07-08	TTXLBK25R	TTXLS25R	TTXLG25R	#	TTXLS25RF
1198 / S	09-11	TTXLBK25R	TTXLS25R	TTXLG25R	#	TTXLS25RF
Multistrada 1100	07-09	TTXLBK13	TTXLS13	TTXLG13	#	TTXLS13F
Multistrada 1200	10-12	TTXLBK25R	TTXLS25R	TTXLG25R	#	TTXLS25RF
Monster 1100 EVO	11-12	TTXLBK25RA	TTXLS25RA	TTXLG25RA	#	TTXLS25RFA
Hypermotard 1100 EVO SP	11-12	TTXLBK25RA	TTXLS25RA	TTXLG25RA	#	TTXLS25RFA
Diavel	11-12	TTXLBK25R	TTXLS25R	TTXLG25R	#	TTXLS25RFA

### HONDA

CBF 500	04-06	TTXLBK49	TTXLS49	#	#	#
CB600 HORNET	98-06	TTXLBK14	TTXLS14	TTXLG14	#	#
CB600 F HORNET	07-12	TTXLBK62	TTXLS62	#	#	#
CBF 600	04-06	TTXLBK14	TTXLS14	TTXLG14	#	#
CBF 600	07-10	TTXLBK41	TTXLS41	TTXLG41	#	#
CBR600/F2/F3/F4/F4i	87-07	TTXLBK14	TTXLS14	TTXLG14	#	#
CBR600F	07-12	TTXLBK41	TTXLS41	TTXLG41	#	#
CBR600RR	03-06	TTXLBK15	TTXLS15	TTXLG15	#	TTXLS15F
CBR600RR	07-12	TTXLBK15	TTXLS15	TTXLG15	#	TTXLS15F
Deauville	06-07	TTXLBK14	TTXLS14	TTXLG14	#	#
NC 700 S/X	12	TTXLBK14	TTXLS14	TTXLG14	#	#
Transalp 700	08-12	TTXLBK45	#	#	#	#
Magna VF 750C	02>	TTXLBK14	TTXLS14	TTXLG14	#	#
VFR 750	91-97	TTXLBK30R	TTXLS30R	TTXLG30R	#	#
Crossrunner 800	12	TTXLBK16	TTXLS16	TTXLG16	#	#
VFR 800	02-10	TTXLBK16	TTXLS16	TTXLG16	#	#
VFR 800	98-01	TTXLBK16	TTXLS16	TTXLG16	#	#
CB900 HORNET	02-07	TTXLBK14	TTXLS14	TTXLG14	#	#
CBR900RR	96-99	TTXLBK14	TTXLS14	TTXLG14	#	#
CBR929RR	00-01	TTXLBK14	TTXLS14	TTXLG14	#	#
CBR954RR	02-06	TTXLBK15	TTXLS15	TTXLG15	#	TTXLS15F

## Titax Levers cont...

BRAKE LONG BLACK	BRAKE LONG SILVER	BRAKE LONG GOLD	BRAKE LONG BLUE	FOLDING BRAKE LONG SILVER
------------------------	-------------------------	-----------------------	-----------------------	---------------------------------



Titax superbike CLUTCH and BRAKE levers. Quality CNC machined levers with unique click adjuster.

All order codes shown are for LONG lever type.

To order SHORT levers, just add the letter 'A' behind the order code.



TTXRBK12	TTXRS12	TTXRG12	#	#
TTXRBK13	TTXRS13	TTXRG13	#	TTXRS13F
TTXRBK13	TTXRS13	TTXRG13	#	TTXRS13F
TTXRBK23R	TTXRS23R	TTXRG23R	#	TTXRS23RF
TTXRBK12	TTXRS12	TTXRG12	#	#
TTXRBK12	TTXRS12	TTXRG12	#	#
TTXRBK12	TTXRS12	TTXRG12	#	#
TTXRBK12	TTXRS12	TTXRG12	#	#
TTXRBK13	TTXRS13	TTXRG13	#	TTXRS13F
TTXRBK23R	TTXRS23R	TTXRG23R	#	TTXRS23RF
TTXRBK13	TTXRS13	TTXRG13	#	TTXRS13F
TTXRBK12	TTXRS12	TTXRG12	#	#
TTXRBK23R	TTXRS23R	TTXRG23R	#	TTXRS23RF
TTXRBK12	TTXRS12	TTXRG12	#	#
TTXRBK13	TTXRS13	TTXRG13	#	TTXRS13F
TTXRBK13	TTXRS13	TTXRG13	#	TTXRS13F
TTXRBK13	TTXRS13	TTXRG13	#	TTXRS13F
TTXRBK23R	TTXRS23R	TTXRG23R	#	TTXRS23RF
TTXRBK13	TTXRS13	TTXRG13	#	TTXRS13F
TTXRBK13	TTXRS13	TTXRG13	#	TTXRS13F
TTXRBK13	TTXRS13	TTXRG13	#	TTXRS13F
TTXRBK13	TTXRS13	TTXRG13	#	TTXRS13F
TTXRBK13	TTXRS13	TTXRG13	#	TTXRS13F
TTXRBK13	TTXRS13	TTXRG13	#	TTXRS13F
TTXRBK12A	TTXRS12A	TTXRG12A	#	#
TTXRBK23RA	TTXRS23RA	TTXRG23RA	#	TTXRS23RFA
TTXRBK23RA	TTXRS23RA	TTXRG23RA	#	TTXRS23RFA
TTXRBK23R	TTXRS23R	TTXRG23R	#	TTXRS23RF
TTXRBK23R	TTXRS23R	TTXRG23R	#	TTXRS23RF
TTXRBK23R	TTXRS23R	TTXRG23R	#	TTXRS23RF
TTXRBK13	TTXRS13	TTXRG13	#	TTXRS13F
TTXRBK23R	TTXRS23R	TTXRG23R	#	TTXRS23RF
TTXRBK23R	TTXRS23R	TTXRG23R	#	TTXRS23RF
TTXRBK13	TTXRS13	TTXRG13	#	TTXRS13F
TTXRBK23R	TTXRS23R	TTXRG23R	#	TTXRS23RF
TTXRBK23RA	TTXRS23RA	TTXRG23RA	#	TTXRS23RFA
TTXRBK23RA	TTXRS23RA	TTXRG23RA	#	TTXRS23RFA
TTXRBK23R	TTXRS23R	TTXRG23R	#	TTXRS23RF
TTXRBK14	TTXRS14	#	#	#
TTXRBK14	TTXRS14	TTXRG14	#	#
TTXRBK14	TTXRS14	#	#	#
TTXRBK14	TTXRS14	TTXRG14	#	#
TTXRBK14	TTXRS14	TTXRG14	#	#
TTXRBK14	TTXRS14	TTXRG14	#	#
TTXRBK14	TTXRS14	TTXRG14	#	#
TTXRBK14	TTXRS14	TTXRG14	#	#
TTXRBK15	TTXRS15	TTXRG15	#	TTXRS15F
TTXRBK16	TTXRS16	TTXRG16	#	TTXRS16F
TTXRBK14	TTXRS14	TTXRG14	#	#
TTXRBK14	TTXRS14	TTXRG14	#	#
TTXRBK36	#	#	#	#
TTXRBK14	TTXRS14	TTXRG14	#	#
TTXRBK14	TTXRS14	TTXRG14	#	#
TTXRBK14	TTXRS14	TTXRG14	#	#
TTXRBK14	TTXRS14	TTXRG14	#	#
TTXRBK28	TTXRS28	TTXRG28	#	#
TTXRBK14	TTXRS14	TTXRG14	#	#
TTXRBK14	TTXRS14	TTXRG14	#	#
TTXRBK15	TTXRS15	TTXRG15	#	#
TTXRBK15	TTXRS15	TTXRG15	#	TTXRS15F

- MotorGP
- Exhausts
- Screens
- Commuter
- Controls
- Headlights
- Indicators
- Mirrors
- Rear Lights
- Lifts & Stands
- Tools
- Batteries & Chargers
- Electrics
- Chain
- Servicing
- Tyres & Tubes
- Security
- Bike Accs
- Luggage
- Rider Accs
- Tank Pads
- Extras



## Titax Levers cont...

MODEL	YEAR	CLUTCH	CLUTCH	CLUTCH	CLUTCH	FOLDING CLUTCH
		LONG	LONG	LONG	LONG	LONG
		BLACK	SILVER	GOLD	BLUE	SILVER

### HONDA cont...

CBF 1000	06-09	TTXLBK30R	TTXLS30R	TTXLG30R	#	#
CB1000R	08-12	TTXLBK16	TTXLS16	TTXLG16	#	#
CBR1000RR	04-07	TTXLBK16	TTXLS16	TTXLG16	#	TTXLS16F
CBR1000RR	08-12	TTXLBK15	TTXLS15	TTXLG15	#	TTXLS15F
VTR 1000F	98-05	TTXLBK30R	TTXLS30R	TTXLG30R	#	#
VTR 1000 SP1/SP2	00-06	TTXLBK16	TTXLS16	#	#	#
XL 1000 Varadero	99-12	TTXLBK55	TTXLS55	#	#	#
RC 51	01-06	TTXLBK16	TTXLS16	#	#	#
CBR 1100XX Blackbird	97-07	TTXLBK16	TTXLS16	TTXLG16	#	#
Crosstourer 1200	12	TTXLBK16	TTXLS16	TTXLG16	#	#
CB 1300 / ABS	03-09	TTXLBK16	TTXLS16	TTXLG16	#	#

### HYOSUNG

GT 650	06-07	TTXLBK28	TTXLS28	#	#	#
--------	-------	----------	---------	---	---	---

### KAWASAKI

Ninja 250R	08-12	TTXLBK56	TTXLS56	#	#	#
GPZ500	90-95	TTXLBK35	TTXLS35	TTXLG35	#	#
KLE500	91-97	TTXLBK35	TTXLS35	TTXLG35	#	#
ER-5	04-05	TTXLBK35	TTXLS35	TTXLG35	#	#
ER-6 F/N	06-11	TTXLBK35	TTXLS35	TTXLG35	#	#
ER-6 F/N	12	TTXLBK35	TTXLS35	TTXLG35	#	#
ZZR 600	93-02	TTXLBK35	TTXLS35	TTXLG35	#	#
ZX6R	95-99	TTXLBK35	TTXLS35	TTXLG35	#	#
ZX6	98-04	TTXLBK17	TTXLS17	TTXLG17	TTXLBL17	TTXLS17F
ZX6R	03	TTXLBK17	TTXLS17	TTXLG17	TTXLBL17	TTXLS17F
ZX6R 636	00-06	TTXLBK17	TTXLS17	TTXLG17	#	#
ZX6R	07-12	TTXLBK17	TTXLS17	TTXLG17	TTXLBL17	TTXLS17F
ZX6RR	03-04	TTXLBK17	TTXLS17	TTXLG17	TTXLBL17	TTXLS17F
Versys	06-12	TTXLBK35	TTXLS35	TTXLG35	#	#
ZR-7/S	99-03	TTXLBK35	TTXLS35	TTXLG35	#	#
ZX7R / RR	89-03	TTXLBK34R	TTXLS34R	TTXLG34R	#	#
Zephyr 750	91-97	TTXLBK35	TTXLS35	TTXLG35	#	#
Z 750	04-06	TTXLBK35	TTXLS35	TTXLG35	#	#
Z 750	07-12	TTXLBK17	TTXLS17	TTXLG17	#	#
Z 750 R	11-12	TTXLBK17	TTXLS17	TTXLG17	#	#
GPZ900R	90-93	TTXLBK34R	TTXLS34R	TTXLG34R	#	#
ZX9R	94-97	TTXLBK34R	TTXLS34R	TTXLG34R	#	#
ZX9R	98-99	TTXLBK35	TTXLS35	TTXLG35	#	#
ZX9R	00-03	TTXLBK17	TTXLS17	TTXLG17	TTXLBL17	TTXLS17F
ZX10	88-90	TTXLBK34R	TTXLS34R	TTXLG34R	#	#
ZX10RR	04-05	TTXLBK17	TTXLS17	TTXLG17	TTXLBL17	TTXLS17F
ZX10RR	06-12	TTXLBK17	TTXLS17	TTXLG17	TTXLBL17	TTXLS17F
Z 1000	03-06	TTXLBK17	TTXLS17	TTXLG17	TTXLBL17	TTXLS17F
Z 1000 / SX	07-12	TTXLBK17	TTXLS17	TTXLG17	TTXLBL17	TTXLS17F
GTR1000	92-06	TTXLBK34R	TTXLS34R	TTXLG34R	#	#
GPZ1000 / ABS	95-98	TTXLBK34R	TTXLS34R	TTXLG34R	#	#
Zephyr 1100	all	TTXLBK34R	TTXLS34R	TTXLG34R	#	#
ZZR 1100	90-02	TTXLBK34R	TTXLS34R	TTXLG34R	#	#
ZZR 1100	93-01	TTXLBK35	TTXLS35	TTXLG35	#	#
ZRX1100 / 1200	99-07	TTXLBK34R	TTXLS34R	TTXLG34R	#	#
ZZR 1200	02-05	TTXLBK34R	TTXLS34R	TTXLG34R	#	#
ZX12R	00-05	TTXLBK17	TTXLS17	TTXLG17	TTXLBL17	TTXLS17F
ZX14 / ZZR 1400	06-12	TTXLBK23	TTXLS23	TTXLG23	#	#
VN 1500 Classic & Tourer	98-03	TTXLBK34R	TTXLS34R	TTXLG34R	#	#
VN 1500 Mean Streak	02-03	TTXLBK34R	TTXLS34R	TTXLG34R	#	#
VN 1600 Classic & Tourer	03-05	TTXLBK34R	TTXLS34R	TTXLG34R	#	#
VN 1600 Mean Streak	04-06	TTXLBK34R	TTXLS34R	TTXLG34R	#	#

### KTM

690 Duke/SM-R	08	TTXLBK38R	TTXLS38R	#	#	#
990 Super Duke R	08	TTXLBK38R	TTXLS38R	#	#	#

## Titax Levers cont...



Titax superbike CLUTCH and BRAKE levers. Quality CNC machined levers with unique click adjuster.

All order codes shown are for LONG lever type.

To order SHORT levers, just add the letter 'A' behind the order code.



BRAKE LONG BLACK	BRAKE LONG SILVER	BRAKE LONG GOLD	BRAKE LONG BLUE	FOLDING BRAKE LONG SILVER
TTXRBK14	TTXRS14	TTXRG14	#	#
TTXRBK31R	TTXRS31R	TTXRG31R	#	#
TTXRBK16	TTXRS16	TTXRG16	#	TTXRS16F
TTXRBK16	TTXRS16	TTXRG16	#	TTXRS16F
TTXRBK14	TTXRS14	TTXRG14	#	#
TTXRBK15R	TTXRS15R	#	#	#
TTXRBK28	TTXRS28	#	#	#
TTXRBK15	TTXRS15	#	#	#
TTXRBK28	TTXRS28	TTXRG28	#	#
TTXRBK14	TTXRS14	TTXRG14	#	#
TTXRBK14	TTXRS14	TTXRG14	#	#
TTXRBK24	TTXRS24	#	#	#
TTXRBK46	TTXRS46	#	#	#
TTXRBK17	TTXRS17	TTXRG17	#	#
TTXRBK17	TTXRS17	TTXRG17	#	#
TTXRBK17	TTXRS17	TTXRG17	#	#
TTXRBK17	TTXRS17	TTXRG17	#	#
TTXRBK28	TTXRS28	TTXRG28	#	#
TTXRBK17	TTXRS17	TTXRG17	#	#
TTXRBK17	TTXRS17	TTXRG17	#	#
TTXRBK17	TTXRS17	TTXRG17	TTXRBL17	TTXRS17F
TTXRBK17	TTXRS17	TTXRG17	TTXRBL17	TTXRS17F
TTXRBK18R	TTXRS18R	TTXRG18R	#	#
TTXRBK21	TTXRS21	TTXRG21	TTXRBL21	TTXRS21F
TTXRBK17	TTXRS17	TTXRG17	TTXRBL17	TTXRS17F
TTXRBK17	TTXRS17	TTXRG17	#	#
TTXRBK17	TTXRS17	TTXRG17	#	#
TTXRBK17	TTXRS17	TTXRG17	#	#
TTXRBK17	TTXRS17	TTXRG17	#	#
TTXRBK17	TTXRS17	TTXRG17	#	#
TTXRBK17	TTXRS17	TTXRG17	#	#
TTXRBK11	TTXRS11	TTXRG11	#	#
TTXRBK11	TTXRS11	TTXRG11	#	#
TTXRBK17	TTXRS17	TTXRG17	#	#
TTXRBK17	TTXRS17	TTXRG17	#	#
TTXRBK17	TTXRS17	TTXRG17	#	#
TTXRBK17	TTXRS17	TTXRG17	TTXRBL17	TTXRS17F
TTXRBK17	TTXRS17	TTXRG17	#	#
TTXRBK17	TTXRS17	TTXRG17	TTXRBL17	TTXRS17F
TTXRBK21	TTXRS21	TTXRG21	TTXRBL21	TTXRS21F
TTXRBK17	TTXRS17	TTXRG17	TTXRBL17	TTXRS17F
TTXRBK21	TTXRS21	TTXRG21	TTXRBL21	TTXRS21F
TTXRBK17	TTXRS17	TTXRG17	#	#
TTXRBK17	TTXRS17	TTXRG17	#	#
TTXRBK17	TTXRS17	TTXRG17	#	#
TTXRBK17	TTXRS17	TTXRG17	#	#
TTXRBK17	TTXRS17	TTXRG17	#	#
TTXRBK17	TTXRS17	TTXRG17	#	#
TTXRBK17	TTXRS17	TTXRG17	#	#
TTXRBK17	TTXRS17	TTXRG17	TTXRBL17	TTXRS17F
TTXRBK21	TTXRS21	TTXRG21	#	#
TTXRBK17	TTXRS17	TTXRG17	#	#
TTXRBK17	TTXRS17	TTXRG17	#	#
TTXRBK17	TTXRS17	TTXRG17	#	#
TTXRBK17	TTXRS17	TTXRG17	#	#
TTXRBK17	TTXRS17	TTXRG17	#	#
TTXRBK17	TTXRS17	TTXRG17	#	#
TTXRBK17	TTXRS17	TTXRG17	#	#
TTXRBK17	TTXRS17	TTXRG17	#	#
TTXRBK17	TTXRS17	TTXRG17	#	#
TTXRBK23R	TTXRS23R	#	#	#
TTXRBK23R	TTXRS23R	#	#	#

- Motorcycle
- Exhausts
- Screens
- Commuter
- Controls
- Headlights
- Indicators
- Mirrors
- Rear Lights
- Lifts & Stands
- Tools
- Batteries & Chargers
- Electrics
- Chain
- Servicing
- Tyres & Tubes
- Security
- Bike Accs
- Luggage
- Rider Accs
- Tank Pads
- Extras

## Titax Levers cont...

MODEL	YEAR	CLUTCH	CLUTCH	CLUTCH	CLUTCH	FOLDING CLUTCH
		LONG BLACK	LONG SILVER	LONG GOLD	LONG BLUE	LONG SILVER
<b>KTM cont...</b>						
1190 RC8	08	TTXLBK38R	TTXLS38R	#	#	#
<b>MOTO GUZZI</b>						
Breva 1100	06-07	TTXLBK13	TTXLS13	#	#	#
Breva 1200	10-11	TTXLBK13	TTXLS13	#	#	#
Griso	06-09	TTXLBK13	TTXLS13	#	#	#
Griso 1200 / Griso 1200 V8	10-12	TTXLBK13	TTXLS13	#	#	#
V11	99-04	TTXLBK13	TTXLS13	#	#	#
Norge 1200 / Norge 1200 V8	08-12	TTXLBK13	TTXLS13	#	#	#
1200 Sport	08-09	TTXLBK13	TTXLS13	#	#	#
1200 Sport 8V	09-12	TTXLBK13	TTXLS13	#	#	#
Bellagio	07-10	TTXLBK13	TTXLS13	#	#	#
Bellagio Aquila Nera	11-12	TTXLBK13	TTXLS13	#	#	#
Stelvio 1200	08-12	TTXLBK13	TTXLS13	#	#	#
Stelvio 1200 NTX / V8	09-12	TTXLBK13	TTXLS13	#	#	#
<b>MV AGUSTA</b>						
Brutale 750	03-05	TTXLBK40	TTXLS40	TTXLG40	#	#
Brutale 910	05-08	TTXLBK40	TTXLS40	TTXLG40	#	#
Brutale 989 R	08-09	TTXLBK40	TTXLS40	TTXLG40	#	#
Brutale1078 RR	08-10	TTXLBK40	TTXLS40	TTXLG40	#	#
F4 750	99-03	TTXLBK40	TTXLS40	TTXLG40	#	#
F4 1000	04-07	TTXLBK40	TTXLS40	TTXLG40	#	#
F4R 312 R (1000)	07-09	TTXLBK40	TTXLS40	TTXLG40	#	#
F4 312 RR (1078)	07-10	TTXLBK40	TTXLS40	TTXLG40	#	#
<b>PIAGGIO</b>						
Beverly 125	06-08	TTXLBK46	TTXLS46	#	#	#
MP3 / Carnaby 125	07-08	TTXLBK46	TTXLS46	#	#	#
Carnaby 200	07-08	TTXLBK46	TTXLS46	#	#	#
X9 250	00-01	TTXLBK46	TTXLS46	#	#	#
MP3 / Beverly 250	06-08	TTXLBK46	TTXLS46	#	#	#
Beverly 400	06-08	TTXLBK46	TTXLS46	#	#	#
X8 / X Evo / MP3 400	06-08	TTXLBK46	TTXLS46	#	#	#
X9 Evolution	06-07	TTXLBK46	TTXLS46	#	#	#
Beverly 500	02-08	TTXLBK46	TTXLS46	#	#	#
<b>SUZUKI</b>						
GSR600	06-11	TTXLBK18	TTXLS18	TTXLG18	TTXLBL18	TTXLS18F
GSXR600	97-03	TTXLBK18	TTXLS18	TTXLG18	TTXLBL18	TTXLS18F
GSXR600	04-05	TTXLBK18	TTXLS18	TTXLG18	TTXLBL18	TTXLS18F
GSXR600	06-12	TTXLBK19	TTXLS19	TTXLG19	TTXLBL19	TTXLS19F
GSF 650 Bandit	07-12	TTXLBK22	TTXLS22	TTXLG22	TTXLBL22	#
GSX 650F	09-12	TTXLBK22	TTXLS22	TTXLG22	TTXLBL22	#
GSF 1200 Bandit	01-06	TTXLBK22	TTXLS22	TTXLG22	TTXLBL22	#
Bandit 1250/S	07-12	TTXLBK22	TTXLS22	TTXLG22	TTXLBL22	#
SV650 / S	99-08	TTXLBK39R	TTXLS39R	#	#	#
SV650 / S	09-12	TTXLBK18	TTXLS18	TTXLG18	TTXLBL18	TTXLS18F
V-Strom 650	99-11	TTXLBK39R	TTXLS39R	#	#	#
V-Strom 650	12	TTXLBK18	TTXLS18	#	#	#
SVF 650 Gladius	09-12	TTXLBK18	TTXLS18	#	#	#
GSR750	11-12	TTXLBK18	TTXLS18	TTXLG18	TTXLBL18	TTXLS18F
GSXR750	96-03	TTXLBK18	TTXLS18	TTXLG18	TTXLBL18	TTXLS18F
GSXR750	04-05	TTXLBK18	TTXLS18	TTXLG18	TTXLBL18	TTXLS18F
GSXR750	06-12	TTXLBK19	TTXLS19	TTXLG19	TTXLBL19	TTXLS19F
GSXR1000	01-04	TTXLBK18	TTXLS18	TTXLG18	TTXLBL18	TTXLS18F
GSXR1000	05-06	TTXLBK19	TTXLS19	TTXLG19	TTXLBL19	TTXLS19F
GSXR1000	07-08	TTXLBK22R	TTXLS22R	TTXLG22R	TTXLBL22R	TTXLS22RF
GSXR1000	09-12	TTXLBK54	TTXLS54	TTXLG54	#	#
SV1000/S	03-08	TTXLBK22	TTXLS22	TTXLG22	TTXLBL22	#
V-Strom 1000	02-08	TTXLBK22	TTXLS22	TTXLG22	TTXLBL22	#
GSX1300R Hayabusa	99-12	TTXLBK22	TTXLS22	TTXLG22	TTXLBL22	#
B-King	07-10	TTXLBK53	TTXLS53	#	#	#



## Titax Levers cont...

BRAKE LONG BLACK	BRAKE LONG SILVER	BRAKE LONG GOLD	BRAKE LONG BLUE	FOLDING BRAKE LONG SILVER
------------------------	-------------------------	-----------------------	-----------------------	---------------------------------

TTXRBK23R	TTXRS23R	#	#	#
TTXRBK22	TTXRS22	#	#	#
TTXRBK22	TTXRS22	#	#	#
TTXRBK22	TTXRS22	#	#	#
TTXRBK22	TTXRS22	#	#	#
TTXRBK22	TTXRS22	#	#	#
TTXRBK22	TTXRS22	#	#	#
TTXRBK22	TTXRS22	#	#	#
TTXRBK22	TTXRS22	#	#	#
TTXRBK22	TTXRS22	#	#	#
TTXRBK22	TTXRS22	#	#	#
TTXRBK22	TTXRS22	#	#	#
TTXRBK22	TTXRS22	#	#	#
TTXRBK22	TTXRS22	#	#	#
TTXRBK22	TTXRS22	#	#	#
TTXRBK30	TTXRS30	TTXRG30	#	#
TTXRBK30	TTXRS30	TTXRG30	#	#
TTXRBK30	TTXRS30	TTXRG30	#	#
TTXRBK30	TTXRS30	TTXRG30	#	#
TTXRBK30	TTXRS30	TTXRG30	#	#
TTXRBK30	TTXRS30	TTXRG30	#	#
TTXRBK30	TTXRS30	TTXRG30	#	#
TTXRBK30	TTXRS30	TTXRG30	#	#
TTXRBK30	TTXRS30	TTXRG30	#	#
TTXRBK30	TTXRS30	TTXRG30	#	#
TTXRBK30	TTXRS30	TTXRG30	#	#
TTXRBK30	TTXRS30	TTXRG30	#	#
TTXRBK37	TTXRS37	#	#	#
TTXRBK37	TTXRS37	#	#	#
TTXRBK37	TTXRS37	#	#	#
TTXRBK37	TTXRS37	#	#	#
TTXRBK37	TTXRS37	#	#	#
TTXRBK37	TTXRS37	#	#	#
TTXRBK37	TTXRS37	#	#	#
TTXRBK37	TTXRS37	#	#	#
TTXRBK37	TTXRS37	#	#	#
TTXRBK17	TTXRS17	TTXRG17	TTXRBL17	TTXRS17F
TTXRBK17	TTXRS17	TTXRG17	TTXRBL17	TTXRS17F
TTXRBK18	TTXRS18	TTXRG18	TTXRBL18	TTXRS18F
TTXRBK18R	TTXRS18R	TTXRG18R	TTXRBL18R	TTXRS18RF
TTXRBK17	TTXRS17	TTXRG17	TTXRBL17	#
TTXRBK17	TTXRS17	TTXRG17	TTXRBL17	#
TTXRBK17	TTXRS17	TTXRG17	TTXRBL17	#
TTXRBK17	TTXRS17	TTXRG17	TTXRBL17	#
TTXRBK17	TTXRS17	#	#	#
TTXRBK17	TTXRS17	TTXRG17	TTXRBL17	TTXRS17F
TTXRBK17	TTXRS17	#	#	#
TTXRBK17	TTXRS17	#	#	#
TTXRBK17	TTXRS17	#	#	#
TTXRBK17	TTXRS17	TTXRG17	TTXRBL17	TTXRS17F
TTXRBK17	TTXRS17	TTXRG17	TTXRBL17	TTXRS17F
TTXRBK18	TTXRS18	TTXRG18	TTXRBL18	TTXRS18F
TTXRBK18R	TTXRS18R	TTXRG18R	TTXRBL18R	TTXRS18RF
TTXRBK17	TTXRS17	TTXRG17	TTXRBL17	TTXRS17F
TTXRBK18R	TTXRS18R	TTXRG18R	TTXRBL18R	TTXRS18RF
TTXRBK18R	TTXRS18R	TTXRG18R	TTXRBL18R	TTXRS18RF
TTXRBK18R	TTXRS18R	TTXRG18R	#	#
TTXRBK17	TTXRS17	TTXRG17	TTXRBL17	#
TTXRBK17	TTXRS17	TTXRG17	TTXRBL17	#
TTXRBK17	TTXRS17	TTXRG17	TTXRBL17	#
TTXRBK51R	TTXRS51R	#	#	#



Titax superbike CLUTCH and BRAKE levers. Quality CNC machined levers with unique click adjuster.

All order codes shown are for LONG lever type.

To order SHORT levers, just add the letter 'A' behind the order code.



- Motorbikes
- Exhausts
- Screens
- Commuter
- Controls
- Headlights
- Indicators
- Mirrors
- Rear Lights
- Lifts & Stands
- Tools
- Batteries & Chargers
- Electrics
- Chain
- Servicing
- Tyres & Tubes
- Security
- Bike Accs
- Luggage
- Rider Accs
- Tank Pads
- Extras

## Titax Levers cont...

MODEL	YEAR	CLUTCH LONG BLACK	CLUTCH LONG SILVER	CLUTCH LONG GOLD	CLUTCH LONG BLUE	FOLDING CLUTCH LONG SILVER
<b>SUZUKI cont...</b>						
GSX1400	01-07	TTXLBK22	TTXLS22	TTXLG22	TTXLBL22	#
<b>TRIUMPH</b>						
Speed Triple	97-03	TTXLBK27	TTXLS27	TTXLG27	#	#
Speed Triple axial.	04-07	TTXLBK26	TTXLS26	TTXLG26	#	#
Speed Triple Radial.	08-10	TTXLBK26	TTXLS26	TTXLG26	#	#
Speed Triple 1050 Radial	11-12	TTXLBK26	TTXLS26	TTXLG26	#	#
Speed Four	03-04	TTXLBK27	TTXLS27	TTXLG27	#	#
Speed Four	05-06	TTXLBK26	TTXLS26	TTXLG26	#	#
TT 600	00-03	TTXLBK27	TTXLS27	TTXLG27	#	#
Daytona 600/650	04-05	TTXLBK26	TTXLS26	TTXLG26	#	#
Daytona 675	06-12	TTXLBK26	TTXLS26	TTXLG26	#	#
Daytona 675 R	11-12	TTXLBK26	TTXLS26	TTXLG26	#	#
Street Triple 675	08-12	TTXLBK26	TTXLS26	TTXLG26	#	#
Street Triple 675R	09-12	TTXLBK26	TTXLS26	TTXLG26	#	#
Speedmaster	05-12	TTXLBK26	TTXLS26	TTXLG26	#	#
Bonneville T100	06-12	TTXLBK26	TTXLS26	TTXLG26	#	#
Thruxton	04-12	TTXLBK26	TTXLS26	TTXLG26	#	#
Scrambler	06-12	TTXLBK26	TTXLS26	TTXLG26	#	#
Daytona 955i	97-03	TTXLBK27	TTXLS27	TTXLG27	#	#
Daytona 955i	04-06	TTXLBK26	TTXLS26	TTXLG26	#	#
Tiger 1050	07-12	TTXLBK26	TTXLS26	TTXLG26	#	#
Sprint ST/GT/RS/ABS	04-11	TTXLBK26	TTXLS26	TTXLG26	#	#
Sprint ST/R	97-03	TTXLBK27	TTXLS27	TTXLG27	#	#
Sprint GT/ABS	10-12	TTXLBK26	TTXLS26	TTXLG26	#	#
Rocket III	04-07	TTXLBK26	TTXLS26	TTXLG26	#	#
Tiger EFI	99-06	TTXLBK27	TTXLS27	TTXLG27	#	#
<b>YAMAHA</b>						
Majesty 400	04-12	TTXLBK43	TTXLS43	#	#	#
T-Max 500	08-12	TTXLBK43	TTXLS43	#	#	#
XT 600	98-03	TTXLBK42	#	#	#	#
XT 660 R/X	04-12	TTXLBK42	#	#	#	#
FZ6-Fazer	97-03	TTXLBK29	TTXLS29	TTXLG29	#	#
FZ6-Fazer	04-10	TTXLBK20	TTXLS20	TTXLG20	#	#
XJ6 / Diversion	09-12	TTXLBK21	TTXLS21	TTXLG21	#	#
YZFR6	99-04	TTXLBK20	TTXLS20	TTXLG20	TTXLBL20	TTXLS20F
YZFR6	05-12	TTXLBK20	TTXLS20	TTXLG20	TTXLBL20	TTXLS20F
FZ8-Fazer	10-12	TTXLBK20	TTXLS20	TTXLG20	#	#
TDM 900	05-12	TTXLBK58R	TTXLS58R	#	#	#
FZS 1000	01-05	TTXLBK21	TTXLS21	TTXLG21	TTXLBL21	#
FZ1-Fazer	06-12	TTXLBK21	TTXLS21	TTXLG21	#	#
MT-01	05-12	TTXLBK24	TTXLS24	TTXLG24	#	#
YZFR1	98-03	TTXLBK21	TTXLS21	TTXLG21	TTXLBL21	TTXLS21F
YZFR1	04-08	TTXLBK21	TTXLS21	TTXLG21	TTXLBL21	TTXLS21F
YZFR1	09-12	TTXLBK20	TTXLS20	TTXLG20	TTXLBL20	TTXLS20F
V-Max (Nisin)	all	TTXLBK24	TTXLS24	TTXLG24	#	#
V-Max	all	TTXLBK51	TTXLS51	#	#	#
XJR 1200	95-98	TTXLBK24	TTXLS24	TTXLG24	#	#
FJR 1300	01-02	TTXLBK24	TTXLS24	TTXLG24	#	#
FJR 1300/ABS	03-12	TTXLBK24	TTXLS24	TTXLG24	#	#
XTZ 1200	10-12	TTXLBK24	TTXLS24	TTXLG24	#	#
XJR 1300	99-06	TTXLBK24	TTXLS24	TTXLG24	#	#
XJR 1300	07-12	TTXLBK24	TTXLS24	TTXLG24	#	#

## Titax Levers cont...

BRAKE LONG BLACK	BRAKE LONG SILVER	BRAKE LONG GOLD	BRAKE LONG BLUE	FOLDING BRAKE LONG SILVER
------------------------	-------------------------	-----------------------	-----------------------	---------------------------------

TTXRBK17	TTXRS17	TTXRG17	TTXRBL17	#
TTXRBK17	TTXRS17	TTXRG17	#	#
TTXRBK17	TTXRS17	TTXRG17	#	#
TTXRBK18R	TTXRS18R	TTXRG18R	#	#
TTXRBK23R	TTXRS23R	TTXRG23R	#	#
TTXRBK17	TTXRS17	TTXRG17	#	#
TTXRBK17	TTXRS17	TTXRG17	#	#
TTXRBK17	TTXRS17	TTXRG17	#	#
TTXRBK17	TTXRS17	TTXRG17	#	#
TTXRBK17	TTXRS17	TTXRG17	#	#
TTXRBK17	TTXRS17	TTXRG17	#	#
TTXRBK18R	TTXRS18R	TTXRG18R	#	#
TTXRBK23R	TTXRS23R	TTXRG23R	#	#
TTXRBK17	TTXRS17	TTXRG17	#	#
TTXRBK18R	TTXRS18R	TTXRG18R	#	#
TTXRBK17	TTXRS17	TTXRG17	#	#
TTXRBK17	TTXRS17	TTXRG17	#	#
TTXRBK17	TTXRS17	TTXRG17	#	#
TTXRBK17	TTXRS17	TTXRG17	#	#
TTXRBK17	TTXRS17	TTXRG17	#	#
TTXRBK17	TTXRS17	TTXRG17	#	#
TTXRBK17	TTXRS17	TTXRG17	#	#
TTXRBK17	TTXRS17	TTXRG17	#	#
TTXRBK17	TTXRS17	TTXRG17	#	#
TTXRBK17	TTXRS17	TTXRG17	#	#
TTXRBK17	TTXRS17	TTXRG17	#	#
TTXRBK34	TTXRS34	#	#	#
TTXRBK34	TTXRS34	#	#	#
TTXRBK32	#	#	#	#
TTXRBK33	#	#	#	#
TTXRBK17	TTXRS17	TTXRG17	#	#
TTXRBK22	TTXRS22	TTXRG22	#	#
TTXRBK22	TTXRS22	TTXRG22	#	#
TTXRBK17	TTXRS17	TTXRG17	TTXRBL17	TTXRS17F
TTXRBK19R	TTXRS19R	TTXRG19R	TTXRBL19R	TTXRS19RF
TTXRBK22	TTXRS22	TTXRG22	#	#
TTXRBK48	TTXRS48	#	#	#
TTXRBK17	TTXRS17	TTXRG17	TTXRBL17	#
TTXRBK22	TTXRS22	TTXRG22	#	#
TTXRBK19R	TTXRS19R	TTXRG19R	#	#
TTXRBK20	TTXRS20	TTXRG20	TTXRBL20	TTXRS20F
TTXRBK19R	TTXRS19R	TTXRG19R	TTXRBL19R	TTXRS19RF
TTXRBK47R	TTXRS47R	TTXRG47R	TTXRBL47R	TTXRS47RF
TTXRBK17	TTXRS17	TTXRG17	#	#
TTXRBK45	TTXRS45	#	#	#
TTXRBK17	TTXRS17	TTXRG17	#	#
TTXRBK17	TTXRS17	TTXRG17	#	#
TTXRBK22	TTXRS22	TTXRG22	#	#
TTXRBK22	TTXRS22	TTXRG22	#	#
TTXRBK17	TTXRS17	TTXRG17	#	#
TTXRBK22	TTXRS22	TTXRG22	#	#



Titax superbike CLUTCH and BRAKE levers. Quality CNC machined levers with unique click adjuster.

All order codes shown are for LONG lever type.

To order SHORT levers, just add the letter 'A' behind the order code.



## Titax Spare Adjusters

Replacement lever adjusters for Titax levers. Supplied as one top and base, fits one lever.

Order Code	Colour
TTXADJBLK	Black
TTXADJGD	Gold
TTXADJR	Red
TTXADJBU	Blue



Motorcycle

Exhausts

Screens

Commuter

Controls

Headlights

Indicators

Mirrors

Rear Lights

Lifts & Stands

Tools

Batteries & Chargers

Electrics

Chain

Servicing

Tyres & Tubes

Security

Bike Accs

Luggage

Rider Accs

Tank Pads

Extras

www.bikeit.co.uk

81



## Biketek CNC Adjustable Sports Levers

Biketek adjustable levers offer a superior quality upgrade to standard OEM levers. Precision CNC machined, the levers are ergonomically designed to provide improved lever feel and control. The multi-setting adjuster enables the lever to be set at the exact reach for the rider, resulting in better control and comfort. Features grooved lever blade for better grip, with detail aero cut-out. Premium quality finish in classic anodised gunmetal colour with black adjuster, these levers will prove a stylish upgrade to all bikes. Sold individually.

**NEW**



**BIKETEK**



MODEL	YEAR	CLUTCH ORDER CODE	BRAKE ORDER CODE
-------	------	-------------------	------------------

### APRILIA

RSV Mille / R	04-08	LVRC07	LVRB06
RSV4 / RSV4 Factory	09-12	LVRC27	LVRB06

### BMW

F800S	06-12	LVRC05	LVRB02
F800ST	06-12	LVRC05	LVRB02
F800GS	08-12	LVRC05	LVRB02
F650GS	08-12	LVRC05	LVRB02
F800R	09-12	LVRC05	LVRB02
S1000RR	09-12	LVRC03	LVRB04
K1200R	05-08	LVRC01	LVRB02
K1200R Sport	06-08	LVRC01	LVRB02
K1200S	04-08	LVRC01	LVRB02
R1200R	06-11	LVRC01	LVRB02
R1200S	06-08	LVRC01	LVRB02
R1200RT	10-11	LVRC01	LVRB02
R1200ST	05-08	LVRC01	LVRB02
R1200GS	04-11	LVRC01	LVRB02
R1200GS Adventure	06-11	LVRC01	LVRB02
K1300 S/R/GT	09>	LVRC01	LVRB02
K1600 GT/GTL	11>	LVRC01	LVRB02

### DUCATI

749 S/R	03-07	LVRC07	LVRB06
848 / Evo	07-12	LVRC07	LVRB06
Streetfighter 848	12>	LVRC07	LVRB06
999 S/R	03-07	LVRC07	LVRB06
1098 /S/Tricolor	07-08	LVRC07	LVRB06
M1100 / S Monster	09-12	LVRC07	LVRB06
Diavel	11-12	LVRC07	LVRB06
1199 Panigale /S/Tricolor	12>	LVRC07	LVRB06
1198 /S/R	09-11	LVRC07	LVRB06
S4RS	06-08	LVRC07	LVRB06
Multistrada 1200 / S	10-12	LVRC07	LVRB06
Streetfighter / S	09-12	LVRC07	LVRB06

### HONDA

CB600 Hornet	98-06	LVRC13	LVRB08
CB600F Hornet	07-12	LVRC11	LVRB08
CBR 600 / F	87-07	LVRC13	LVRB08
CBR600F	11-12	LVRC11	LVRB08
CBR600RR	03-06	LVRC15	LVRB10
CBR600RR	07-12	LVRC15	LVRB12
NC700 S/X	12>	LVRC13	LVRB08
CB900 Hornet	02-07	LVRC13	LVRB08
CBR900RR	93-99	LVRC13	LVRB08
CBR929RR	00-01	LVRC13	LVRB10
CBR954RR	02-06	LVRC15	LVRB10
CB1000R	08-12	LVRC09	LVRB12
CBR1000RR	04-07	LVRC09	LVRB12
CBR1000RR	08-12	LVRC15	LVRB12
VTR1000 SP1/SP2	00-06	LVRC09	LVRB10

MODEL	YEAR	CLUTCH ORDER CODE	BRAKE ORDER CODE
-------	------	-------------------	------------------

### KAWASAKI

Ninja 400R	11>	LVRC17	LVRB14
ZXR400	all	LVRC17	LVRB20
ER-5	04-05	LVRC17	LVRB20
ER-6 F/N	06-08	LVRC17	LVRB20
ER-6N	09-12	LVRC17	LVRB14
Versys 600	06-08	LVRC17	LVRB20
Versys 600	09-12	LVRC17	LVRB14
ZZR600	90-04	LVRC17	LVRB20
ZX6R / ZX636R / ZX6RR	00-04	LVRC19	LVRB20
ZX636R / ZX6RR	05-06	LVRC19	LVRB18
ZX6R	07-12	LVRC19	LVRB16
Ninja 650R	09-12	LVRC17	LVRB14
Z750	04-06	LVRC17	LVRB20
Z750S	06-08	LVRC17	LVRB20
Z750R	11-12	LVRC19	LVRB16
ZX9R	98-99	LVRC17	LVRB20
ZX9R	00-03	LVRC19	LVRB20
Versys 1000	12>	LVRC19	LVRB20
ZX10R	04-05	LVRC19	LVRB20
ZX10R	06-12	LVRC19	LVRB16
Z1000	03-06	LVRC19	LVRB20
Z1000	07-12	LVRC19	LVRB16
Z1000 / SX	11-12	LVRC19	LVRB16
ZX12R	00-05	LVRC19	LVRB20

### SUZUKI

GSR600	06-11	LVRC23	LVRB20
GSXR600	97-03	LVRC23	LVRB20
GSXR600	04-05	LVRC23	LVRB18
GSXR600	06-10	LVRC25	LVRB18
GSXR600	11-12	LVRC27	LVRB18
DL650 V-Strom	11-12	LVRC23	LVRB20
GSF650 Bandit	07-11	LVRC21	LVRB20
GSX650F	08-12	LVRC21	LVRB20
SFV650 Gladius	09-12	LVRC23	LVRB20
GSR750	12>	LVRC23	LVRB20
GSXR750	96-03	LVRC23	LVRB20
GSXR750	04-05	LVRC23	LVRB18
GSXR750	06-10	LVRC25	LVRB18
GSXR750	11-12	LVRC27	LVRB18
DL1000 V-Strom	02-10	LVRC21	LVRB20
GSXR1000	01-04	LVRC23	LVRB20
GSXR1000	05-06	LVRC25	LVRB18
GSXR1000	07-08	LVRC21	LVRB18
GSXR1000	09-12	LVRC27	LVRB18
SV1000/S	03-08	LVRC21	LVRB20
TL1000S	97-01	LVRC23	LVRB20
TL1000R	98-03	LVRC21	LVRB20
GSF1200 Bandit	01-06	LVRC21	LVRB20
GSF1250 Bandit	07-12	LVRC21	LVRB20
GSX1250 F/SA	10-12	LVRC21	LVRB20
GSXR1300 Hayabusa	99-11	LVRC21	LVRB20
GSX1400	01-07	LVRC21	LVRB20

## Biketek CNC Adjustable Sports Levers cont...

MODEL	YEAR	CLUTCH ORDER CODE	BRAKE ORDER CODE
<b>TRIUMPH</b>			
Speed Four	05-06	<b>LVRC29</b>	<b>LVRB20</b>
Daytona 600	04-05	<b>LVRC29</b>	<b>LVRB20</b>
Daytona 650	04-05	<b>LVRC29</b>	<b>LVRB20</b>
675 Street Triple	09-12	<b>LVRC29</b>	<b>LVRB20</b>
675 Street Triple R	09-12	<b>LVRC29</b>	<b>LVRB18</b>
Daytona 675	06-12	<b>LVRC29</b>	<b>LVRB18</b>
Daytona 675 R	11-12	<b>LVRC29</b>	<b>LVRB06</b>
Speed Triple	04-07	<b>LVRC29</b>	<b>LVRB20</b>
Speed Triple	08-10	<b>LVRC29</b>	<b>LVRB18</b>
Speed Triple	11-12	<b>LVRC29</b>	<b>LVRB06</b>
Speedmaster	06-12	<b>LVRC29</b>	<b>LVRB20</b>
Bonneville T100	06-12	<b>LVRC29</b>	<b>LVRB20</b>
Tiger 800 / XC	12	<b>LVRC29</b>	<b>LVRB20</b>
Thrupton	04-12	<b>LVRC29</b>	<b>LVRB20</b>
Scrambler	06-12	<b>LVRC29</b>	<b>LVRB20</b>
Daytona 955i	04-06	<b>LVRC29</b>	<b>LVRB20</b>
Sprint ST/RS	04-11	<b>LVRC29</b>	<b>LVRB20</b>
Sprint GT/ABS	10-12	<b>LVRC29</b>	<b>LVRB20</b>
Tiger 1050	07-12	<b>LVRC29</b>	<b>LVRB20</b>
Rocket III	all	<b>LVRC29</b>	<b>LVRB20</b>

MODEL	YEAR	CLUTCH ORDER CODE	BRAKE ORDER CODE
<b>YAMAHA</b>			
FZ6 Fazer	04-10	<b>LVRC31</b>	<b>LVRB22</b>
FZ6R	09-11	<b>LVRC31</b>	<b>LVRB22</b>
XJ6 / Diversion	09-12	<b>LVRC31</b>	<b>LVRB22</b>
YZF R6	99-04	<b>LVRC31</b>	<b>LVRB20</b>
YZF R6	05-12	<b>LVRC31</b>	<b>LVRB24</b>
YZF R6S	06-07	<b>LVRC31</b>	<b>LVRB24</b>
FZ8	12>	<b>LVRC31</b>	<b>LVRB22</b>
FZS 1000	01-05	<b>LVRC31</b>	<b>LVRB20</b>
FZ1 Fazer	06-12	<b>LVRC31</b>	<b>LVRB22</b>
YZF R1	02-03	<b>LVRC31</b>	<b>LVRB20</b>
YZF R1	04-08	<b>LVRC31</b>	<b>LVRB24</b>
YZF R1	09-12	<b>LVRC31</b>	<b>LVRB26</b>

# BIKETEK

### Handlebar Accessory Mount Bracket

Designed to provide a perch for accessories that have a 22.2mm tube mounting bracket, such as Sat-Navs, smart phones and cameras. The 22.2mm diameter perch sits on an adjustable arm, the bracket has a 10mm bolt hole enabling fitment to many mounts such as mirror boss and lever clamps.

Order Code: **BARMNT15**



**NEW**

### 28.6mm Handlebar Clamp Conversion

Aluminium and CNC finished handlebar clamp, converts 22.2mm bar clamps to wider 28.6mm size, enabling use of jumbo bars of 28.6mm diameter.

Order Code: **BARRIS06**



### Handlebar Accessory Mount Top Clamp

A clever and simple solution for mounting accessories such as Sat-Navs and cameras to a motorcycle. This replacement top clamp features an extended arm with a thread mount to enable accessories to be bolted on. The top clamp will fit 22.2mm bars. Available with either M6 x 1.0 or M8 x 1.25 mounting thread. Precision CNC machined alloy with anodised gunmetal finish.

Order Code    Description  
**BARMNT05**    M6 x 1.0 thread mount  
**BARMNT10**    M8 x 1.25 thread mount



**NEW**

### Handlebar Risers

Aluminium and CNC finished handlebar riser clamps, raises bar height by 30mm. Available for 22.2mm and 28.6mm bar clamps

Order Code    Fitment  
**BARRIS02**    28.6mm handlebar  
**BARRIS04**    22.2mm handlebar



### Multi-Stage Handlebar Riser Kit

Aluminium handlebar riser kits  
 Precision quality CNC machined components  
 Premium polished finish

Features base mount, bar mount and three sizes of spacer  
 Includes three sets of M8 fitting bolts for various height options  
 4 height options (+5mm, +10mm, +15mm, +30mm)

Uses the original bar top clamp  
 Available for 22.2mm and 28.6mm bar sizes

Order Code    Fitment  
**BARRIS08**    22.2mm bar type  
**BARRIS10**    28.6mm bar type



Motocp  
 Exhausts  
 Screens  
 Commuter  
**Controls**  
 Headlights  
 Indicators  
 Mirrors  
 Rear Lights  
 Lifts & Stands  
 Tools  
 Batteries & Chargers  
 Electrics  
 Chain  
 Servicing  
 Tyres & Tubes  
 Security  
 Bike Accs  
 Luggage  
 Rider Accs  
 Tank Pads  
 Extras

www.bikeit.co.uk



## Clip-On Bar Kit

Order Code	Description
BARCP02	50mm Black
BARCP04	50mm Gold
BARCP06	50mm High Black
BARCP08	50mm High Gold
BARCP10	51mm Black
BARCP12	51mm Gold
BARCP14	53mm Black
BARCP16	53mm Gold
BARCP22	41mm Black
BARCP24	41mm Gold
BARCP26	43mm Black
BARCP28	43mm Gold
BARCP30	45mm Black
BARCP32	45mm Gold
BARCP34	46mm Black
BARCP36	46mm Gold
BARCP38	48mm Black
BARCP40	48mm Gold
BARCP42	48mm High Black
BARCP44	48mm High Gold

Premium quality clip-on bar kits, perfect for OEM replacement and upgrades. Each kit includes a pair of precision CNC-machined clamps and a pair of handlebar tubes with integrated nylon bar-ends. Available in eight clamp diameters and two colour finishes.

41mm	43mm	45mm	46mm	48mm	48mm high	50mm	50mm high	51mm	53mm
#	#	#	#	#	#	Aprilia	#	Aprilia	#
#	#	#	#	#	#	Ducati	#	#	Ducati
Honda	#	Honda	#	Honda	Honda	#	Honda	#	#
Kawasaki	Kawasaki	#	Kawasaki	#	#	Kawasaki	#	Kawasaki	#
Suzuki	#	#	Suzuki	Suzuki	#	Suzuki	#	#	#
#	#	#	#	#	#	Triumph	#	#	#
#	Yamaha	#	#	#	#	Yamaha	#	#	#

This application guide shows which clamp sizes are used by manufacturer. Please check the correct clamp size required for bike before ordering



## Replacement Clip-On Tube

Replacement handlebar tubes with integrated nylon bar-ends.

Order Code	Colour
BARCP18	Black
BARCP20	Gold

## Clip-On Tubes

**Sportsbike Clip-On Tubes. Pair**

- 22.2mm (7/8") diameter
- 280mm length
- 6061 T6 Aluminium

Order Code	Colour
BARCPBLK	Matt black
BARCPBU	Matt blue
BARCPSL	Matt silver
BARCPGD	Matt gold
BARCPR	Matt red

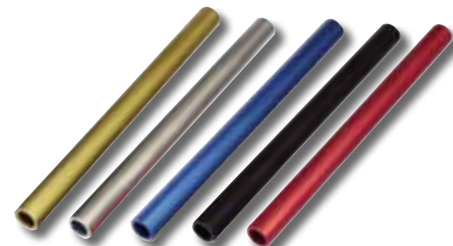

## Boxer Bar Muffs

- Protects rider's hands from wind and rain
- 3 layer neoprene construction provides optimum protection
- Unique universal fitting, grips and levers locate through the bar muff
- Contoured fit, increased comfort
- Reflective print safety feature
- Optional mirror cords

Order Code: **GRPBOX**



## Bar Pads

Handlebar crash pads available in selection of colours and designs.

Each Bar Pad includes high-density foam pad and printed vinyl sleeve with velcro fastener.

Order Code	Description
BARPAD01	Honda Red
BARPAD02	Kawasaki Green
BARPAD04	Suzuki Yellow
BARPAD05	Yamaha Blue
BARPAD06	Black
BARPAD07	Red
BARPAD08	Union Jack



## Bar Muffs

Thermal fleece lined bar muffs, protects rider's hands from wind and rain. Bar muffs slide over grips and controls, and are secured by adjustable webbing straps and buckles.

Order Code: **GRPMUFF**





## Street/Off Road Handlebars

### Universal Drag Bar

- Shot peen finish
- 22.2mm (7/8") diameter
- Width: 740mm
- Height: 62mm
- 6061 T6 Aluminium

Order Code	Colour
<b>HBD01BLK</b>	Black
<b>HBD01BU</b>	Blue
<b>HBD01GD</b>	Gold
<b>HBD01R</b>	Red
<b>HBD01SL</b>	Silver

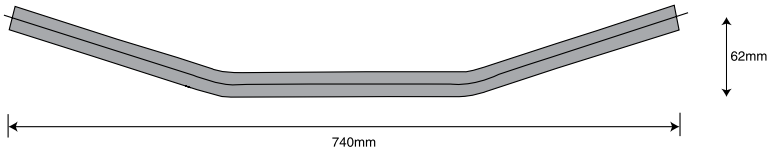

### Low Unbraced Bar

- Shot peen finish
- 22.2mm (7/8") diameter
- Width: 840mm
- Rise: 45mm
- Height: 58mm
- 6061 T6 Aluminium

Order Code	Colour
<b>HBS01BLK</b>	Black
<b>HBS01BU</b>	Blue
<b>HBS01GD</b>	Gold
<b>HBS01R</b>	Red
<b>HBS01SL</b>	Silver

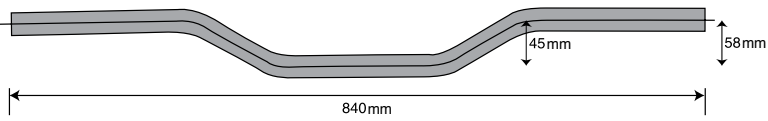

### Low Braced Bar

- Shot peen finish
- 22.2mm (7/8") diameter
- Width: 810mm
- Rise: 30mm
- Height: 45mm
- 6061 T6 Aluminium

Order Code	Colour
<b>HBM01BLK</b>	Black
<b>HBM01BU</b>	Blue
<b>HBM01GD</b>	Gold
<b>HBM01R</b>	Red
<b>HBM01SL</b>	Silver

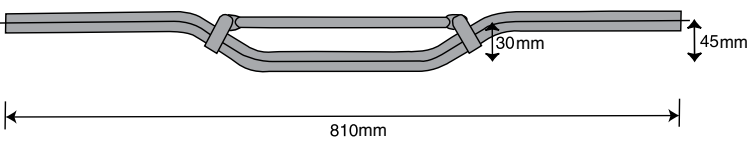

### Medium Braced Bar

- Shot peen finish
- 22.2mm (7/8") diameter
- Width: 740mm
- Rise: 47mm
- Height: 91mm
- 6061 T6 Aluminium

Order Code	Colour
<b>HBM03BLK</b>	Black
<b>HBM03BU</b>	Blue
<b>HBM03GD</b>	Gold
<b>HBM03R</b>	Red
<b>HBM03SL</b>	Silver

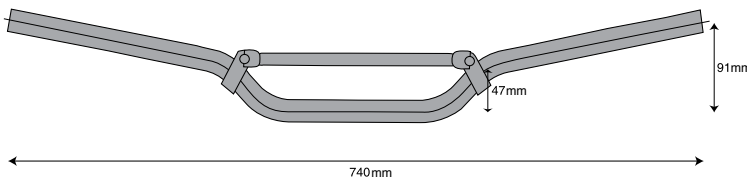

NB: All bars have an approximate ID of 14mm and will accept 13mm bar ends.

### Jumbo Off-Road Braced Bar

- 28.6mm clamp section for use with 11/8" top clamps
- 22.2mm (7/8") diameter
- Width: 802mm
- Rise: 65mm
- Height: 99mm
- 6061 T6 Aluminium

Order Code	Description
<b>BARJBBLK</b>	Matt Black
<b>BARJBBU</b>	Blue
<b>BARJBBSL</b>	Matt Silver

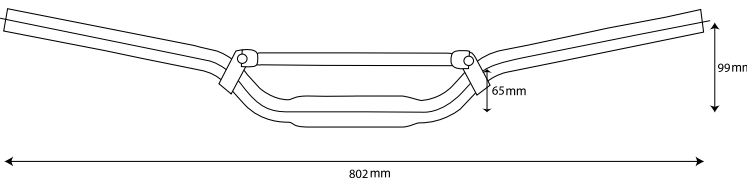

Motocross  
Exhausts  
Screens  
Commuter  
Controls  
Headlights  
Indicators  
Mirrors  
Rear Lights  
Lifts & Stands  
Tools  
Batteries & Chargers  
Electrics  
Chain  
Servicing  
Tyres & Tubes  
Security  
Bike Accs  
Luggage  
Rider Accs  
Tank Pads  
Extras

## LED Bar End Weights

These universal bar end weights are precision CNC machined, fitting all bars with 18mm internal diameter. Featuring a cut out window, super bright LEDs are inset making a superb white LED marker light, or amber LED indicator.

Order Code	Description
<b>BEWLED10</b>	White LED marker light
<b>BEWLED20</b>	Amber LED indicator

**NEW**

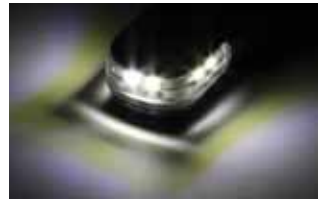

## Carbon Fibre Inset Bar End Weights

### ORIGINAL

Fits all 22mm / 7/8" bars with 18mm internal diameter. Pair.

Order Code	Colour
<b>BEWFIBAL</b>	Alloy / Carbon Fibre
<b>BEWFIBR</b>	Red / Carbon Fibre
<b>BEWFIBBU</b>	Blue / Carbon Fibre
<b>BEWFIBGD</b>	Gold / Carbon Fibre
<b>BEWFIBLK</b>	Black / Carbon Fibre



## Flush Fit Bar End Weights

Flush-fitting universal bar end weights. Includes reducer sleeves to enable dual fitment to 18mm and 13mm bar inners. Available in 5 colour options. With feature Biketek print.

Order Code	Colour
<b>BEWFLSBK</b>	Black
<b>BEWFLSBU</b>	Blue
<b>BEWFLSGD</b>	Gold
<b>BEWFLSR</b>	Red
<b>BEWFLSS</b>	Silver



## Bar End Weights

Pairs of anti-vibration bar-end weights. Fits all 22mm / 7/8" bars with 18mm or 13mm internal diameter. Complete with Allen Key.

### BULLET - 18mm

Order Code	Colour
<b>BEWBULBK</b>	Black
<b>BEWBULBU</b>	Blue
<b>BEWBULCH</b>	Chrome
<b>BEWBULGD</b>	Gold
<b>BEWBULR</b>	Red
<b>BEWBULCBN</b>	Carbon look

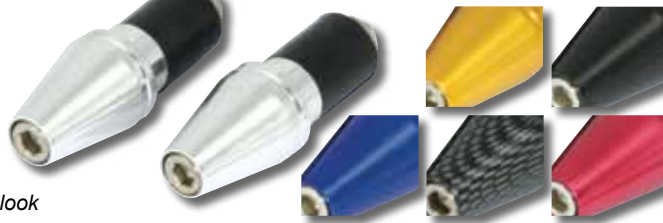

### SERRATED - 18mm

Order Code	Colour
<b>BEWSERBLK</b>	Black
<b>BEWSERBU</b>	Blue
<b>BEWSERCH</b>	Chrome
<b>BEWSERGD</b>	Gold
<b>BEWSERR</b>	Red
<b>BEWSERCBN</b>	Carbon look



### SLIM - 13mm

Order Code	Colour
<b>BEWSL13BLK</b>	Black
<b>BEWSL13BU</b>	Blue
<b>BEWSL13CH</b>	Chrome
<b>BEWSL13GD</b>	Gold
<b>BEWSL13R</b>	Red
<b>BEWSL13CBN</b>	Carbon look



### SLIM - 18mm

Order Code	Colour
<b>BEWSL22BLK</b>	Black
<b>BEWSL22BU</b>	Blue
<b>BEWSL22CH</b>	Chrome
<b>BEWSL22GD</b>	Gold
<b>BEWSL22R</b>	Red
<b>BEWSL22CBN</b>	Carbon look



### ROUND - 18mm

Order Code	Colour
<b>BEWRNDBLK</b>	Black
<b>BEWRNDBU</b>	Blue
<b>BEWRNDCH</b>	Chrome
<b>BEWRNDGD</b>	Gold
<b>BEWRNDPU</b>	Purple
<b>BEWRNDR</b>	Red



### ROUND - 13mm

Order Code	Colour
<b>BEWRN13BLK</b>	Black
<b>BEWRN13BU</b>	Blue
<b>BEWRN13CH</b>	Chrome
<b>BEWRN13GD</b>	Gold
<b>BEWRN13R</b>	Red
<b>BEWRN13CBN</b>	Carbon look



## Bar End Button

Simply pops onto exposed bar-ends! Alternative to screw fit bar-ends. 15mm fitment - black. Pair

Order Code:
<b>BEWBUTBLK</b>



Motocp  
Exhausts  
Screens  
Commuter  
Controls  
Headlights  
Indicators  
Mirrors  
Rear Lights  
Lifts & Stands  
Tools  
Batteries & Chargers  
Electrics  
Chain  
Servicing  
Tyres & Tubes  
Security  
Bike Accs  
Luggage  
Rider Accs  
Tank Pads  
Extras  
www.bikeit.co.uk



## Sports Bike Alloy Bar End Weights

Honda stepped-type, fits most models including CBR600, CBR900, CBR1000RR AND VTR

Order Code	Colour
<b>BEWHCBBBK</b>	Black
<b>BEWHCBBBU</b>	Blue
<b>BEWHCBBCH</b>	Chrome
<b>BEWHCBBGD</b>	Gold
<b>BEWHCBBRR</b>	Red



Kawasaki flush-type, fits most models including GPZ, ZX6R, ZX9R, Z1000, ZX10R, ZX12R

Order Code	Colour
<b>BEWKZBLK</b>	Black
<b>BEWKZBU</b>	Blue
<b>BEWKZCH</b>	Chrome



Suzuki flush-type, fits most early models including GSXR >99, GSXR1300, TL1000

Order Code	Colour
<b>BEWGSXRBLK</b>	Black
<b>BEWGSXRBU</b>	Blue
<b>BEWGSXRCH</b>	Chrome
<b>BEWGSXR</b>	Red



Suzuki stepped-type, fits most late models including GSXR 00>, SV650, SV1000

Order Code	Colour
<b>BEWSSVBLK</b>	Black
<b>BEWSSVCH</b>	Chrome



**NEW**

Yamaha thread-type, fits most models including YZF, FZR, TDM, XJR

Order Code	Colour
<b>BEWYFZBLK</b>	Black
<b>BEWYFZBU</b>	Blue
<b>BEWYFZCH</b>	Chrome



Yamaha flush-type, fits R1 98-12, R6 06-12

Order Code	Colour
<b>BEWYR1BLK</b>	Black
<b>BEWYR1CH</b>	Chrome



**NEW**

Yamaha thread-type, fits R6 98-06

Order Code	Colour
<b>BEWYR6BLK</b>	Black
<b>BEWYR6BU</b>	Blue
<b>BEWYR6CH</b>	Chrome
<b>BEWYR6R</b>	Red



## Cruise Control

Motorcycle cruise control / wrist rest. Allows periodic resting of throttle hand on long journeys.

**NEW**

Order Code	Size
<b>CRUC22</b>	22mm, 7/8inch handlebars
<b>CRUC25</b>	25mm, 1 inch handlebars



## Cruise Control

Cruise Control allows the throttle to be set at an open position during riding, minimising stress and strain on the rider's wrist and hand. When set, the control will maintain the bike at a constant speed, but can be instantly deactivated when needed by simply flicking the lever off. Simple accessory for comfy riding, essential for long journeys and touring.

Order Code: **CRUCON**



Universal fitting kit

## Cruise Aid

Save wrist-ache on long journeys! Clip this gadget over the throttle grip and use it as a rest for thumb heel. Simple and effective for cruising at higher speeds.

Order Code: **CRUAID**



Control on



Control off

Motorcycle  
Exhausts  
Screens  
Commuter  
Controls  
Headlights  
Indicators  
Mirrors  
Rear Lights  
Lifts & Stands  
Tools  
Batteries & Chargers  
Electrics  
Chain  
Servicing  
Tyres & Tubes  
Security  
Bike Accs  
Luggage  
Rider Accs  
Tank Pads  
Extras



## BikeTek Heated Grips

Exclusive BikeTek heated grip set, provides efficient heat to rider's hands whilst riding, essential for cold winter riding. Multi-heat settings provide perfect heating for all conditions. Simple two button controller box can be handlebar mounted for ease of on-ride use. Detail grip pattern for optimum feel. Easy installation onto all 22mm handlebars (22mm left, 25mm right grip). Supplied complete with bar-ends plugs.

Order Code: GRPHT11

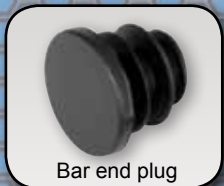

Bar end plug



Control box



Control box mount



**BIKETEK**

## Heated Grips

### ORIGINAL (ON/OFF)

Featuring a simple on/off setting switch module, the grips can be activated on and off during riding, maximum temperature point 40 degree Celsius. Pair.

Order Code	Description	Left grip	Right grip
GRPHEATB	Heated grips	25mm	28mm
GRPHEATC	Heated grips	22mm	22mm

**Available  
 for thumb throttle  
 ATV's and Quads**



\* Grip detail may vary

### TEMPERATURE ADJUSTABLE

This heated grip kit utilises a module that allows the temperature setting to be adjusted manually, to suit the weather conditions being ridden in. Heating range from 0-40 degrees, offers greater comfort and personal choice. Pair.

Order Code	Description	Left grip	Right grip
HEATGRPADJ	Heated grips	22mm	25mm



\* Grip detail may vary

## Road Grips - Pairs

Premium quality road grips with 22mm left 25mm right fitment



**Streetfighter**  
Order Code: **GRPRD07**



**Black Lozenge**  
Order Code: **GRPBR058**



**Black Tena**  
Order Code: **GRPBR TENA**



**Black Ovals**  
Order Code: **GRPBR028**



**Black Honda Type**  
Order Code: **GRPBRHON**



**Black Rippled**  
Order Code: **GRPBR018**



**Black Original**  
Order Code: **GRPBRORI**



### Foam Grips

Order Code Colour  
**GRPFBLK** Black  
**GRPFR** Red  
**GRPFBU** Blue



### Super Grips

Order Code Colour  
**GRPSUPR** Red  
**GRPSUPBLK** Black  
**GRPSUPBU** Blue  
**GRPSUPGN** Green

## Custom Street Grips

Wide selection of custom style grips with size options for 22mm and 28mm handlebars.



**Twin Ring**  
Order Code Colour Size  
**GRPRD30** Titanium 22mm left, 25mm right  
**GRPRD33** Titanium 25mm left, 25mm right



**Twin Ring**  
Order Code Colour Size  
**GRPRD31** Gold 22mm left, 25mm right



**Twin Ring**  
Order Code Colour Size  
**GRPRD32** Blue 22mm left, 25mm right



**Dragon**  
Order Code Size  
**GRPRD15** 22mm left, 25mm right  
**GRPRD17** 25mm left, 28mm right



**Tribal**  
Order Code Size  
**GRPRD19** 22mm left, 25mm right  
**GRPRD21** 25mm left, 28mm right



**Tassled**  
Order Code Size  
**GRPBRTAS22** 22mm left, 25mm right  
**GRPBRTAS25** 25mm left, 28mm right

Motocp  
Exhausts  
Screens  
Commuter  
Controls  
Headlights  
Indicators  
Mirrors  
Rear Lights  
Lifts & Stands  
Tools  
Batteries & Chargers  
Electrics  
Chain  
Servicing  
Tyres & Tubes  
Security  
Bike Accs  
Luggage  
Rider Accs  
Tank Pads  
Extras



## Custom Street Grips cont...

Wide selection of custom style grips with size options for 22mm and 28mm handlebars.



### Cube Cushion

Order Code      Size  
**GRPRD23**      22mm left, 25mm right  
**GRPRD25**      25mm left, 28mm right



### Knurled Classic

Order Code      Size  
**GRPRD27**      22mm left, 25mm right  
**GRPRD29**      25mm left, 28mm right



### Foam & Chrome

Order Code      Size  
**GRPFCH22**      22mm left, 25mm right  
**GRPFCH25**      25mm left, 28mm right  
**GRPRD11**      25mm left, 25mm right



### Carbon Look

22mm left, 25mm right  
 Order Code: **GRPCBN**



### Sundance

Order Code      Size  
**GRPCHSUN1**      1" left, 7/8" right  
**GRPCHSUN2**      1" left, 1 1/8" right  
**GRPCHSUN3**      1" left, 1" right



### Rail

Order Code      Size  
**GRPCHR22**      22mm left, 25mm right  
**GRPCHR25**      25mm left, 28mm right



### Deluxe

Order Code      Size  
**GRPDEL22BLK**      22mm left, 25mm right  
**GRPDEL25BLK**      25mm left, 28mm right



### Rail grip with end cap detail

Order Code      Size  
**GRPCHRD22**      22mm left, 25mm right  
**GRPCHRD25**      25mm left, 28mm right



### Oval

Order Code      Size  
**GRPRD36**      22mm left, 25mm right  
**GRPRD37**      25mm left, 28mm right



### Chopper

Order Code      Size  
**GRPRD34**      22mm left, 25mm right  
**GRPRD35**      25mm left, 28mm right



### Lambretta

Order Code      Size  
**GRPRD09**      25mm left, 25mm right

## Grip Glue

5ml tube of lubricant adhesive for ease of installation and secure fitment of grips.  
 Order Code: **GRPGLU5**



Motocp  
 Exhausts  
 Screens  
 Commuter  
 Controls  
 Headlights  
 Indicators  
 Mirrors  
 Rear Lights  
 Lifts & Stands  
 Tools  
 Batteries & Chargers  
 Electrics  
 Chain  
 Servicing  
 Tyres & Tubes  
 Security  
 Bike Accs  
 Luggage  
 Rider Accs  
 Tank Pads  
 Extras  
 www.bikeit.co.uk

## Grip Donuts

Chunky neoprene cushions slide onto grips to provide extra cushioning for thumbs. Prevents chafing and blisters. Pair

Order Code	Description
GRPDNT02	Honda
GRPDNT04	Kawasaki
GRPDNT08	Suzuki
GRPDNT10	Yamaha

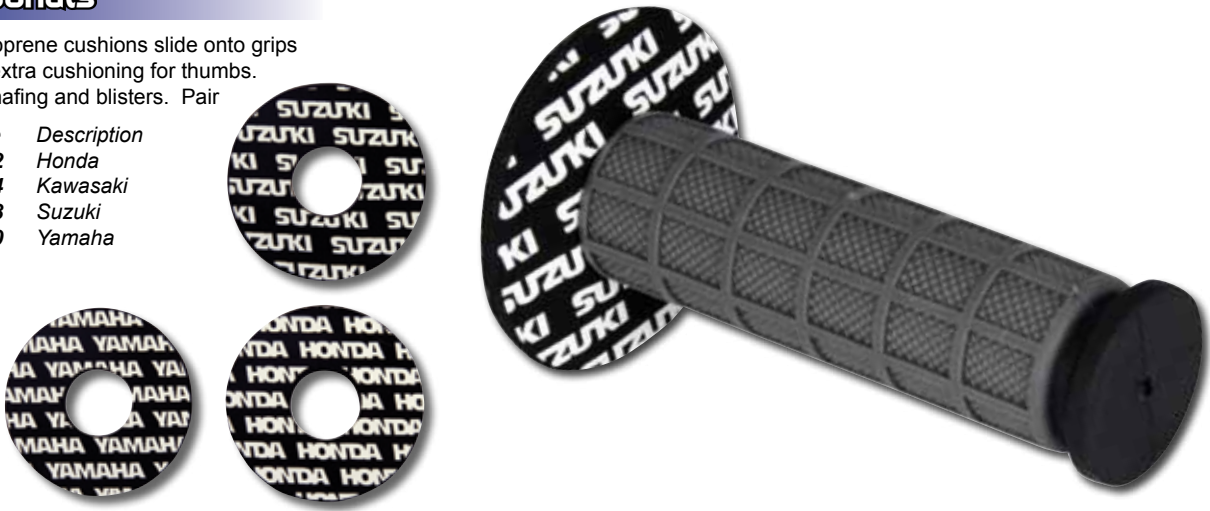

## Grip Sleeve / Clean Grips

Use clean-grips over existing handlebar grips to protect from oil and dirt. These are ideal for when the bike is being repaired or maintained, when oily hands can ruin the grips. Great for sports bikes and off-roaders. Pair.

Order Code	Description
GRPSL01	Honda
GRPSL02	Kawasaki
GRPSL03	Suzuki
GRPSL04	Yamaha



## Dual Cable / Pipe Separators

Order Code	Colour
CBSTBU	Blue
CBSTCH	Chrome
CBSTGD	Gold
CBSTR	Red



## 3 & 4 Cable / Pipe Separators

Order Code	Description
CBST03	Triple cable in Gunmetal
CBST04	Four cable in Gunmetal



## Cable Adjusters

Order Code	Description
CABAGS10CH	Chrome 10mm

Order Code	Description
CABASTDCH	Chrome 8mm



## Cable Guide

High quality aluminium cable guide. Brushed titanium finish. Superb upgrade to stock version.

Order Code	Description
CBG003	Titanium effect small 52mm
CBG006	Titanium effect large 77mm



Motocp  
Exhausts  
Screens  
Commuter  
Controls  
Headlights  
Indicators  
Mirrors  
Rear Lights  
Lifts & Stands  
Tools  
Batteries & Chargers  
Electrics  
Chain  
Servicing  
Tyres & Tubes  
Security  
Bike Accs  
Luggage  
Rider Accs  
Tank Pads  
Extras



## Lever Foams

Lever foams are tubular foam sleeves which fit over brake and clutch levers for extra grip and comfort.  
Sold in pairs.

Order Code    Colour  
**LVRFOABLK**    Black  
**LVRFOABU**    Blue  
**LVRFOAR**    Red



## Silicone Lever Sleeves

Open-ended silicone sleeves simply pull over levers. Increases finger grip for greater control.  
Range of OEM colours.  
Sold in pairs.

Order Code    Colour  
**LVRSCN02**    Black  
**LVRSCN04**    Blue  
**LVRSCN06**    Green  
**LVRSCN08**    Orange  
**LVRSCN10**    Red



## Lever Sets

OEM replacement levers are available as individual brake and clutch levers, or complete lever sets. Single levers are available in standard alloy finish, sets are available in various colour finish options.



MODEL	YEAR	ALLOY CLUTCH LEVER	ALLOY BRAKE LEVER	SET BLACK	SET ALLOY	SET BLUE	SET GOLD	SET RED
<b>APRILIA</b>								
RS 125	92-05	<i>LRA01C</i>	<i>LRA01B</i>	#	#	#	#	#
RS 125	05-10	<i>LRA01C</i>	<i>TBC</i>	#	#	#	#	#
RSV/R 1000 Mille	99-03	<i>LRD01C</i>	<i>LRD01B</i>	<i>LBD01</i>	<i>LRD01</i>	#	#	#
RSV Mille/R	04-08	<i>LRD03C</i>	<i>LRD03B</i>	<i>LBD03</i>	<i>LRD03</i>	#	#	#
Caponord/EVT 1000	02-07	<i>LRD01C</i>	<i>LRD01B</i>	<i>LBD01</i>	<i>LRD01</i>	#	#	#
TUONO 1000	02-10	<i>LRD01C</i>	<i>LRD01B</i>	<i>LBD01</i>	<i>LRD01</i>	#	#	#
<b>BIMOTA</b>								
DB5R	08-11	<i>LRD01C</i>	<i>LRD01B</i>	<i>LBD01</i>	<i>LRD01</i>	#	#	#
DB5S	06-11	<i>LRD01C</i>	<i>LRD01B</i>	<i>LBD01</i>	<i>LRD01</i>	#	#	#
DB6 Delirio	06-11	<i>LRD01C</i>	<i>LRD01B</i>	<i>LBD01</i>	<i>LRD01</i>	#	#	#
<b>DUCATI</b>								
Ducati adjustable		<i>LRD02C</i>	<i>LRD02B</i>	<i>LBD02</i>	<i>LRD02</i>	#	#	#
Ducati non-adjustable		<i>LRD04C</i>	<i>LRD04B</i>	#	<i>LRD04</i>	#	#	#
620 Sport	03-06	<i>LRD06C</i>	<i>LRD06B</i>	#	<i>LRD06</i>	#	#	#
Monster 620	06	<i>LRD02C</i>	<i>LRD02B</i>	<i>LBD02</i>	<i>LRD02</i>	#	#	#
Monster 620	03-06	<i>LRD06C</i>	<i>LRD06B</i>	#	<i>LRD06</i>	#	#	#
Multistrada 620	05-06	<i>LRD01C</i>	<i>LRD01B</i>	<i>LBD01</i>	<i>LRD01</i>	#	#	#
Monster 695	07	<i>LRD02C</i>	<i>LRD02B</i>	<i>LBD02</i>	<i>LRD02</i>	#	#	#
Monster 696	08-12	<i>LRD02C</i>	<i>LRD02B</i>	<i>LBD02</i>	<i>LRD02</i>	#	#	#
748 / 916	>98	<i>LRD02C</i>	<i>LRD02B</i>	<i>LBD02</i>	<i>LRD02</i>	#	#	#
748/750SS	99-04	<i>LRD01C</i>	<i>LRD01B</i>	<i>LBD01</i>	<i>LRD01</i>	#	#	#
749 S/R	03-07	<i>LRD03C</i>	<i>LRD03B</i>	<i>LBD03</i>	<i>LRD03</i>	#	#	#
750/900SS	91-98	<i>LRD02C</i>	<i>LRD02B</i>	<i>LBD02</i>	<i>LRD02</i>	#	#	#
750SS	99-01	<i>LRD01C</i>	<i>LRD01B</i>	<i>LBD01</i>	<i>LRD01</i>	#	#	#
Monster S2RC	06-08	<i>LRD01C</i>	<i>LRD01B</i>	<i>LBD01</i>	<i>LRD01</i>	#	#	#
800 Sport	03-06	<i>LRD05C</i>	<i>LRD05B</i>	#	<i>LRD05</i>	#	#	#
800 SS	03-06	<i>LRD01C</i>	<i>LRD01B</i>	<i>LBD01</i>	<i>LRD01</i>	#	#	#
Monster 800S	03-06	<i>LRD05C</i>	<i>LRD05B</i>	#	<i>LRD05</i>	#	#	#
848	09-12	<i>LRD03C</i>	<i>LRD03B</i>	<i>LBD03</i>	<i>LRD03</i>	#	#	#
Streetfighter S	09-12	<i>LRD03C</i>	<i>LRD03B</i>	<i>LBD03</i>	<i>LRD03</i>	#	#	#
900 SS	91-98	<i>LRD02C</i>	<i>LRD02B</i>	<i>LBD02</i>	<i>LRD02</i>	#	#	#
900 SS	99-06	<i>LRD01C</i>	<i>LRD01B</i>	<i>LBD01</i>	<i>LRD01</i>	#	#	#
900S / 1000S	98-06	<i>LRD01C</i>	<i>LRD01B</i>	<i>LBD01</i>	<i>LRD01</i>	#	#	#
M900/M1000	00-05	<i>LRD01C</i>	<i>LRD01B</i>	<i>LBD01</i>	<i>LRD01</i>	#	#	#
Monster 900	95-99	<i>LRD02C</i>	<i>LRD02B</i>	<i>LBD02</i>	<i>LRD02</i>	#	#	#
Monster 900 / S	00-02	<i>LRD01C</i>	<i>LRD01B</i>	<i>LBD01</i>	<i>LRD01</i>	#	#	#
916 / 748	>98	<i>LRD02C</i>	<i>LRD02B</i>	<i>LBD02</i>	<i>LRD02</i>	#	#	#
Monster S4/S4R	01-06	<i>LRD01C</i>	<i>LRD01B</i>	<i>LBD01</i>	<i>LRD01</i>	#	#	#
ST4 / S / ABS	04-06	<i>LRD01C</i>	<i>LRD01B</i>	<i>LBD01</i>	<i>LRD01</i>	#	#	#
Monster S2RC	06-08	<i>LRD01C</i>	<i>LRD01B</i>	<i>LBD01</i>	<i>LRD01</i>	#	#	#
Monster ST2	97-03	<i>LRD02C</i>	<i>LRD02B</i>	<i>LBD02</i>	<i>LRD02</i>	#	#	#
ST2		<i>LRD04C</i>	<i>LRD04B</i>	#	<i>LRD04</i>	#	#	#
ST3 / S / ABS	03-07	<i>LRD01C</i>	<i>LRD01B</i>	<i>LBD01</i>	<i>LRD01</i>	#	#	#

## Lever Sets cont...

MODEL	YEAR	ALLOY CLUTCH LEVER	ALLOY BRAKE LEVER	SET BLACK	SET ALLOY	SET BLUE	SET GOLD	SET RED
<b>DUCATI cont...</b>								
996/998B/S/R	99-03	LRD01C	LRD01B	LBD01	LRD01	#	#	#
Monster S4/S4R	07>	LRD03C	LRD03B	LBD03	LRD03	#	#	#
998	98-03	LRD01C	LRD01B	LBD01	LRD01	#	#	#
999 S/R	03-07	LRD03C	LRD03B	LBD03	LRD03	#	#	#
1000SS DS	03-06	LRD01C	LRD01B	LBD01	LRD01	#	#	#
Granpasso	08>	LRD03C	LRD03B	LBD03	LRD03	#	#	#
GT 1000 / S	06-10	LRD01C	LRD01B	LBD01	LRD01	#	#	#
Monster 1000S	03-06	LRD01C	LRD01B	LBD01	LRD01	#	#	#
MTS 1000 S	07	LRD01C	LRD01B	LBD01	LRD01	#	#	#
MTS 1000 SDS/DS	04-06	LRD01C	LRD01B	LBD01	LRD01	#	#	#
Multistrada 1000	04-06	LRD01C	LRD01B	LBD01	LRD01	#	#	#
Paul Smart LE	06	LRD01C	LRD01B	LBD01	LRD01	#	#	#
Sport 1000	06-08	LRD01C	LRD01B	LBD01	LRD01	#	#	#
1098	07-08	LRD03C	LRD03B	LBD03	LRD03	#	#	#
Monster 1100	09-10	LRD03C	LRD03B	LBD03	LRD03	#	#	#
Multistrada 1100 / S	07-09	LRD01C	LRD01B	LBD01	LRD01	#	#	#
1198 / S	09-11	LRD03C	LRD03B	LBD03	LRD03	#	#	#
<b>HONDA</b>								
ANF 125 Innova	03-09	N/A	LRH20B*	#	#	#	#	#
CBF 125	09-10	LRH22C*	LRH22B*	#	#	#	#	#
CBR 125R	04>	LRH14C	LRH14B	#	LRH14	#	#	#
CG125 W>	97-01	LRH16C	LRH16B	#	LRH16	#	#	#
CG125 M	01-04	LBH20C*	LBH20B*	LBH20	#	#	#	#
FES 125	98-02	#	LRH26B	#	#	#	#	#
FES 125	03-11	#	LRH25B	#	#	#	#	#
SES 125 Dylan	03-04	LRH21C	LRH21B	#	#	#	#	#
SH 125	01-03	LRH21C	LRH21B	#	#	#	#	#
VT 125	99-06	LRH27C	N/A	#	#	#	#	#
XL 125 Varadero	01-03	LRH28C*	LRH28B*	#	#	#	#	#
XL 125 Varadero	04-12	LRH29C	LRH28B	#	#	#	#	#
XLR 125	98>	LRH24C*	LRH24B*	#	#	#	#	#
XR 125 R	03-08	LRH23C*	LRH23B*	#	#	#	#	#
CBR 250RR		LRH01C	LRH01B	LBH01	LRH01	LAH01BU	LAH01GD	LAH01R
VFR 400 R3 (NC30)	89-93	LRH01C	LRH01B	LBH01	LRH01	LAH01BU	LAH01GD	LAH01R
CBR400R (NC23/29)	90-94	LRH01C	LRH01B	LBH01	LRH01	LAH01BU	LAH01GD	LAH01R
RVF400R (NC35) 92		LRH01C	LRH01B	LBH01	LRH01	LAH01BU	LAH01GD	LAH01R
CBF 500	04-06	TBC	TBC	#	TBC	#	#	#
CBF 600	07	LRH08C	LRH08B	LBH08	LRH08	LAH08BU	LAH08GD	#
CBF 600	08-09	TBC	TBC	#	TBC	#	#	#
CB 600 Hornet SF-S6	98-06	LRH08C	LRH08B	LBH08	LRH08	LAH08BU	LAH08GD	#
CB 600 F Hornet	07-12	TBC	TBC	#	TBC	#	#	#
CBR 600 FK-FW	88-98	LRH01C	LRH01B	LBH01	LRH01	LAH01BU	LAH01GD	LAH01R
CBR 600 FX-F7	99-07	LRH08C	LRH08B	LBH08	LRH08	LAH08BU	LAH08GD	#
CBR 600 FS-1/FS-2 Sport	01-03	LRH05C	LRH05B	#	LRH05	#	#	#
CBR 600RR	03-06	LRH12C	LRH12B	LBH12	LRH12	#	#	#
CBR 600RR	07-12	LRH18C	LRH18B	LBH18	LRH18	#	#	#
Deauville	06-07	LRH08C	LRH08B	LBH08	LRH08	LAH08BU	LAH08GD	#
Magna VF 750C	02>	LRH08C	LRH08B	LBH08	LRH08	LAH08BU	LAH08GD	#
VFR 750 FH-FV	87-97	LRH03C	LRH03B	LBH03	LRH03	LAH03BU	LAH03GD	LAH03R
VFR 750 RJ-RL (RC30)	88-93	LRH03C	LRH03B	LBH03	LRH03	LAH03BU	LAH03GD	LAH03R
RVF 750R (RC45)	94-99	LRH03C	LRH03B	LBH03	LRH03	LAH03BU	LAH03GD	LAH03R
VFR 800 Fi-W-1	98-01	LRH03C	LRH03B	LBH03	LRH03	LAH03BU	LAH03GD	LAH03R
VFR 800 Vtec	02-10	LRH02C	LRH02B	#	LRH02	#	#	#
CB 900 Hornet	02-07	LRH09C	LRH09B	#	LRH09	#	#	#
CBR 900RR N-V	92-97	LRH01C	LRH01B	LBH01	LRH01	LAH01BU	LAH01GD	LAH01R
CBR 900RR W-X	98-99	LRH04C	LRH04B	#	LRH04	#	#	#
CBR 900RR (929)	00-01	LRH13C	LRH13B	LBH13	LRH13	#	#	#
CBR 900RR (954)	02-06	LRH11C	LRH11B	#	LRH11	#	#	#
CB 1000 P-T	93-97	LRH17C	LRH17B	#	LRH17	#	#	#
CB 1000R	08-12	LRH15C	LRH15B	LBH15	LRH15	#	#	#
CBF 1000	06-09	LRH03C	LRH03B	LBH03	LRH03	LAH03BU	LAH03GD	LAH03R
CBR 1000F H-X	87-99	LRH17C	LRH17B	#	LRH17	#	#	#
CBR 1000RR	04-07	LRH15C	LRH15B	LBH15	LRH15	#	#	#
CBR 1000RR	08-12	LRH18C	LRH18B	LBH18	LRH18	#	#	#
VTR 1000F Firestorm	97-05	LRH02C	LRH02B	#	LRH02	#	#	#
VTR 1000 SP1/SP2	00-06	LRH10C	LRH10B	#	LRH10	LAH10BU	#	#
XL 1000 Varadero	99-12	LRH31C	LRH03B	#	#	#	#	#
CBR 1100XX Blackbird	96-07	LRH03C	LRH03B	LBH03	LRH03	LAH03BU	LAH03GD	LAH03R
CB 1300 / ABS	03-09	LRH30C	LRH30B	#	LRH30	#	#	#
<b>KAWASAKI</b>								
BN 125 Eliminator	98-04	LRK09C	LRK09B	#	#	#	#	#
ZZR 250	90-93	LRK03C	LRK03B	LBK03	LRK03	LAK03BU	#	LAK03R
ZXR 400L	91-03	LRK03C	LRK03B	LBK03	LRK03	LAK03BU	#	LAK03R

Individual clutch and brake levers are supplied in alloy finish except where shown \* when the original colour is black

MotorGP  
 Exhausts  
 Screens  
 Commuter  
 Controls  
 Headlights  
 Indicators  
 Mirrors  
 Rear Lights  
 Lifts & Stands  
 Tools  
 Batteries & Chargers  
 Electronics  
 Chain  
 Servicing  
 Tyres & Tubes  
 Security  
 Bike Accs  
 Luggage  
 Rider Accs  
 Tank Pads  
 Extras  
 www.bikeit.co.uk



## Lever Sets cont...

OEM replacement levers are available as individual brake and clutch levers, or complete lever sets. Single levers are available in standard alloy finish, sets are available in various colour finish options.



MODEL	YEAR	ALLOY CLUTCH LEVER	ALLOY BRAKE LEVER	SET BLACK	SET ALLOY	SET BLUE	SET GOLD	SET RED
-------	------	--------------------	-------------------	-----------	-----------	----------	----------	---------

### KAWASAKI cont...

ER-5 A1	96	LRK04C	LRK04B	#	LRK04	#	#	#
ER-5 A2/3/4	97-00	LRK03C	LRK03B	LBK03	LRK03	LAK03BU	#	LAK03R
ER-5 C1>	01>	LRK03C	LRK03B	LBK03	LRK03	LAK03BU	#	LAK03R
ER-5	04-05	LRK08C	LRK08B	LBK08	LRK08	#	#	#
GPZ500S A6-D6	92-99	LRK03C	LRK03B	LBK03	LRK03	LAK03BU	#	LAK03R
KLE 500	91-97	LRK08C	LRK08B	LBK08	LRK08	#	#	#
ZR550 Zephyr B2-B6	91-98	LRK03C	LRK03B	LBK03	LRK03	LAK03BU	#	LAK03R
ER-6 F/N	06-11	LRK10C	LRK10B	#	LRK10	#	#	#
ER-6 F/N	12	LRK10C	TBC	#	#	#	#	#
ZX6-R F1-3	95-97	LRK03C	LRK03B	LBK03	LRK03	LAK03BU	#	LAK03R
ZX6-R G1-G2	98-99	LRK08C	LRK08B	LBK08	LRK08	#	#	#
ZX6-R J	00-02	LRK06C	LRK06B	LBK06	LRK06	#	#	#
ZX6-R	03-04	LRK15C	LRK15B	LBK15	LRK15	#	#	#
ZX6-R	05-06	LRK14C	LRK14B	LBK14	LRK14	#	#	#
ZX6-R	07-12	LRK12C	LRK12B	LBK12	LRK12	#	#	#
ZZ-R 600 D/E	90-05	LRK03C	LRK03B	LBK03	LRK03	LAK03BU	#	LAK03R
Versys	06-12	LRK08C	LRK08B	LBK08	LRK08	#	#	#
ZR-7/S	99-03	LRK08C	LRK08B	LBK08	LRK08	#	#	#
ZX7R / RR	89-03	LRK02C	LRK02B	LBK02	LRK02	#	#	#
ZXR 750/R H-M	89-96	LRK02C	LRK02B	LBK02	LRK02	#	#	#
Z 750	04-06	LRK08C	LRK08B	LBK08	LRK08	#	#	#
Z 750	07-12	LRK07C	#	#	#	#	#	#
Zephyr 750	91-97	LRK08C	LRK08B	LBK08	LRK08	#	#	#
GPZ900R	90-94	LRK02C	LRK02B	LBK02	LRK02	#	#	#
ZX9-R B	94-97	LRK02C	LRK02B	LBK02	LRK02	#	#	#
ZX9-R C	98-99	LRK08C	LRK08B	LBK08	LRK08	#	#	#
ZX9-R E	00-03	LRK07C	LRK07B	LBK07	LRK07	#	#	#
ZX10RR	04-05	LRK07C	LRK07B	LBK07	LRK07	#	#	#
ZX10RR	06-11	LRK12C	LRK12B	LBK12	LRK12	#	#	#
GPZ 1000 / ABS	95-98	LRK02C	LRK02B	LBK02	LRK02	#	#	#
GTR 1000	92-06	LRK02C	LRK02B	LBK02	LRK02	#	#	#
Z 1000	03-06	LRK07C	LRK07B	LBK07	LRK07	#	#	#
Z 1000 / SX	07-12	LRK12C	LRK12B	LBK12	LRK12	#	#	#
ZX10 B	88-90	LRK02C	LRK02B	LBK02	LRK02	#	#	#
Zephyr 1100	all	LRK02C	LRK02B	LBK02	LRK02	#	#	#
GPZ 1100 / ABS E/F	95-98	LRK02C	LRK02B	LBK02	LRK02	#	#	#
ZZR 1100 C	90-02	LRK02C	LRK02B	LBK02	LRK02	#	#	#
ZZR 1100	93-01	LRK08C	LRK08B	LBK08	LRK08	#	#	#
ZRX1100 / 1200	99-07	LRK02C	LRK02B	LBK02	LRK02	#	#	#
ZX12-R	00-05	LRK07C	LRK07B	LBK07	LRK07	#	#	#
ZZR 1200	02-05	LRK02C	LRK02B	LBK02	LRK02	#	#	#
ZZR 1400 (ZX-14)	06-12	LRK11C	LRK11B	LBK11	LRK11	#	#	#
VN 1500 Classic & Tourer	98-03	LRK02C	LRK02B	LBK02	LRK02	#	#	#
VN 1500 Mean Streak	02-03	LRK02C	LRK02B	LBK02	LRK02	#	#	#
VN 1600 Classic & Tourer	03-05	LRK02C	LRK02B	LBK02	LRK02	#	#	#
VN 1600 Mean Streak	04-06	LRK02C	LRK02B	LBK02	LRK02	#	#	#

### SUZUKI

GZ 125 X-K2 Marauder	98-02	LRS17C	LRS17B	#	#	#	#	#
RG 125F Gamma / Wolf	92-95	LRS08C	LRS08B	LBS08	LRS08	LAS08BU	LAS08GD	LAS08R
RV 125	03-04	LRS18C	LRS18B	#	#	#	#	#
UH 125 Burgman	02-04	LRS19C	LRS18B	#	#	#	#	#
VL 125 Intruder	99-08	LRS18C	LRS20B	#	#	#	#	#
RGV 250 K-T	89-96	LRS01C	LRS01B	LBS01	LRS01	LAS01BU	#	LAS01R
GSF 400 Bandit	91-95	LRS01C	LRS01B	LBS01	LRS01	LAS01BU	#	LAS01R
GS 500E L	89>	LRS08C	LRS08B	LBS08	LRS08	LAS08BU	LAS08GD	LAS08R
GS500F K4>	04>	LRS08C	LRS08B	LBS08	LRS08	LAS08BU	LAS08GD	LAS08R
GSF600/S Bandit S-X	95-99	LRS08C	LRS08B	LBS08	LRS08	LAS08BU	LAS08GD	LAS08R
GSF600/S Bandit Y-K4	00-04	LRS10C	LRS10B	#	LRS10	#	#	#
GSR 600	06-11	LRS03C	LRS03B	LBS03	LRS03	LAS03BU	#	#
GSX600 FK-FX	89-98	LRS01C	LRS01B	LBS01	LRS01	LAS01BU	#	LAS01R
GSXR600 RX/Y	99-00	LRS05C	LRS05B	#	LRS05	#	#	#
GSXR600 RV, K1-3	96-03	LRS03C	LRS03B	LBS03	LRS03	LAS03BU	#	#
GSXR600	04-05	LRS09C	LRS09B	LBS09	LRS09	#	#	#
GSXR 600	06-12	LRS11C	LRS11B	LBS11	LRS11	#	#	#
RF600 RP-RV	93-96	LRS01C	LRS01B	LBS01	LRS01	LAS01BU	#	LAS01R
DL 650	99-08	LRS01C	LRS01B	LBS01	LRS01	LAS01BU	#	LAS01R
GSF 650 Bandit (oil cooled)	05-06	LRS16C	LRS16B	#	LRS16	#	#	#
GSF 650 Bandit (water cooled)	07-12	LRS04C	LRS04B	LBS04	LRS04	LAS04BU	#	LAS04R

## Lever Sets cont...

MODEL	YEAR	ALLOY CLUTCH LEVER	ALLOY BRAKE LEVER	SET BLACK	SET ALLOY	SET BLUE	SET GOLD	SET RED
<b>SUZUKI cont...</b>								
GSX 650F	08-12	LRS04C	LRS04B	LBS04	LRS04	LAS04BU	#	LAS04R
SV650 / S	99-08	LRS01C	LRS01B	LBS01	LRS01	LAS01BU	#	LAS01R
SV650 / S	09-12	LRS03C	LRS03B	LBS03	LRS03	LAS03BU	#	#
V-Strom 650	99-11	LRS01C	LRS01B	LBS01	LRS01	LAS01BU	#	LAS01R
SFV 650 Gladius	09-12	LRS03C	LRS01B	#	#	#	#	#
GSX750 FK-FX	89-98	LRS01C	LRS01B	LBS01	LRS01	LAS01BU	#	LAS01R
GSX750 Unfairred	98-99	LRS08C	LRS08B	LBS08	LRS08	LAS08BU	LAS08GD	LAS08R
GSXR750 J-WS	88-95	LRS01C	LRS01B	LBS01	LRS01	LAS01BU	#	LAS01R
GSXR750 T-K3	96-03	LRS03C	LRS03B	LBS03	LRS03	LAS03BU	#	#
GSXR750 K4-K5	04-05	LRS09C	LRS09B	LBS09	LRS09	#	#	#
GSXR750 K6-K10	06-12	LRS11C	LRS11B	LBS11	LRS11	#	#	#
RF 900 RR-RW	94-97	LRS02C	LRS02B	LBS02	LRS02	LAS02BU	LAS02GD	#
GSXR1000 K1-K4	01-04	LRS03C	LRS03B	LBS03	LRS03	LAS03BU	#	#
GSXR1000 K5-K6	05-06	LRS11C	LRS11B	LBS11	LRS11	#	#	#
GSXR1000 K7-K8	07-08	LRS14C	LRS14B	LBS14	LRS14	#	#	#
GSXR1000 K9>	09-12	TBC	TBC	TBC	TBC	#	#	#
SV 1000/S	03-08	LRS04C	LRS04B	LBS04	LRS04	LAS04BU	#	LAS04R
DL 1000	03-08	LRS04C	LRS04B	LBS04	LRS04	LAS04BU	#	LAS04R
TL 1000 S	97-01	LRS03C	LRS03B	LBS03	LRS03	LAS03BU	#	#
V-Strom 1000	02-08	LRS04C	LRS04B	LBS04	LRS04	LAS04BU	#	LAS04R
TL 1000 R	98-99	LRS04C	LRS04B	LBS04	LRS04	LAS04BU	#	LAS04R
GSX 1100 GM-GN	91-95	LRS02C	LRS02B	LBS02	LRS02	LAS02BU	LAS02GD	#
GSX 1400	01-07	LRS04C	LRS04B	LBS04	LRS04	LAS04BU	#	LAS04R
GSXR 1100 K-N	89-93	LRS02C	LRS02B	LBS02	LRS02	LAS02BU	LAS02GD	#
GSXR 1100 WP-WT	93-96	LRS02C	LRS02B	LBS02	LRS02	LAS02BU	LAS02GD	#
GSF 1200 / S Bandit T-V	99-00	LRS02C	LRS02B	LBS02	LRS02	LAS02BU	LAS02GD	#
GSF 1200 / S Bandit	01-06	LRS04C	LRS04B	LBS04	LRS04	LAS04BU	#	LAS04R
Bandit 1250/S	07-12	LRS12C	LRS12B	#	LRS12	#	#	#
GSX1300R Hayabusa	99-12	LRS04C	LRS04B	LBS04	LRS04	LAS04BU	#	LAS04R
<b>TRIUMPH</b>								
All Hydraulic Models	91>	LRT01C	LRT01B	LBT01	LRT01	#	#	#
Speed Triple	97-03	LRT01C	LRT01B	LBT01	LRT01	#	#	#
Speed Triple	03-05	LRT02C	TBC	TBC	#	#	#	#
Street Triple	09-12	TBC	LRT02B	TBC	#	#	#	#
Speed Triple	09-12	TBC	LRT02B	TBC	#	#	#	#
Speed Four	03-04	LRT01C	LRT01B	LBT01	LRT01	#	#	#
Daytona 600	03-04	LRT02C	TBC	TBC	#	#	#	#
Daytona 650	04-05	LRT02C	TBC	TBC	#	#	#	#
Daytona 675	06>	N/A	LRT02B	N/A	#	#	#	#
Daytona 675	06-08	LRT02C	LRT02B	#	LRT02	#	#	#
TT 600	00-03	LRT01C	LRT01B	LBT01	LRT01	#	#	#
Daytona 955i	97-03	LRT01C	LRT01B	LBT01	LRT01	#	#	#
Daytona 955i	03-05	LRT02C	TBC	TBC	#	#	#	#
Sprint ST/R	97-03	LRT01C	LRT01B	LBT01	LRT01	#	#	#
Sprint ST	03-05	LRT02C	TBC	TBC	#	#	#	#
Tiger EFI	99-06	LRT01C	LRT01B	LBT01	LRT01	#	#	#
<b>YAMAHA</b>								
DT 125 RE	04-06	LRV22C	LRV22B	#	#	#	#	#
DT 125 X	05-06	LRV22C	LRV22B	#	#	#	#	#
Majesty YP125	01-04	LRV20C*	LRV20B*	#	#	#	#	#
SR 125	92-00	LRV24C	LRV21B	#	#	#	#	#
TW125	00-04	LRV22C	LRV22B	#	#	#	#	#
XQ 125 Maxster	02-04	LRV30C	LRV30B	#	#	#	#	#
XT125R	05-07	LRV19C*	LRV19B*	#	#	#	#	#
XVS125 Dragstar	00-04	LRV21C	LRV21B	#	#	#	#	#
YBR125	05-08	LRV11C	LRV11B	#	#	#	#	#
YZF-R125	08>	LRV18C	LRV18B	#	LRV18	#	#	#
RD 350N 1/2/F2	85-88	LRV04C	LRV04B	#	LRV04	#	#	LAY04R
FZR 400 RR SP	91-92	LRV01C	LRV01B	#	LRV01	#	#	#
FZR 400 RR	92-96	LRV04C	LRV04B	#	LRV04	#	#	LAY04R
RD 500LC		LRV04C	LRV04B	#	LRV04	#	#	LAY04R
FZ 600 Fazer	97-03	LRV09C	LRV09B	#	LRV09	#	#	#
FZ6-Fazer	04-10	LRV10C	LRV10B	#	LRV10	#	#	#
FZR 600 Genesis		LRV02C	LRV02B	#	LRV02	#	#	#
FZR 600 R	94-96	LRV04C	LRV04B	#	LRV04	#	#	LAY04R
XJ 600S	92-96	LRV13C	LRV13B	#	LRV13	#	#	#
XJ 600 N	96>	LRV13C	LRV13B	#	LRV13	#	#	#
XJ6 / Diversion	09-12	LRV10C	LRV10B	#	LRV10	#	#	#
YZFR6	99-03	LRV23C	LRV23B	LBY23	LRV23	LAY07BU	#	LAY07R
YZFR6	04-05	LRV06C	LRV24B	LBY24	LRV24	LAY06BU	#	#
YZFR6	06-12	LRV12C	LRV12B	LBY12	LRV12	#	#	#
YZF 600 Thundercat	96-04	LRV04C	LRV04B	#	LRV04	#	#	LAY04R
YZF 750 R/SP	93-96	LRV03C	LRV03B	LBY03	LRV03	LAY03BU	#	LAY03R
FZ8-Fazer	10-12	LRV10C	LRV10B	#	LRV10	#	#	#

Individual clutch and brake levers are supplied in alloy finish except where shown \* when the original colour is black

Motorc  
 Exhausts  
 Screens  
 Commuter  
 Controls  
 Headlights  
 Indicators  
 Mirrors  
 Rear  
 Lights  
 Lifts &  
 Stands  
 Tools  
 Batteries &  
 Chargers  
 Electrics  
 Chain  
 Servicing  
 Tyres &  
 Tubes  
 Security  
 Bike  
 Accs  
 Luggage  
 Rider  
 Accs  
 Tank  
 Pads  
 Extras  
 www.bikeit.co.uk



## Lever Sets cont...

MODEL	YEAR	ALLOY CLUTCH LEVER	ALLOY BRAKE LEVER	SET BLACK	SET ALLOY	SET BLUE	SET GOLD	SET RED
<b>YAMAHA cont...</b>								
TDM 850	91>	LRY13C	LRY13B	#	LRY13	#	#	#
TRX 850	96-99	LRY04C	LRY04B	#	LRY04	#	#	LAY04R
XJ 900 S	96>	LRY13C	LRY13B	#	LRY13	#	#	#
FZR 1000	95>	LRY03C	LRY03B	LBY03	LRY03	LAY03BU	#	LAY03R
FZS 1000	01-05	LRY23C	LRY23B	LBY23	LRY23	#	#	#
FZ1-Fazer	06-12	LRY10C	LRY10B	#	LRY10	#	#	#
YZFR1	98	LRY06C	LRY24B	LBY24	LRY24	LAY06BU	#	#
YZFR1	99-04	LRY23C	LRY23B	LBY23	LRY23	#	#	#
YZFR1	05-06	LRY12C	LRY12B	LBY12	LRY12	#	#	#
YZFR1	07-12	LRY12C	LRY12B	LBY12	LRY12	#	#	#
YZF 1000R Thunderace	96-03	LRY03C	LRY03B	LBY03	LRY03	LAY03BU	#	LAY03R
V-Max (Nisin)	all	LRY03C	LRY03B	LBY03	LRY03	LAY03BU	#	LAY03R
FJ 1200		LRY03C	LRY03B	LBY03	LRY03	LAY03BU	#	LAY03R
XJR 1200	95-98	LRY03C	LRY03B	LBY03	LRY03	LAY03BU	#	LAY03R
XJR 1200	98>	LRY03C	LRY03B	LBY03	LRY03	LAY03BU	#	LAY03R
XJR 1300	99-06	LRY03C	LRY03B	LBY03	LRY03	LAY03BU	#	LAY03R
XTZ 1200	10-12	LRY17C	LRY17B	LBY17	LRY17	#	#	#
FJR 1300	01-02	LRY03C	LRY03B	LBY03	LRY03	LAY03BU	#	LAY03R
FJR 1300/ABS	03-12	LRY17C	LRY17B	LBY17	LRY17	#	#	#
XJR 1300	07-12	LRY17C	LRY17B	LBY17	LRY17	#	#	#

## Lever Range

Aprilia LRA01C



Aprilia LRA01B



Aprilia LRD01 & Ducati LRD01



Aprilia LRD03 & Ducati LRD03

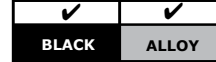

Ducati LRD02



Ducati LRD04



Ducati LRD05



Ducati LRD06



Honda LRH01



Honda LRH02



OEM replacement levers are available as individual brake and clutch levers, or complete lever sets. Single levers are available in standard alloy finish, sets are available in various colour finish options.

Motocp  
Exhausts  
Screens  
Commuter  
Controls  
Headlights  
Indicators  
Mirrors  
Rear Lights  
Lifts & Stands  
Tools  
Batteries & Chargers  
Electrics  
Chain  
Servicing  
Tyres & Tubes  
Security  
Bike Accs  
Luggage  
Rider Accs  
Tank Pads  
Extras  
www.bikeit.co.uk

## Lever Range cont...

Honda LRH03



✓	✓	✓	✓	✓
BLACK	ALLOY	BLUE	GOLD	RED

Honda LRH05



✓
ALLOY

Honda LRH09



✓
ALLOY

Honda LRH11



✓
ALLOY

Honda LRH13



✓	✓
BLACK	ALLOY

Honda LRH15



✓	✓
BLACK	ALLOY

Honda LRH17



✓
ALLOY

Honda LRH04



✓
ALLOY

Honda LRH08



✓	✓	✓	✓
BLACK	ALLOY	BLUE	GOLD

Honda LRH10



✓
ALLOY

Honda LRH12



✓	✓
BLACK	ALLOY

Honda LRH14



✓
ALLOY

Honda LRH16



✓
ALLOY

Honda LRH18



✓	✓
BLACK	ALLOY

[Motorcycle](#)  
[Exhausts](#)  
[Screens](#)  
[Commuter](#)  
[Controls](#)  
[Headlights](#)  
[Indicators](#)  
[Mirrors](#)  
[Rear Lights](#)  
[Lifts & Stands](#)  
[Tools](#)  
[Batteries & Chargers](#)  
[Electrics](#)  
[Chain](#)  
[Servicing](#)  
[Tyres & Tubes](#)  
[Security](#)  
[Bike Accs](#)  
[Luggage](#)  
[Rider Accs](#)  
[Tank Pads](#)  
[Extras](#)



# Lever Range cont...

Honda LBH20



✓  
BLACK

Honda LRH20B



✓  
BLACK

Honda LRH21C



✓  
ALLOY

Honda LRH21B



✓  
ALLOY

Honda LRH22C



✓  
BLACK

Honda LRH22B



✓  
BLACK

Honda LRH23C



✓  
BLACK

Honda LRH23B



✓  
BLACK

Honda LRH24C



✓  
BLACK

Honda LRH24B



✓  
BLACK

Honda LRH25B



✓  
BLACK

Honda LRH26B



✓  
BLACK

Honda LRH27C



✓  
ALLOY

Honda LRH28C



✓  
BLACK

Honda LRH28B



✓  
BLACK

Honda LRH29C



✓  
BLACK

Honda LRH30



✓  
ALLOY

Honda LRH31C



✓  
ALLOY

OEM replacement levers are available as individual brake and clutch levers, or complete lever sets. Single levers are available in standard alloy finish, sets are available in various colour finish options.

Motocp  
Exhausts  
Screens  
Commuter  
Controls  
Headlights  
Indicators  
Mirrors  
Rear Lights  
Lifts & Stands  
Tools  
Batteries & Chargers  
Electrics  
Chain  
Servicing  
Tyres & Tubes  
Security  
Bike Accs  
Luggage  
Rider Accs  
Tank Pads  
Extras  
www.bikeit.co.uk

# Lever Range cont...

Kawasaki LRK02



✓	✓
BLACK	ALLOY

Kawasaki LRK03



✓	✓
BLACK	ALLOY

Kawasaki LRK04



✓
ALLOY

Kawasaki LRK06



✓	✓
BLACK	ALLOY

Kawasaki LRK07



✓	✓
BLACK	ALLOY

Kawasaki LRK08



✓	✓
BLACK	ALLOY

Kawasaki LRK09C



✓
ALLOY

Kawasaki LRK09B



✓
ALLOY

Kawasaki LRK10



✓
ALLOY

Kawasaki LRK11



✓	✓
BLACK	ALLOY

Kawasaki LRK12



✓	✓
BLACK	ALLOY

Kawasaki LRK14



✓	✓
BLACK	ALLOY

Kawasaki LRK15



✓	✓
BLACK	ALLOY

Suzuki LRS01



✓	✓	✓
BLACK	ALLOY	BLUE

Suzuki LRS02



✓	✓	✓	✓
BLACK	ALLOY	BLUE	GOLD

Motocp  
Exhausts  
Screens  
Commuter  
Controls  
Headlights  
Indicators  
Mirrors  
Rear Lights  
Lifts & Stands  
Tools  
Batteries & Chargers  
Electrics  
Chain  
Servicing  
Tyres & Tubes  
Security  
Bike Accs  
Luggage  
Rider Accs  
Tank Pads  
Extras



# Lever Range cont...

Suzuki LRS03



✓	✓	✓
BLACK	ALLOY	BLUE

Suzuki LRS04



✓	✓	✓
BLACK	ALLOY	BLUE

Suzuki LRS05



✓
ALLOY

Suzuki LRS08



✓	✓	✓	✓	✓
BLACK	ALLOY	BLUE	GOLD	RED

Suzuki LRS09



✓	✓
BLACK	ALLOY

Suzuki LRS10



✓
ALLOY

Suzuki LRS11



✓	✓
BLACK	ALLOY

Suzuki LRS12



✓
ALLOY

Suzuki LRS14



✓	✓
BLACK	ALLOY

Suzuki LRS16



✓
ALLOY

Suzuki LRS17C



✓
ALLOY

Suzuki LRS17B



✓
ALLOY

Suzuki LRS18C



✓
ALLOY

Suzuki LRS18B



✓
ALLOY

Suzuki LRS19C



✓
ALLOY

Suzuki LRS20B



✓
ALLOY

MotoGP  
 Exhausts  
 Screens  
 Commuter  
**Controls**  
 Headlights  
 Indicators  
 Mirrors  
 Rear Lights  
 Lifts & Stands  
 Tools  
 Batteries & Chargers  
 Electrics  
 Chain  
 Servicing  
 Tyres & Tubes  
 Security  
 Bike Accs  
 Luggage  
 Rider Accs  
 Tank Pads  
 Extras  
 www.bikeit.co.uk

# Lever Range cont...

Triumph LRT01



✓	✓
BLACK	ALLOY

Triumph LRT02



✓
ALLOY

Yamaha LRY01



✓
ALLOY

Yamaha LRY02



✓
ALLOY

Yamaha LRY03



✓	✓	✓	✓
BLACK	ALLOY	BLUE	RED

Yamaha LRY04



✓	✓
ALLOY	RED

Yamaha LRY06C



✓
ALLOY

Yamaha LRY07



✓	✓
BLUE	RED

Yamaha LRY09



✓
ALLOY

Yamaha LRY10



✓
ALLOY

Yamaha LRY11C



✓
ALLOY

Yamaha LRY11B



✓
ALLOY

Yamaha LRY12



✓	✓
BLACK	ALLOY

Yamaha LRY13



✓
ALLOY

MotoGP  
 Exhausts  
 Screens  
 Commuter  
**Controls**  
 Headlights  
 Indicators  
 Mirrors  
 Rear Lights  
 Lifts & Stands  
 Tools  
 Batteries & Chargers  
 Electrics  
 Chain  
 Servicing  
 Tyres & Tubes  
 Security  
 Bike Accs  
 Luggage  
 Rider Accs  
 Tank Pads  
 Extras

## Lever Range cont...

Yamaha LRY17

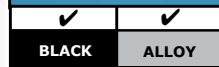

Yamaha LRY18



Yamaha LRY19C



Yamaha LRY19B



Yamaha LRY20C



Yamaha LRY20B



Yamaha LRY21C



Yamaha LRY21B



Yamaha LRY22C



Yamaha LRY22B



Yamaha LRY23



Yamaha LRY24

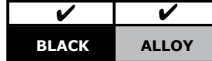

Yamaha LRY30C



Yamaha LRY30B



## British Type Levers

Traditional British cable-type clutch and brake levers in high chrome finish. Features bar clamp and cable adjuster. Sold separately.

Brake lever  
Order Code: LVR005BR



Clutch lever  
Order Code: LVR005CL



Motocp  
Exhausts  
Screens  
Commuter  
Controls  
Headlights  
Indicators  
Mirrors  
Rear Lights  
Lifts & Stands  
Tools  
Batteries & Chargers  
Electrics  
Chain  
Servicing  
Tyres & Tubes  
Security  
Bike Accs  
Luggage  
Rider Accs  
Tank Pads  
Extras  
www.bikeit.co.uk



## Dash Universal Sports Fairing Headlight

Universal sports fairing with integrated smoked screen. Twin headlight unit features 12v 35w bulbs. Also includes built-in indicators, and two extra sets of anodised reflector stems.

Order Code	Colour
<b>HLUSFBLK</b>	Black
<b>HLUSFBU</b>	Blue
<b>HLUSFR</b>	Red
<b>HLUSFW</b>	White
<b>HLUSFCBN</b>	Carbon look

**REPLACEMENT BULBS**  
Replacement double filament headlight bulb  
12V 35/35W (P15d-25-1)

Order Code: **BLB01**



## Universal Raptor II Fairing Headlight

Universal Raptor fairing with dark screen, twin headlight with 12v 35w bulbs.

Order Code	Colour
<b>HLURAPBLK</b>	Black
<b>HLURAPBU</b>	Blue
<b>HLURAPR</b>	Red
<b>HLURAPY</b>	Yellow
<b>HLURAPCH</b>	Chrome

**REPLACEMENT BULBS**  
Replacement double filament headlight bulb  
12V 35/35W (P15d-25-1)

Order Code: **BLB01**



## Dart Fairing Headlight

Universal fitting durable plastic fairing headlight. 12V 35/35W bulb with separate 12V 5W parking light. Four rubber fork-mounting brackets supplied.

Order Code	Colour
HLUDARBLK	Black
HLUDARBU	Blue
HLUDARGN	Green
HLUDAROR	Orange
HLUDARR	Red
HLUDARW	White
HLUDARY	Yellow



## Demon Universal Fairing Headlight

This neat fairing incorporates twin headlights (12V 25/25W) and side indicators (12V 10W), set below a smoked fly screen. Universal fitting to standard headlight brackets, "Demon" is available in three colour options.

Order Code	Colour
HLUDEMBLK	Black
HLUDEMBU	Blue
HLUDEMR	Red

BULBS	
BLB35	T13 12v 10w (Indicator)
BLB05	12v25/25w PX15D-1 T19 (Headlight)



NB: Demon headlights are not supplied with fitting kit.

## Falcon Universal Fairing Headlight

Universal fairing headlight with H3 12v 55w bulb. Fully E-marked. Upgrade screens available separately. Complete with fitting kit.

Order Code	Colour
HLUFALBLK	Black/Black
HLUFALBU	Black/Blue
HLUFALR	Black/Red



Motocp  
Exhausts  
Screens  
Commuter  
Controls  
Headlights  
Indicators  
Mirrors  
Rear Lights  
Lifts & Stands  
Tools  
Batteries & Chargers  
Electrics  
Chain  
Servicing  
Tyres & Tubes  
Security  
Bike Accs  
Luggage  
Rider Accs  
Tank Pads  
Extras  
www.bikeit.co.uk



## Aura Universal Fairing Headlight

Universal fairing headlight with twin headlight bulbs and inbuilt indicators.

Order Code Colour  
**HLUAURBLK** Black  
**HLUAURBU** Blue  
**HLUAURR** Red

**REPLACEMENT BULBS**  
**BLB01** 12V 35/35W (P15d-25-1)  
 (Headlight)  
**BLB42** 12v 10w Wedge (Indicator)



## Raider Fairing Headlight

Universal plastic fairing headlight with four rubber mounting brackets for fork fitting. 12v 35/35w bulb with separate 12v 5w parking light.

Order Code Colour  
**HLURAIBLK** Black  
**HLURAIBU** Blue  
**HLURAIR** Red  
**HLURAIW** White

**REPLACEMENT BULBS**  
**BLB37** Headlight 12v 35/35w  
 BA20D  
**BLB34** Parking Light 12v 5w



## Fairing Brackets

Simple adjustable size fairing headlight rubber bracket, as used on EMX headlight. 1 piece.

Order Code: **HLBEMX**



Fairing type universal headlight bracket kit (pair) designed for fitting fairing headlights to front forks. Multi diameter fork fitting. Fully adjustable headlight fitting plate with 2 bolt securing option.

Order Code: **HLB002**



Motocp  
 Exhausts  
 Screens  
 Commuter  
 Controls  
 Headlights  
 Indicators  
 Mirrors  
 Rear Lights  
 Lifts & Stands  
 Tools  
 Batteries & Chargers  
 Electrics  
 Chain  
 Servicing  
 Tyres & Tubes  
 Security  
 Bike Accs  
 Luggage  
 Rider Accs  
 Tank Pads  
 Extras



**NEW**

### Dominator 2.0 Twin Projector Headlight

Premium CNC machined twin headlight. Aggressive Matt Black street styled housing. Features twin projector H4 headlights. Dual fitting methods; install by side mounts using headlight brackets (not supplied), or by bottom mount using the mounting bolts (included). Hi Beam / Low Beam. Available in UK left dip and Euro right dip. 7" housing width. E-marked.



Shown with bottom mount bolts

Order Code	Description
HLUDMN02	UK left dip
HLUDMN04	Euro right dip

### Universal Projector Headlight (UK)

Projector headlights are universal fitting, extremely popular for special bike builders for combining in nose cones or just exposed. H1 12v 55w

Order Code	Description
HLUPRJ06	Low beam, Left dip for UK
HLUPRJ04	High beam, No dip direction



### City Headlight

Universal rectangle headlight. 130x105x85mm. S2 12v 35/35w bulb. Centre dip.

Order Code: HLUREC11



### Universal Projector Headlight E-Marked (European)

Universal projector headlights with E-mark for continental European use, include H1 12v/55W bulbs

Order Code	Description
HLUPRJ08	Hi Beam only, no dip direction
HLUPRJ10	Low Beam only, Right dip for continental Europe



### 7" Chrome

7" chrome headlight. HS1 35/35W bulb. E-marked. Dip to right.

Order Code: HLURND12



Motocp  
Exhausts  
Screens  
Commuter  
Controls  
Headlights  
Indicators  
Mirrors  
Rear Lights  
Lifts & Stands  
Tools  
Batteries & Chargers  
Electrics  
Chain  
Servicing  
Tyres & Tubes  
Security  
Bike Accs  
Luggage  
Rider Accs  
Tank Pads  
Extras

## Dominator Headlight

### TWIN

"Dominator" twin headlight set, 3.5" diameter side mount unit with H4 12v60/55w bulbs, e-marked. Dominator headlights have a centre dipped beam, E-marked for European use - the user should check their country regulations.

Order Code	Colour
<b>HLUTRCH</b>	Chrome
<b>HLUTRCBN</b>	Carbon look
<b>HLUTRBLK</b>	Matt black
<b>HLUTRCHU</b>	Replacement light unit



Replacement light unit

## Twin Dominator Fly Screen

Order Code	Colour
<b>SCRUDOM05</b>	Dark Smoked
<b>SCRUDOM06</b>	Light Smoked
<b>SCRUDOM07</b>	Blue
<b>SCRUDOM08</b>	Iridium



## Single Dominator Headlight

"Dominator" Single headlight set, 3.5" diameter bottom mount unit with H4 12v60/55w bulbs, e-marked. Dominator headlights have a centre dipped beam, E-marked for European use - the user should check their country regulations.

Order Code	Colour
<b>HLUSRCH</b>	Chrome
<b>HLUSRCBN</b>	Carbon look
<b>HLUSRBLK</b>	Matt black
<b>HLUTRCHU</b>	Replacement light unit



Replacement light unit

## Universal Chrome Triangle Headlight

Universal chrome headlight, with triangle shape lens/body. Adjustable bottom-mount. Centre-dip lens. H6 12V 35/35W bulb.

Order Code:  
**HLUTANCH**



## Bullet Headlight

High chrome bullet shaped 4 1/2" headlight. Bottom mounting, with H4 bulb and centre beam dip.

Order Code:  
**HLUBUL45**



Motocp  
Exhausts  
Screens  
Commuter  
Controls  
Headlights  
Indicators  
Mirrors  
Rear Lights  
Lifts & Stands  
Tools  
Batteries & Chargers  
Electrics  
Chain  
Servicing  
Tyres & Tubes  
Security  
Bike Accs  
Luggage  
Rider Accs  
Tank Pads  
Extras



## Halo 5 3/4" Headlight

5 3/4" round headlight, premium alloy body and rim. 'Halo' feature white LED ring around reflector rim. Classic street custom styling body. Features H4 60/55W bulb. Available in side mount and bottom mount options. Choose from Matt Black and High Chrome finishes. Hi Beam / Low Beam (centre dip). E-Marked.

**NEW**



Halo feature



Order Code	Description
HLUHAL14	Side mount, Matt Black
HLUHAL16	Side mount, High Chrome
HLUHAL18	Bottom mount, Matt Black
HLUHAL20	Bottom mount, High Chrome

## Bates Headlights (UK)

NON E-MARKED (for UK use)

Order Code	Description
HLUSB534	5 3/4" side mount
HLUBB534	5 3/4" bottom mount
HLUBB412	4 1/2" Bottom mount
HLUINN01	5 1/2" Universal headlight inner unit complete with H4 12V 60/55W bulb and 12V5W parking light module. Left dip



## Bates Headlights (European)

EUROPEAN E-MARKED HEADLIGHTS

Order Code	Description
HLUSB534E	5 3/4" side mount
HLUBB534E	5 3/4" bottom mount
HLUBB412E	4 1/2" bottom mount
HLUINN12	5 1/2" Universal headlight inner unit complete with H4 12V 60/55W bulb and 12V5W parking light module. Right dip



Above e-marked headlights have beam direction suitable for use outside the UK.

## Bates Headlights Visors

High chrome visor peaks simply locate between the housing-rim and glass deflector. Suitable for use with all 5 3/4" and 4 1/2" Bates headlights.

Order Code	Description
HLV412B	4 1/2" Bates headlight visor
HLV534B	5 3/4" Bates headlight visor



## Universal Headlights

**7" HEADLIGHT**  
7" ABS shell in solid colour with chrome effect rim. 12v 25/25w bulb.

Order Code	Colour
HLU7RBU	Blue
HLU7RBLK	Black
HLU7RR	Red
HLU7RW	White



7" Round

**UNIVERSAL CHROME**  
ABS Shell headlights with chrome effect coating.

Order Code	Size
HLU5RCH	5"
HLU7RCH	7"

Universal chrome

**TWIN HEADLAMP WITH FLIP COVER**  
Order Code: HLU7T



**STREETFIGHTER H3 12v 55w**  
Order Code: HLUTSF





## E-Marked Headlights

E-Marked headlight inner units for UK and continental Europe use with corresponding beam-dips.

These 170mm (7") inner units can be used with most 7" round headlights, or with the headlight casing shown below.

Each inner unit is compatible with H4 bulbs and holders, and pre-drilled with a parking light socket (bulbs and sockets not included).

Order Code	Description
<b>HLUEUNIT7</b>	Right hand dip for continental Europe and right-hand drive countries
<b>HLUINN13</b>	Left hand dip for UK and left-hand drive countries

7" round chrome headlight casing, ready for use with e-marked headlight inner units above

Order Code: **HLU7CHCASE**

**NEW**



HLUEUNIT7, HLUINN13



HLU7CHCASE

## Halogen Spot/Fog Lights

Bottom mount halogen fog / spotlights, plastic black body with H3 12V bulbs supplied as a pair.

Order Code: **HLUTSPOT**



## Twin Spotlights

Pack of 2 sets of twin spotlights with snap-on covers.

Order Code:  
**HLUTWINCOV**



## Spotlights

Attractive running spotlights feature an exclusive rainbow effect lens, creating a broad colour spectrum beam. These unique spotlights are fitted with a 12V 35W bulb and feature a chrome peak. (Universal fitment)

Order Code	Description
<b>HLURAIN</b>	Rainbow spotlight 5cm diameter
<b>HLUSPEC</b>	Spectrum spotlight 4cm diameter

BULBS	
<b>BLB25</b>	12v35W bulb for Spectrum
<b>BLB29</b>	12v35W bulb for Rainbow



## Replacement Headlights

Order Code	MODELS
<b>HONDA</b>	
<b>HLHC70</b>	C70E/C90E CUB
<b>HLHH100</b>	H100 CD125/185/200T CB100N/CG125BR
<b>HLHCB125</b>	CB125TDC
<b>HLHCB250</b>	CB250N
<b>HLHCB900</b>	CB900 All Chrome

<b>SUZUKI</b>	
<b>HLSGS125</b>	GS125/ZR50

<b>YAMAHA</b>	
<b>HLYRD125</b>	RD125LC/TZR125
<b>HLYDT125</b>	DT125LC/DT125R/TZR250
<b>HLYRD250</b>	RD250/350LC



HLHCB900



HLHCB250



HLHH100



HLHCB125



HLHC70



HLSGS125



HLYRD125



HLYDT125



HLYRD250

MotorCP  
Exhausts  
Screens  
Commuter  
Controls  
Headlights  
Indicators  
Mirrors  
Rear Lights  
Lifts & Stands  
Tools  
Batteries & Chargers  
Electrics  
Chain  
Servicing  
Tyres & Tubes  
Security  
Bike Accs  
Luggage  
Rider Accs  
Tank Pads  
Extras

MotoGP  
 Exhausts  
 Screens  
 Commuter  
 Controls  
 Headlights  
 Indicators  
 Mirrors  
 Rear Lights  
 Lifts & Stands  
 Tools  
 Batteries & Chargers  
 Electrics  
 Chain  
 Servicing  
 Tyres & Tubes  
 Security  
 Bike Accs  
 Luggage  
 Rider Accs  
 Tank Pads  
 Extras  
 www.bikeit.co.uk

## Stealth Headlight Brackets

Premium quality headlight brackets featuring black finished clamp and bracket. Expanded range of bracket-rubbers to fit all sizes including USD forks.

Order Code	Size (ID of rubber)
HLBSTLA	30-32mm
HLBSTLB	33-37mm
HLBSTLC	38-40mm
HLBSTLD	41-43mm
HLBSTLE	44-46mm
HLBSTLF	47-49mm
HLBSTLG	50-53mm
HLBSTLH	54-57mm

HLBSTLA



HLBSTLH



## Deluxe Headlight Brackets

Deluxe headlight brackets with choice of coloured stems. Pairs.

Order Code	Colour
HLBDBLK	Black
HLDBBU	Blue
HLBDCH	Chrome
HLBDGD	Gold

Brackets are supplied with 31mm rubbers as standard.

### HEADLAMP BRACKET RUBBERS

Pairs

Order Code	Size
HLBRUB31	31mm
HLBRUB35	35mm
HLBRUB38	38mm
HLBRUB41	41mm



## Standard Headlight Brackets

Pairs.

Order Code	Description
HLBSBLK	Black
HLBSCH	Chrome
HLBSCBN	Carbon look



2 Adjustable setting - approx 28-36mm

## Bottom Mount Headlight Bracket

Headlight and spotlight mounting bracket plate. Fits one bottom mount headlight. 1pc only. Suitable for Dominators and Bates.

Order Code: **HLB001**



## Headlight Bracket Spacers

Rubber spacers fit between headlamp bracket and headlight unit. 28mm diameter. 10mm width. 10mm inner bolt hole.

**NEW**

Order Code: **HLBSPC13**



## Headlight Brackets

High polished chrome headlight brackets complete with cuttable inner rubbers for optimum fit. Pairs.

30-38mm  
Order Code: **HLB7CH**

49-54mm (down to 40mm with extra rubber)  
Order Code: **HLB003**

43-48mm (down to 38mm with extra rubber)  
Order Code: **HLB004**



HLB003

HLB004

HLB7CH



## Halogen Bulbs

Replacement halogen headlight bulbs are available individually as white and lazer blue.

BULB TYPE	LAZER BLUE 1 PIECE PACK	WHITE 1 PIECE PACK
H1 12v 55w	<b>BLB10BU</b>	<b>BLB10W</b>
H1 12v 100w		<b>BLB11W</b>
H3 12v 55w	<b>BLB12BU</b>	<b>BLB12W</b>
H3 12v 100w	<b>BLB13BU</b>	
H4 12v 35/35 p43	<b>BLB14BU</b>	<b>BLB14W</b>
H4 12v 60/55 p43	<b>BLB15BU</b>	<b>BLB15W</b>
H4 12v 100/80 p43	<b>BLB16BU</b>	<b>BLB16W</b>
H4 12v 60/55 p45	<b>BLB17BU</b>	<b>BLB17W</b>
H4 12v 100/80 p45	<b>BLB18BU</b>	<b>BLB18W</b>
H7 12v 55w	<b>BLB19BU</b>	<b>BLB19W</b>
H7 12v 100w	<b>BLB20BU</b>	<b>BLB20W</b>



See below reference guide for base types.  
All bulbs are E-marked

### Bulb base reference guide

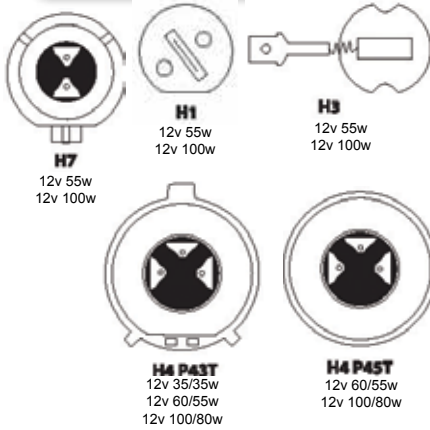

### Parking Light Unit

Universal parking light module with 12V 5W push fit bulb. Rubber base holder fits into headlight reflector hole (diameter 12mm - 16mm)



Order Code: **BLB34**

### Headlamp Clip

W-clip retains reflector unit to rim.

Order Code: **HLUCLP09**

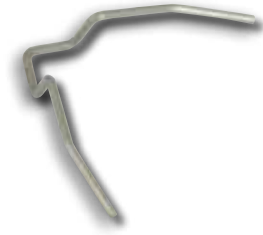

## Headlight Bulbs

Order Code	Description	Qty	Base	Volt	Watt	Bulb	Colour	For
<b>BLB01</b>	12v 35/35w P15d-25-1 H6M	1	P15d-25-1	12	35/35	H6M (HS)	Clear	Headlight (Raptor II, Dash, Aura)
<b>BLB05</b>	12v 25/25w PX15D-1 T19	1	PX15D-1	12	25/25	T19	Clear	Headlight (Demon)
<b>BLB21</b>	12v 35w Halogen	1	#	12	35	#	Clear	Headlight (Enduro)
<b>BLB23</b>	12v 20w Convex bulb kit Blue	1	#	12	20	#	#	Headlight Vertica
<b>BLB24</b>	12v 20w Convex bulb kit Clear	1	#	12	20	#	#	Headlight Vertica
<b>BLB25</b>	12v 35w Halogen	1	#	12	35	#	Iridium	Headlight (Spectrum)
<b>BLB29</b>	12v 35w Halogen	1	#	12	35	#	Iridium	Headlight (Rainbow)
<b>BLB32</b>	12v 20w MR16 13°	1	#	12	20	MR16	Clear	Headlight (Rage)
<b>BLB33</b>	12v 20w MR11 13°	1	#	12	20	MR11	Clear	Headlight (Rage)
<b>BLB36</b>	12v 4w T8.5 BA9S	1	BA9S	12	4	T8.5	Clear	Headlight (EMX)
<b>BLB37</b>	12v 35/35w BA20D	1	BA20D	12	35/35	#	Clear	Headlight (EMX/Raider)
<b>BLB38</b>	12v 5w	1	Wedge	12	5	T10	Clear	
<b>BLB41</b>	12v 20w MR16	1	#	12	20	MR16	Rainbow	Headlight (Rage)
<b>BLB43</b>	12v 35w	1	#	12	35	#	Clear	Headlight (Spectre)
<b>BLB45</b>	12v 40/40w PX15D-1 T19	1	PX15D-1	12	40/40	T19	Clear	Headlight (Demon)
<b>BLB48</b>	12v LED	1	Wedge	12	#	T10	Clear	



Motorcycle  
Exhausts  
Screens  
Commuter  
Controls  
Headlights  
Indicators  
Mirrors  
Rear Lights  
Lifts & Stands  
Tools  
Batteries & Chargers  
Electrics  
Chain  
Servicing  
Tyres & Tubes  
Security  
Bike Accs  
Luggage  
Rider Accs  
Tank Pads  
Extras

### LED Tornado Indicators

Air-flow design indicator body with feature central cut-out. Super-bright amber LEDs. 85mm width. Rubberised mounting stem. E-Marked.

Order Code: **INDLED61**

**NEW**



For LED relays  
see page 125

### LED Boggle Indicators

High power single LED indicator. Micro body with boggle eye lens. Compact 50mm width. Rubberised mounting stem. E-Marked.

Order Code	Description
<b>INDLED58</b>	Black body
<b>INDLED59</b>	Chrome body

**NEW**

**METAL BODIED**

For LED relays  
see page 125



### LED Spirit Indicators

Classic-styled high quality machined metal bodied indicators. Feature LED function with black lenses. E-marked.

Order Code	Description
<b>INDLED45</b>	Black body
<b>INDLED46</b>	Chrome body



For LED relays  
see page 125

**METAL BODIED**



### LED Micro Oval Indicators

A tiny bodied CNC machined indicator (40mm x 17mm lens), finished in high chrome. Clear lens with amber LED's. E-marked.

Order Code: **INDLED13**

**METAL BODIED**

For LED relays  
see page 125



\* Please note that this item is not available in Germany



## LED Chevron Indicators



Flat-backed Chevron shaped flush indicator.  
Super-bright amber LEDs.  
6mm bolt fitment, suitable for fairings and number plate hangers.  
60mm width.  
E-Marked.

**NEW**

Order Code:  
**INDLED60**

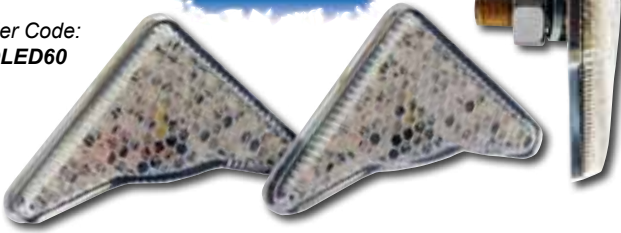

## Zip LED Fairing Indicators

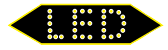

Self-Adhesive fairing fitment  
2 high powered amber LEDs in each unit

Order Code: **INDLED50**



## LED Runner Two Indicators

Latest design indicator features single 'runner' layout of 4 ultra-bright amber LEDs  
Unique translucent lens surround captures emitted light for increased visibility  
Chrome body with translucent white lens surrounds  
E-marked

Order Code	Description
<b>INDLED53</b>	Chrome body, white translucent lens



**For LED relays  
see page 125**



## LED Runner One Indicators

Latest design indicator features single 'runner' layout of 4 ultra-bright amber LEDs  
Unique translucent lens surround captures emitted light for increased visibility  
Black body available in translucent black and amber lens surrounds  
E-marked

Order Code	Description
<b>INDLED51</b>	Black body, black translucent lens
<b>INDLED52</b>	Black body, amber translucent lens

**For LED relays  
see page 125**

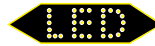

## LED Ice Indicators

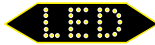

High power single LED (12V/3W)  
Unique clear frosted lens indicator  
Size 55mm(W) x 21mm (H)  
E-marked

Order Code: **INDLED47**

**For LED relays  
see page 125**

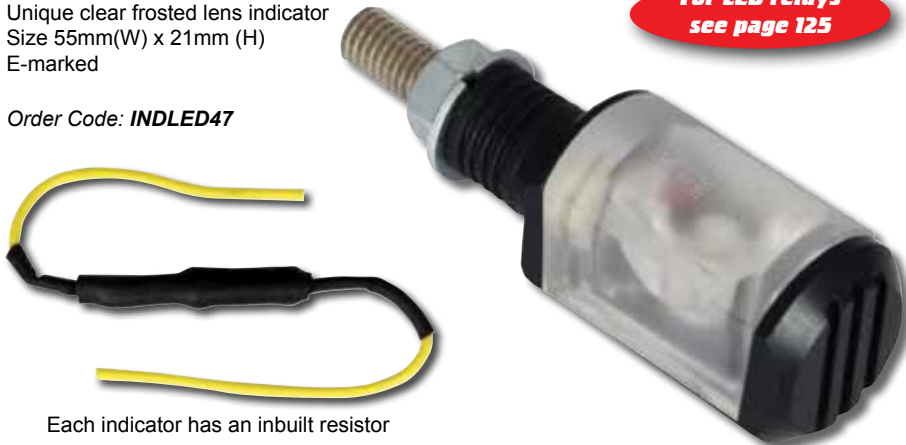

Each indicator has an inbuilt resistor

Motorcycle  
Exhausts  
Screens  
Commuter  
Controls  
Headlights  
Indicators  
Mirrors  
Rear Lights  
Lifts & Stands  
Tools  
Batteries & Chargers  
Electrics  
Chain  
Servicing  
Tyres & Tubes  
Security  
Bike Accs  
Luggage  
Rider Accs  
Tank Pads  
Extras

### LED Blade Indicators

**NEW**

Aggressive styling indicator with two feature cut-outs.  
Super-bright amber LEDs.  
75mm width.  
E-Marked.



Order Code: **INDLED63**



### LED Force Indicators

Compact LED indicator with safety end cut out for increased visibility.  
E-marked.

Order Code	Description
<b>INDLED25</b>	Short Stem Black
<b>INDLED26</b>	Long Stem Black
<b>INDLED27</b>	Short Stem Carbon
<b>INDLED28</b>	Long Stem Carbon



**For LED relays see page 125**



### LED POD Indicators

**For LED relays see page 125**

Measuring just 55mm from base to tip, with a 30mm x 20mm lens, POD indicators are a fantastic mini unit featuring bright inset LED's.  
E-marked.

Order Code	Description
<b>INDLED36</b>	Black
<b>INDLED37</b>	Chrome



### LED Diamond Indicators

**For LED relays see page 125**

These indicators utilise bright, fast LED's set into a neat diamond shape body.  
Available in black, as either short or long stem options.  
E-marked.

Order Code	Stem	Body Colour
<b>INDLED09</b>	Short stem	Black
<b>INDLED10</b>	Long stem	Black





## LED Fairing Insert Indicators

Easy and effective solution to upgrade OEM fairing indicators. These indicators are shaped to fit the hole left after removing the factory originals.

- Simple screw fit installation.
- Do not require additional fairing spacers.
- E-marked.

Description	Clear Order Code	Smoke Order Code
Honda	<b>INDLED14</b>	<b>INDLED54</b>
Kawasaki	<b>INDLED15</b>	<b>INDLED55</b>
Suzuki >00	<b>INDLED29</b>	#
Suzuki 01>	<b>INDLED16</b>	<b>INDLED56</b>
Yamaha >01	<b>INDLED22</b>	#
Yamaha 02>	<b>INDLED17</b>	<b>INDLED57</b>

**For LED relays  
see page 125**

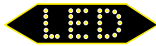

## Fairing Indicator Risers

Fairing Indicator Risers are rubber mounts which fit directly into the fairing cavity. The mounts raise the height of fairing indicators to offer improved visibility of the indicator to other road users. Suitable for use with flush-fit and stalked indicators. Available for majority of modern sportsbikes.

Order Code	Fitment
<b>INDRIS06</b>	Honda
<b>INDRIS02</b>	Kawasaki
<b>INDRIS12</b>	Suzuki >00
<b>INDRIS08</b>	Suzuki 01>
<b>INDRIS10</b>	Yamaha >01
<b>INDRIS04</b>	Yamaha 02>



## LED Fairing Indicators

Upgrade bulb type OEM fairing indicators with these clear lens versions featuring LED's

Make / Model Year	Front	Rear
<b>KAWASAKI</b>		
ER6F	06-08 <b>INDK009</b>	N/A
ZX6R/636	05-08 <b>INDK009</b>	N/A
ZX6R/636	09 <b>INDK009</b>	N/A
Z1000	07-09 <b>INDK009</b>	N/A
ZX10R	04-05 <b>INDK003</b>	N/A
ZX10R	06-07 <b>INDK009</b>	<b>INDK006</b>
ZX10R	08 <b>INDK009</b>	N/A
ZZR 1400	06-08 <b>INDK009</b>	<b>INDK006</b>
<b>SUZUKI</b>		
GSX 650F	06-07 <b>INDS018</b>	N/A
GSX 750F	06-07 <b>INDS018</b>	N/A
GSXR 600	06-07 N/A	<b>INDS009</b>
GSXR 600	08-09 N/A	<b>INDS006</b>
GSXR 750	06-07 N/A	<b>INDS009</b>
GSXR 750	08-09 N/A	<b>INDS006</b>
GSXR 1000	05-06 N/A	<b>INDS009</b>
GSXR 1000	07-08 N/A	<b>INDS006</b>
GSXR 1000	09> N/A	<b>INDS003</b>
GSXR 1300	99-07 <b>INDS012</b>	N/A
GSXR 1350	08> <b>INDS015</b>	N/A



Motorcycle  
Exhausts  
Screens  
Commuter  
Controls  
Headlights  
Indicators  
Mirrors  
Rear Lights  
Lifts & Stands  
Tools  
Batteries & Chargers  
Electrics  
Chain  
Servicing  
Tyres & Tubes  
Security  
Bike Accs  
Luggage  
Rider Accs  
Tank Pads  
Extras

### LED Shard Indicators

**NEW**

Reduced size classic OEM style indicator.  
Super-bright amber LEDs.  
Rubberised mounting stem.  
60mm width.  
E-Marked.

Order Code: **INDLED64**



### LED ORB Indicators

A clean design indicator with transparent lens and inset LEDs.  
Lens dimension: 57mm x 29mm  
E-marked.

**For LED relays see page 125**

Order Code	Description
<b>INDLED40</b>	Black body
<b>INDLED41</b>	Carbon Effect body
<b>INDLED42</b>	Chrome Effect body

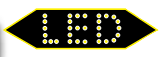

### LED Claw Indicators



A modern angular design indicator with transparent lens and inset LEDs. Features amber side-tip LED for side-on visibility and increased safety.  
Maximum lens dimension: 75mm x 34mm  
E-marked.

**For LED relays see page 125**

Order Code	Description
<b>INDLED38</b>	Black body
<b>INDLED39</b>	Carbon Effect body



### LED Talon Indicators

Bright, fast LED's set into a talon shape indicator body.  
Available in black short or long stem options.  
E-marked.

Order Code	Stem
<b>INDLED30</b>	Short stem
<b>INDLED31</b>	Long stem



**For LED relays see page 125**





## LED Peak Indicators

Contoured shaped mini indicator  
Features amber peak cut-out for greater visibility  
Anti-vibration stem  
Incorporates bright, fast LEDs  
Available in short and long stems  
E-marked

Order Code    Description  
**INDLED49**    Black, short stem



For LED relays  
see page 125



## LED Arrow Indicators

Arrow shaped mini indicator  
Anti-vibration stem  
Incorporates bright, fast LEDs  
E-marked

Order Code: **INDLED48**



For LED relays  
see page 125



## LED Spear Indicators

Bright, fast LED's set in the ever popular  
spear style body.  
Available in short and long stem options.  
E-marked.

Order Code    Description  
**INDLED18**    Long black  
**INDLED19**    Short black  
**INDLED20**    Long carbon  
**INDLED21**    Short carbon



For LED relays  
see page 125

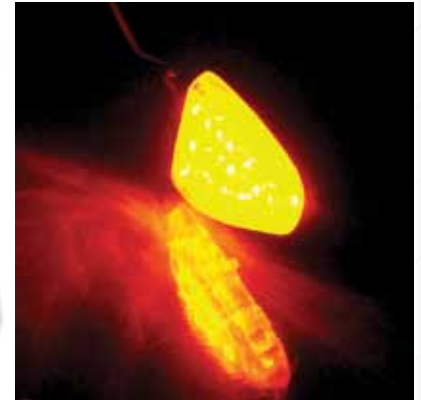

## LED Atom Indicators

These tiny units feature ultra-bright LEDs,  
perfect for use as additional indicators.  
Width: 26mm, height 18mm  
Universal 6mm bolt fitting

Order Code    Colour  
**INDLED32**    Black Body  
**INDLED33**    Chrome Body



For LED relays  
see page 125



Images are  
actual size

MotoGP  
 Exhausts  
 Screens  
 Commuter  
 Controls  
 Headlights  
 Indicators  
 Mirrors  
 Rear Lights  
 Lifts & Stands  
 Tools  
 Batteries & Chargers  
 Electrics  
 Chain  
 Servicing  
 Tyres & Tubes  
 Security  
 Bike Accs  
 Luggage  
 Rider Accs  
 Tank Pads  
 Extras  
 www.bikeit.co.uk

### Midi Axe indicators

Midi size replacement universal indicator.  
8mm bolt fitment.  
Black body with flexi-stem.  
Amber lens.

Order Code: **INDUAXAMB**



### Mini Cat Eye Indicators

E-marked.

Order Code	Body Colour	Lens
<b>INDUCEBLKE</b>	Black	Amber
<b>INDUCEBLKIE</b>	Black	Iridium
<b>INDUCECBNE</b>	Carbon look	Amber
<b>INDUCECBNIE</b>	Carbon look	Iridium
<b>INDUCECHE</b>	Chrome	Amber

**BULBS**

<b>BLB03</b>	12v 23W T8.5/10 BA9S clear (10 pcs)
<b>BLB07</b>	12v 23W T8.5/10 BA9S amber (10 pcs)



### Mini Spear Indicators

E-marked.

Order Code	Body Colour	Stem	Lens
<b>INDULSPEBLK</b>	Black	Long	Amber
<b>INDUSSPEBLK</b>	Black	Short	Amber
<b>INDULSPEBLKI</b>	Black	Long	Iridium
<b>INDUSSPEBLKI</b>	Black	Short	Iridium
<b>INDULSPECBN</b>	Carbon look	Long	Amber
<b>INDUSSPECBN</b>	Carbon look	Short	Amber
<b>INDULSPECBNI</b>	Carbon look	Long	Iridium
<b>INDUSSPECBNI</b>	Carbon look	Short	Iridium

**BULBS**

<b>BLB03</b>	12v 23W T8.5/10 BA9S clear (10 pcs)
<b>BLB07</b>	12v 23W T8.5/10 BA9S amber (10 pcs)



### Slim Fairing Indicators

A simple but unique design. These indicators have a backing nut fitment, simply place the indicator through the fairing's existing or newly cut hole and screw secure. Slim fit fairing indicators fit flush against the fairing, ideal to replace bulky original indicators.

**SMALL OVAL (70mm x 35mm)**

<b>INDFSLSA</b>	Amber lens
<b>INDFSLSS</b>	Smoke lens
<b>INDFSLST</b>	Transparent lens with amber bulb

**BULBS (10 pcs pack)**

<b>BLB09</b>	12v 10w BA9S G11 amber (
<b>BLB03</b>	12v 23w BA9S T8.5/10 clear
<b>BLB07</b>	12v 23w BA9S T8.5/10 amber

**MICRO SLIM (45mm x 40mm)**

<b>INDFSLMA</b>	Amber lens
<b>INDFSLMS</b>	Smoke lens
<b>INDFSLMT</b>	Transparent lens with amber bulb

**BULBS (10 pcs pack)**

<b>BLB03</b>	12v 23w BA9S T8.5/10 clear
<b>BLB07</b>	12v 23w BA9S T8.5/10 amber



MICRO



SMALL





## Universal Indicators

Universal 12v 10w amber lens indicators.  
E-marked.

Order Code	Description
<b>INDUFL012</b>	Flexi-stem 10mm bolt
<b>INDUFL014</b>	Flexi-stem 10mm bolt
<b>INDUFL016</b>	Fixed-stem screw mount



## Universal OEM Indicators

Order Code	Description
<b>INDUFXSCR</b>	Fixed-stem inds screw mount *
<b>INDUFLBOLT</b>	Flexi-stem inds 10mm bolt mount *
<b>INDUFLSCR</b>	Flexi-stem inds screw mount *



\* E-marked Original Equipment product.

## Flexi-Stem Indicators

Universal flexi-stem oval inds 10mm bolt mount \*

Order Code	Description
<b>INDUFLOVAL</b>	Amber Lens
<b>INDUFLCROV</b>	Crystal Lens

\* E-marked Original Equipment product.



## Original Fairing Indicators

E-marked.

Order Code	Body	Lens
<b>INDFBLK</b>	Black	Amber lens
<b>INDFBLKS</b>	Black	Smoked lens
<b>INDFBLKT</b>	Black	Transparent lens
<b>INDFCBN</b>	Carbon	Amber lens
<b>INDFCBNS</b>	Carbon	Smoked lens
<b>INDFCBNT</b>	Carbon	Transparent lens

### BULBS

<b>BLB04</b>	12v 23w G18.5 BA15S clear (10pcs)
<b>BLB08</b>	12v 10w G18.5 BA15S amber (10pcs)



Motocp  
Exhausts  
Screens  
Commuter  
Controls  
Headlights  
Indicators  
Mirrors  
Rear Lights  
Lifts & Stands  
Tools  
Batteries & Chargers  
Electrics  
Chain  
Servicing  
Tyres & Tubes  
Security  
Bike Accs  
Luggage  
Rider Accs  
Tank Pads  
Extras

MotoGP  
 Exhausts  
 Screens  
 Commuter  
 Controls  
 Headlights  
 Indicators  
 Mirrors  
 Rear Lights  
 Lifts & Stands  
 Tools  
 Batteries & Chargers  
 Electrics  
 Chain  
 Servicing  
 Tyres & Tubes  
 Security  
 Bike Accs  
 Luggage  
 Rider Accs  
 Tank Pads  
 Extras

## Shard Indicators

**NEW**

Reduced size classic OEM style indicator.  
 H6W Super-bright bulbs.  
 Rubberised mounting stem.  
 60mm width.  
 E-Marked.

Order Code: **INDSRD12**



## Arrow Indicators

Cool Arrow shaped mini indicators. These feature a cut-out on the reverse side which allows the indicator beam to be visible from front and back. Increased safety and great looking too. Supplied with 12v 23w BA9S bulbs. E-marked.

Order Code Description  
**INDARRBK** Black body, clear lens  
**INDARRCBN** Carbon body, clear lens

**BULBS**  
 Order Code Description  
**BLB07** 12v 23w BA9S bulbs (10 pieces)



## Mini Indicators

The "original" replacement mini indicator. Classic design in short and long stems with a variety of colours.

**BULBS**  
**BLB03** 12v 23w BA9S T8.5/10 clear / 10pcs  
**BLB07** 12v 23w BA9S T8.5/10 amber / 10pcs

Order Code Body Colour Stem Lens  
**INDMLBLK** Black Long Amber  
**INDMLBLKS** Black Long Smoked  
**INDMLBLKT** Black Long Transparent

Order Code Body Colour Stem Lens  
**INDMSBLK** Black Short Amber  
**INDMSBLKS** Black Short Smoked  
**INDMSBLKT** Black Short Transparent

**INDMLCBN** Carbon Long Amber  
**INDMLCBNS** Carbon Long Smoked  
**INDMLCBNT** Carbon Long Transparent  
**INDMLCH** Chrome Long Amber

**INDMSCBN** Carbon Short Amber  
**INDMSCBNS** Carbon Short Smoked  
**INDMSCBNT** Carbon Short Transparent  
**INDMSCH** Chrome Short Amber



## Crystal Fairing Indicators

A universal full lens fairing indicator offering all-round visibility from front, side and rear of the bike. Excellent safety in a great design, the lens has the ever-popular iridium colouring. Fitted with 12v 23w bulbs and iridium lenses.

Order Code: **INDFCRY**





## Torch Indicators

Zinc alloy bodied in chrome or black finish  
 Classic styling 82mm(W) x 22mm(H)  
 Amber lens with 12V/21W bulb  
 Anti-vibration rubbers  
 E-marked

Order Code	Description
<b>INDTORBLK</b>	Black
<b>INDTORCH</b>	Chrome



## Mini Custom Indicators

Order Code	Description
<b>INDCS</b>	Short stem 5 cm
<b>INDCL</b>	Long stem 7 cm
<b>INDCX</b>	XL stem 10cm



## Bullseye Indicators

Order Code	Description
<b>INDCB22</b>	22mm bar end mount (1 pc) Stem OD = 18mm
<b>INDCB25</b>	25mm bar end mount (1 pc) Stem OD = 21mm



Replacement Clear Bulb  
 Order Code: **BLB46**

## Bull's Eye Indicators With Clear Lens

Each item contains 1 Bull's Eye bar end indicator with original amber lens/clear bulb. Also included is a clear lens conversion kit (2 clear lenses and 1 amber bulb) to allow quick and simple change of lens / bulb colour. Available in 22mm and 25mm bar fitment

Order Code	Description
<b>INDCB22TR</b>	22mm fitment Stem OD = 18mm
<b>INDCB25TR</b>	25mm fitment Stem OD = 21mm

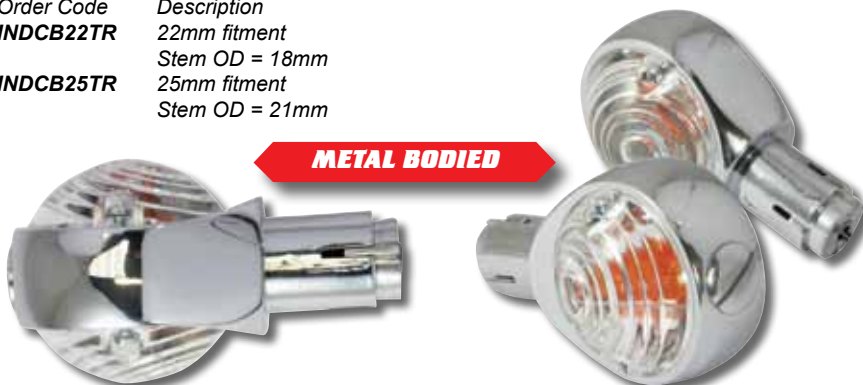

## Amber Bulb Conversion Kit

**Clear Lens / Amber bulb conversion kit**  
 Each kit contains 2 clear lenses and 1 amber bulb, to convert 1 Bull's Eye indicator from the original amber lens configuration.  
 Order Code: **INDCBKITTR**

**Replacement Amber Bulb**  
 12v 18w replacement amber bulb for Bull's Eye Indicator  
 Order Code: **BLB44**



Motocp  
 Exhausts  
 Screens  
 Commuter  
 Controls  
 Headlights  
 Indicators  
 Mirrors  
 Rear Lights  
 Lifts & Stands  
 Tools  
 Batteries & Chargers  
 Electrics  
 Chain  
 Servicing  
 Tyres & Tubes  
 Security  
 Bike Accs  
 Luggage  
 Rider Accs  
 Tank Pads  
 Extras

### Bullet Indicators

Machined metal bodied indicators in long and short stem options. Universal bolt fitment.

Order Code	Description
INDCBU	Chrome, short stem
INDC011	Chrome, long stem
INDC015	Black, short stem



**METAL BODIED**



### Eagle Eye Indicators

'Eagle Eye' shaped indicators, high quality machined and polished metal body, 12v 21w bulb. Available in black body.

E-marked.  
Width = 95mm, height = 30mm

**METAL BODIED**

Order Code: **INDEAGBLK**



### Adjustable Stem Indicators

Machined metal bodied indicators with adjustable stem. Universal bolt fitment.

Order Code	Colour
INDUADJALL	Alloy
INDUADJBLK	Black
INDCADJ	Chrome

**METAL BODIED**





## Clamp Type Indicators

Machined metal bodied indicators in a high chrome finish. Universal clamp fitment.

Order Code	Description
<b>INDCRC</b>	Round
<b>INDCSC</b>	Square

**METAL BODIED**



## Maltese Cross Indicator / Marker Lights

Maltese Cross shape indicator/marker light, fits flush to fairings and bodywork. This has a simple plastic backing nut fitment, securing around the bulb housing. Pair.

12v 10w amber bulb

Order Code: **INDUMTC09**

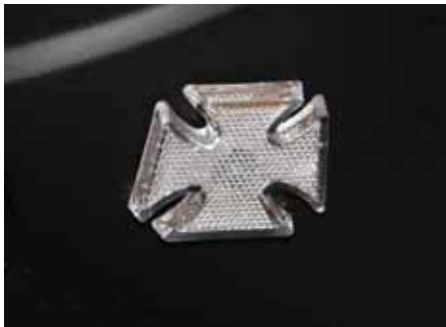

## Shark Head Indicators

Uniquely shaped Shark-Head indicators. The bodies are machined alloy with a super high quality finish. Includes super bright H4 bulbs. Available in Alloy and Black finishes with amber lenses. Supplied with H21w, 12v 21w bulbs. E-marked.

Order Code	Description
<b>INDSHKALL</b>	Alloy body, amber lens
<b>INDSHKBLK</b>	Black body, amber lens

### BULBS

Order Code	Description
<b>BLB28</b>	12v 21w bulbs (10 pieces)

**METAL BODIED**



Motocp  
Exhausts  
Screens  
Commuter  
Controls  
Headlights  
Indicators  
Mirrors  
Rear Lights  
Lifts & Stands  
Tools  
Batteries & Chargers  
Electrics  
Chain  
Servicing  
Tyres & Tubes  
Security  
Bike Accs  
Luggage  
Rider Accs  
Tank Pads  
Extras

MotoGP  
Exhausts  
Screens  
Commuter  
Controls  
Headlights  
Indicators  
Mirrors  
Rear Lights  
Lifts & Stands  
Tools  
Batteries & Chargers  
Electrics  
Chain  
Servicing  
Tyres & Tubes  
Security  
Bike Accs  
Luggage  
Rider Accs  
Tank Pads  
Extras  
www.bikeit.co.uk

## Indicator Connector Leads

Easy and quick solution to fitting aftermarket indicators. Utilise OEM style blocks to connect into the existing wiring. Bullet ended wires plug on to universal indicators. Eliminates need to cut out original wiring. Four shapes available to fit Honda, Kawasaki, Suzuki, Yamaha.

Order Code Description

- ICL001** Honda & Kawasaki
- ICL002** Honda & Kawasaki
- ICL003** Suzuki & Yamaha
- ICL004** Suzuki & Yamaha

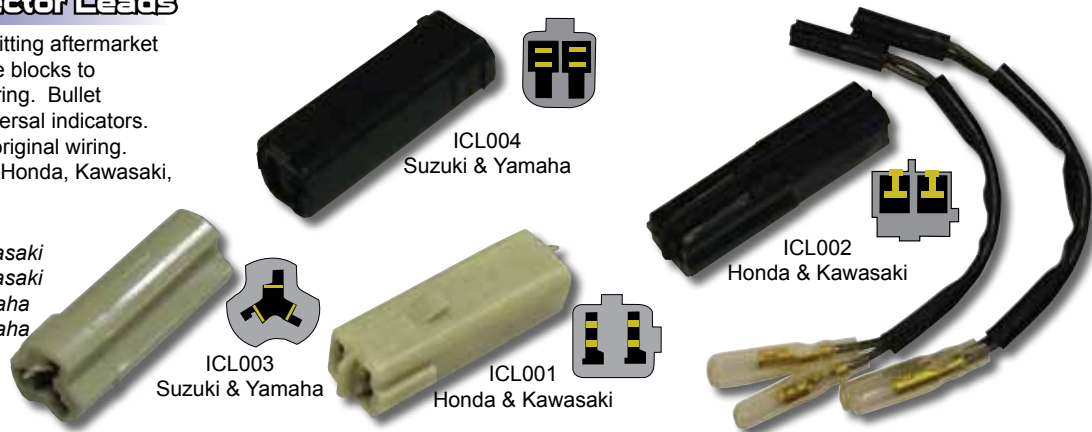

## Indicator Spacers

Bike specific sets of spacers to fill the holes left from removal of original bulky indicators. Sets are available for the front or rear of the bikes shown below, allowing easy and neat installation of aftermarket indicators.

Make / Model	Year	Front	Rear
<b>HONDA</b>			
CBR125R	09>	ISPH03	#
CBR250R	11>	ISPH03	#
CBR600F	99>	ISPH01	ISPH01
CBR600RR	03-06	ISPH01	ISPH01
CBR600RR	07>	ISPH03	#
CBR900RR Fireblade	92-03	ISPH01	ISPH01
CB600/900 Hornet	>01	ISPH02	ISPH02
CB600/900 Hornet	02>	ISPH01	ISPH01
CBR1000RR	04-07	ISPH01	ISPH01
VTR1000 SP1 / SP2	00-06	ISPH01	ISPH01
CBR1100XX	97-07	#	ISPH01
CB1300S	05-09	ISPH01	#

<b>KAWASAKI</b>			
ZX6-R/RR	98-04	ISPK01	ISPK01
ZX6-R/RR	05-06	ISPK02	#
ZX7-R	96-03	ISPK01	ISPK01
ZR-7S	03>	ISPK01	ISPK01
ZX9-R	98-03	ISPK01	ISPK01
ZX12-R	00-05	ISPK01	ISPK01
ZRX1200S	03>	ISPK01	ISPK01

<b>SUZUKI</b>			
GSXR600 / 750	96-02	ISPS01	ISPH02
GSXR600/750/1000	01-05	ISPH02	ISPH02
GSF600/1200(S)	01>	ISPH02	ISPH02
Bandit			
SV650S	00-07	ISPH02	ISPH02
TL1000S	97-02	ISPS01	ISPH02
TL1000R	97-02	ISPH02	#
SV1000S	00>	ISPH02	ISPH02
GSXR1300	99-07	#	ISPH02
Hayabusa			

<b>YAMAHA</b>			
FZ600 Fazer	98-03	ISPY01	ISPY01
FZ6 Fazer	03>	ISPY02	ISPY02
YZF600 Thundercat	96>	#	ISPY01
YZF-R6	99-02	ISPY01	ISPY01
YZF-R6	03-11	ISPY02	ISPY02
FZ1000 Fazer	98-05	ISPY01	ISPY01
FZ1 Fazer	03>	ISPY02	ISPY02
YZF-R1	98-01	ISPY01	ISPY01
YZF-R1	02-11	ISPY02	ISPY02
YZF1000 Thunderace	01	#	ISPY01
FJR1300	98>	ISPY01	#

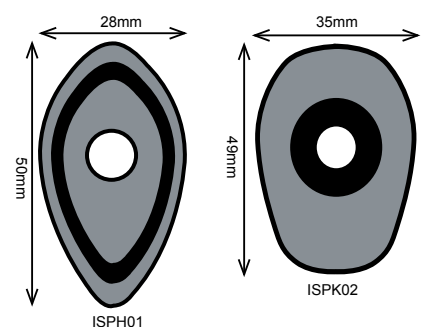
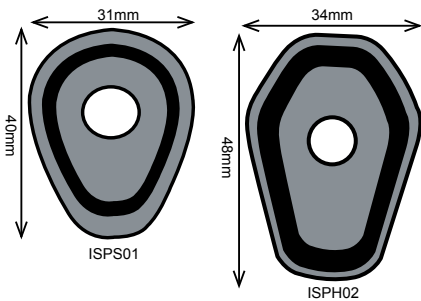
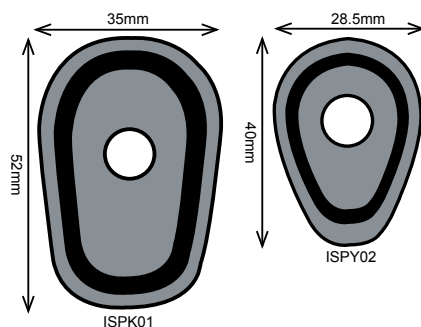
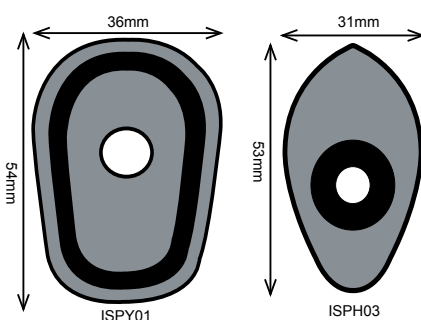

## 127pc Heat Shrink Wire Wrap Assortment

Contains 7 popular sizes, complete with sectioned storage case. When heated, these sleeves shrink around wiring for optimum connection and insulation.

Order Code: **ASST21**



## Scotch Lock Wire Connectors

Push fit connector blocks for easy and tidy connection of electrical wires. Ideal for installing indicators, rear lights etc. Pack of 10 connectors.

Order Code: **ASST24**





## LED Indicator Relays

LED indicators work to a lower wattage than standard bulb-type indicators. To avoid rapid flashing it may be necessary to replace the existing relay with a specially designed LED relay with the correct wattage.

Order Code	Description
<b>WRELED01</b>	2 pin Universal
<b>WRELED02</b>	3 pin Universal
<b>WRELED03</b>	OEM Block type Fits most Honda, Kawasaki, Yamaha
<b>WRELED05</b>	7 pin Suzuki OEM block type, 12V



## LED Indicator Resistor

An easy alternative to installing an LED indicator relay, these resistors are simply connected in series to each indicator, creating correct indicator flash rate without needing to replace the OE relay. Each indicator requires 1 resistor. Sold individually.

Order Code: **WRELED04**



## Indicator Bulbs

Order Code	DESCRIPTION	QTY	BASE	VOLT	WATT	BULB	COLOUR	FOR
<b>BLB03</b>	12v 23w T8.5/ 10 BA9S	10	BA9S	12	23	T8.5/10	Clear	Mini/ spear/ cat eye/ Diamond
<b>BLB04</b>	12v 23w	10	BA15S	12	23	G18.5	Clear	Original fairing
<b>BLB06</b>	12v 10w	10	BA15S	12	10	G18.5mm	Clear	Large slim fairing
<b>BLB07</b>	12v 23w T8.5/ 10 BA9S	10	BA9S	12	23	T8.5/10	Amber	Mini/ spear/ cat eye/ Diamond
<b>BLB08</b>	12v 10w	10	BAY15D	12	10	G18.5mm	Amber	Large slim fairing/ original fairing
<b>BLB09</b>	12v 10w	10	BA9S	12	10	G11	Amber	Small slim fairing
<b>BLB22</b>	12v 10w	10	S8.5	12	10	T10 x 31mm	Clear	Sports mirror indicators
<b>BLB28</b>	12v 21w	10	BAY9S	12	21	T8.5	Clear	Mini/Spear/Shark Head E-marked
<b>BLB31</b>	12v 23w	10	BAY15D	12	23	G18.5	Amber	Crystal fairing
<b>BLB35</b>	12v 10w	1	WEDGE	12	10	T14	Amber	Demon headlight
<b>BLB42</b>	12v 10w	1	WEDGE	12	10	T14	Amber	Aura headlight
<b>BLB44</b>	12v 18w	1	FESTOON	12	18		Amber	Bullseye
<b>BLB46</b>	12v 18w	1	FESTOON	12	18		Clear	Bullseye
<b>BLB47</b>	12v 21w	10	BAY9S	12	21	T8.5	Amber	Mini/Spear/Shark Head E-marked
<b>BLB49</b>	12v 6w	10	BAX9S	12	6		Clear	Shard indicators



## Indicator Relays

### UNIVERSAL

Order Code	V	W	Pins	Size
<b>WRE01*</b>	6	8/10	2	Small
<b>WRE02*</b>	12	8/10	2	Small
<b>WRE03*</b>	6	18/23	2	Small
<b>WRE04*</b>	12	18/23	2	Small
<b>WRE05*</b>	6	18/23	3	Small
<b>WRE06*</b>	12	18/23	3	Small
<b>WRE08</b>	12	18/23	2	Medium
<b>WRE09</b>	6	18/23	2	Large

### OEM

<b>WRE11*</b>	Yamaha DT50
<b>WRE12*</b>	Yamaha TZR125
<b>WRE14*</b>	Honda 12.8v 23(21)x2+3.4w CBR600, CBR900, CBR1100, VFR750, VTR1000 etc

\*Complete with Rubber Holder



MotoCup  
 Exhausts  
 Screens  
 Commuter  
 Controls  
 Headlights  
 Indicators  
 Mirrors  
 Rear Lights  
 Lifts & Stands  
 Tools  
 Batteries & Chargers  
 Electrics  
 Chain  
 Servicing  
 Tyres & Tubes  
 Security  
 Bike Accs  
 Luggage  
 Rider Accs  
 Tank Pads  
 Extras

## Universal Mirrors - Fairing Fitment



40mm stem short

110mm stem long



110mm stem long

40mm stem short

Carbon Look F1  
**MRUF1CBNL (PAIR) LONG**  
**MRUF1CBNS (PAIR) SHORT**

Black F1  
**MRUF1BLKL (PAIR) LONG**  
**MRUF1BLKS (PAIR) SHORT**

Black  
F3 mirrors fairing fitment (PAIR)  
**MRUF3FRBLK**

Carbon look  
F3 mirrors fairing fitment (PAIR)  
**MRUF3FRCBN**



Trojan Universal fairing type  
2 bolt fixing, adjustable from 24mm - 68mm (PAIR)  
**MRU011**



Adjustable

Black FAIRING  
**MRUFBLK (PAIR)**

Black  
Universal "STALKER" fairing type (PAIR)  
**MRUSTKFRBLK**

Carbon look  
Universal "STALKER" fairing type (PAIR)  
**MRUSTKFRCBN**

## Universal Mirrors - Custom Chrome



Husky oval chrome 10mm stem. (PAIR)  
**MRU004**

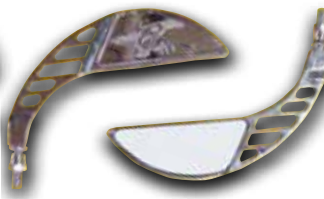

Vixen high chrome mirrors with detail engraved design. 10mm stem. (PAIR)  
**MRU005**



Knight rectangular chrome 10mm stem. (PAIR)  
**MRU009**



Phantom oval chrome 10mm stem. (PAIR)  
**MRU007**



Runner rectangular chrome 10mm stem. (PAIR)  
**MRU008**



Shift oval chrome machined 10mm stem. (PAIR)  
**MRU010**



Highway mirrors - Bar end fitment (PAIR)  
**MRU021**



Maltese Cross, 10mm stem (PAIR)  
**MRU024**



Universal high-chrome mirrors (PAIR).  
**MRU027**



Universal high-chrome mirrors (PAIR).  
**MRU028**

Motocp  
Exhausts  
Screens  
Commuter  
Controls  
Headlights  
Indicators  
MIRRORS  
Rear Lights  
Lifts & Stands  
Tools  
Batteries & Chargers  
Electrics  
Chain  
Servicing  
Tyres & Tubes  
Security  
Bike Accs  
Luggage  
Rider Accs  
Tank Pads  
Extras  
www.bikeit.co.uk



## Universal Mirrors - with LED Indicators

Simply wire the mirrors into the existing indicator circuit. Not intended as replacements for indicators!



Patrol teardrop mirror with inbuilt LED secondary indicator. 10mm stem. (PAIR)  
**MRU003 Chrome**

Patrol teardrop mirror with inbuilt LED secondary indicator. 10mm stem. (PAIR)  
**MRU006 Black**

Universal fairing mirrors with LED indicators, 50mm spacing on base. (PAIR)  
**MRUSPIND**



Trojan Universal bar mounted, 10mm stem In-built LED indicators (PAIR)  
**MRU015**

Trojan Universal fairing type 2 bolt fixing, adjustable from 24mm - 68mm In-built LED indicators (PAIR)  
**MRU014**

## Universal Mirrors - Bar End & Bar Fitment



Phoenix bar-end mirrors  
**MRU025 (PAIR) - Black**

Phoenix bar-end mirrors  
**MRU026 (PAIR) - Alloy**

Bar End Mount Mirror  
Black casing, alloy stem  
**MRU020**



Mini folding - 7/8" bar fitting  
**MRU001L LEFT**  
**MRU001R RIGHT**

CHROME BAR END  
**MRUBARCH (L/R)**  
BLACK BAR END  
**MRUBARBLK (L/R)**

8mm MOPED CLAMP-ON  
**MRU64510 (PAIR)**

## Universal Mirrors - Bolt Fitment



Black  
F3 mirrors handlebar fit 10mm (PAIR)  
**MRUF3HBLK**

Carbon look  
F3 mirrors handlebar fit 10mm (PAIR)  
**MRUF3HBCBN**

Black  
Universal "STALKER" handlebar type (PAIR)  
**MRUSTKHBLK 10mm std thread**

Carbon look  
Universal "STALKER" handlebar type (PAIR)  
**MRUSTKHBCBN 10mm std thread**

Motocp  
Exhausts  
Screens  
Commuter  
Controls  
Headlights  
Indicators  
MIRRO  
Rear  
Lights  
Lifts &  
Stands  
Tools  
Batteries &  
Chargers  
Electrics  
Chain  
Servicing  
Tyres &  
Tubes  
Security  
Bike  
Accs  
Luggage  
Rider  
Accs  
Tank  
Pads  
Extras

## Universal Mirrors - Bolt Fitment cont...



AERO MIRROR 8mm and 10mm  
**MRUAERO8** 8mm std thread (PAIR)  
**MRUAERO10** 10mm std thread (PAIR)

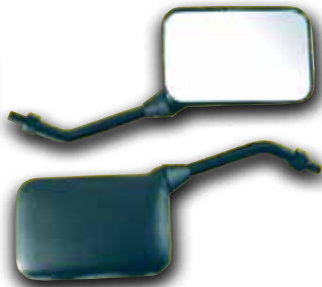

GP SPORTS SHORT, 10mm STD  
**MRUGPS** (PAIR)  
 GP SPORTS LONG, 10mm STD  
**MRUGPL** (PAIR)



Falcon 10mm (PAIR)  
 BLACK  
**MRU029**

"Source" 10mm thread universal mirror.  
 Fully E-marked, suitable for homologation projects. (PAIR)  
**MRU016**



'ELEMENT' 10mm thread  
**MRU017** (PAIR) BLACK



'ELEMENT' 10mm thread  
**MRU018** (PAIR) BLUE



Universal black mirrors  
 10mm stem  
**MRU023** (PAIR)



Universal black mirrors  
 10mm stem  
**MRU022** (PAIR)



Trojan Universal bar mounted  
 10mm stem (PAIR)  
**MRU012**



UNIVERSAL 8mm THREAD  
**MRU64531** (Pair)  
 UNIVERSAL 10mm THREAD  
**MRU64532** (Pair)



MULTI-FUNCTION, FOLDING  
**MRUFOLD** (L/R)



8/10mm THREAD  
 (Removable Knuckle)  
**MRU30650** (L/R)



UNIVERSAL MIRRORS CLASSIC  
 CUSTOM (PAIR)  
**MRUCC10** 10mm std thread.



CUSTOM CRUISER  
**MRUCRU** 10mm std thread (L/R)



MINI CHROME XV TYPE 10mm  
**MRUMCH**



UNIVERSAL SCOOTER  
**MRUSCOOTR** RIGHT  
**MRUSCOOTL** LEFT



'TRUE VISION'  
**MRUTVIS** (PAIR)



8mm THREAD or CLAMP  
**MRU30653** (L/R)

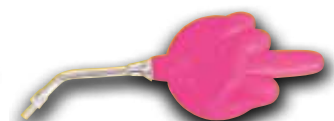

THE FINGER!  
 10mm thread (L/R)  
**MRUFING03** Black  
**MRUFING01** Pink



TWO FINGERS!  
 10mm thread (L/R)  
**MRUFING04** Black

MotoGP  
 Exhausts  
 Screens  
 Commuter  
 Controls  
 Headlights  
 Indicators  
**MIRRORS**  
 Rear Lights  
 Lifts & Stands  
 Tools  
 Batteries & Chargers  
 Electrics  
 Chain  
 Servicing  
 Tyres & Tubes  
 Security  
 Bike Accs  
 Luggage  
 Rider Accs  
 Tank Pads  
 Extras  
 www.bikeit.co.uk



# OEM Replacement Mirrors

A fully comprehensive range of replacement mirrors for Japanese and European road bikes and scooters. Quality and precision manufactured to be direct replacements for OEM mirrors at a fraction of the price.



Model	Year	Left Mirror Order code	Right Mirror Order code	Pair Order code
-------	------	------------------------	-------------------------	-----------------

Aprilia				
Amico 50		MRASR50L	MRASR50R	#
Gulliver 50	97>	MRASR50L	MRASR50R	#
RS50	97>	MRARSVL	MRARSVR	#
SR50		MRASR50L	MRASR50R	#
SR50 / Factory		MRA002L	MRA002R	#
Tuono 50		MRA001L	MRA001R	#
Leonardo 125	>99	MRASR50L	MRASR50R	#
RS125	97>	MRARSVL	MRARSVR	#
SR125		MRASR50L	MRASR50R	#
Tuono 125		MRA001L	MRA001R	#
Leonardo 250	>99	MRASR50L	MRASR50R	#
RS250	97>	MRARSVL	MRARSVR	#
SR250		MRASR50L	MRASR50R	#
RXV450 / 550		MRA003L	MRA003R	#
Pegaso 650		MRA003L	MRA003R	#
Trail 650		MRA003L	MRA003R	#
Shiver 750		MRA003L	MRA003R	#
Mana 850		MRA003L	MRA003R	#
Falco SL1000		MRARSVL	MRARSVR	#
RSV Mille / R		MRARSVL	MRARSVR	#
Tuono 1000		MRA001L	MRA001R	#
Tuono 1000R / Factory		MRA003L	MRA003R	#

BMW				
F650GS		MRB001L	MRB001R	#
F800GS		MRB001L	MRB001R	#

Ducati				
748		MRD001L	MRD001R	#
916		MRD001L	MRD001R	#
996		MRD001L	MRD001R	#
998		MRD001L	MRD001R	#

Gilera				
Runner 50		MRG001L	MRG001R	#
FX125		MRG001L	MRG001R	#
FXR180		MRG001L	MRG001R	#

Honda				
Cub C50 / 70 / 90		#	#	MRU64531
ANF125 Innova	03>	MRH004L	MRH004R	#
ANF125 Innova		MRH003L	MRH003R	#
CB100N		MRHCBXL	MRHCBXR	#
CB125RS		MRHCB125RSL	MRHCB125RSR	#
CBR125R	03-09	MRH012L	MRH012R	#
CBR125R	11-12	MRH009L	MRH009R	#
CG125		MRHCBXL	MRHCBXR	#
CG125	04>	MRH004L	MRH004R	#
MBX125		MRHNS125L	MRHNS125R	#
NS125		MRHNS125L	MRHNS125R	#
NSR125 RP-RS		MRHCBR9L	MRHCBR9R	#
PS125		MRH003L	MRH003R	#
PS125i		MRH004L	MRH004R	#
SH125i / 150i	05-08	MRH003L	MRH003R	#
Scoopy				
CB250N		MRHCBXL	MRHCBXR	#
CBR250		MRHCBR4L	MRHCBR4R	#
CBR250R	11-12	MRH009L	MRH009R	#
CB400N		MRHCBXL	MRHCBXR	#
CBR400		MRHCBR4L	MRHCBR4R	#
VFR400 NC30		MRHCBR4L	MRHCBR4R	#
CB500S		MRH003D	MRH003D	#
CX500		MRHCBXL	MRHCBXR	#
CB600 F2Y		MRHCBR62L	MRHCBR62R	#
Hornet				
CB600 Hornet		MRH003D	MRH003D	#
CB650		#	#	MRHCB650
CBF600	04>	MRH011L	MRH011R	#
CBF600N		MRH005L	MRH005R	#
CBR600	90-97	MRHCBR6L	MRHCBR6R	#
CBR600F	98>	MRHCBR62L	MRHCBR62R	#
CBR600RR	03-12	MRH001L	MRH001R	#

Model	Year	Left Mirror Order code	Right Mirror Order code	Pair Order code
-------	------	------------------------	-------------------------	-----------------

Honda cont...				
Hornet 600		MRH005L	MRH005R	#
Hornet 600	07>	MRH014L	MRH014R	#
CB750		#	#	MRHCB650
RC45	93-99	MRHCBR9L	MRHCBR9R	#
VFR750	89>	MRHCBR6L	MRHCBR6R	#
VFR750	89>	MRHCBR9L	MRHCBR9R	#
VFR800	>98	MRHCBR6L	MRHCBR6R	#
VFR800	99-02	MRHCBR62L	MRHCBR62R	#
VFR800	03-12	MRH008L	MRH008R	#
CB900 Hornet		MRH003D	MRH003D	#
CB900F		#	#	MRHCB650
CBR900RR	92-97	MRHCBR9L	MRHCBR9R	#
CBR900RR	98-03	MRHCBR92L	MRHCBR92R	#
CB1000R		MRH010L	MRH010R	#
CBR1000F		MRHCBR6L	MRHCBR6R	#
CBR1000RR	04-07	MRH001L	MRH001R	#
CBR1000RR	08>	MRH006L	MRH006R	#
VTR1000	02>	MRH002L	MRH002R	#
Firestorm				
VTR1000 SP1	03-07	MRH008L	MRH008R	#
VTR1000 SP2		MRHCBR62L	MRHCBR62R	#
CB1300F		MRH005L	MRH005R	#
CB1300S		MRH007L	MRH007R	#

Italjet				
Jupiter 125 / 150 / 250		MRY002L	MRY002R	#
Millenium		MRASR50L	MRASR50R	#

Kawasaki				
Ninja 250R	08-12	MRK012L	MRK012R	#
GPZ400R		MRKGPZL	MRKGPZR	#
Ninja 400R ABS	11-12	MRK015L	MRK015R	#
ZXR400		MRKZX7L	MRKZX7R	#
EN500		MRKER5D	MRKER5D	#
EN500		MRK002D	MRK002D	#
ER-5		MRKER5D	MRKER5D	#
ER-5		MRK002D	MRK002D	#
GPZ500		MRKGPZL	MRKGPZR	#
GPZ500S		MRKZX7L	MRKZX7R	#
KLE500		MRKER5D	MRKER5D	#
KLE500		MRK002D	MRK002D	#
Zephyr 550 / 750 / 1100		MRKER5D	MRKER5D	#
Zephyr 550 / 750 / 1100		MRK002D	MRK002D	#
Eliminator 600		MRKER5D	MRKER5D	#
Eliminator 600		MRK002D	MRK002D	#
ER6-F	06-08	MRK014L	MRK014R	#
ER6-F	09-12	MRK015L	MRK015R	#
ER6-N	05-08	MRK003L	MRK003R	#
ER6-N	09>	MRK009L	MRK009R	#
GPZ600R		MRKGPZL	MRKGPZR	#
Versys 650	06-09	MRK003L	MRK003R	#
ZX600 D/L	08-12	#	#	MRKZX6
ZX6R F		MRKZX7L	MRKZX7R	#
ZX6R G/J/A	98-03	MRKZX9RL	MRKZX9RR	#
ZX6R / RR	03-04	MRKZX6R03L	MRKZX6R03R	#
ZX6R	05-06	MRK001L	MRK001R	#
ZX6R / RR	07-08	MRK005L	MRK005R	#
ZX6R	09>	MRK007L	MRK007R	#
ZZR600 D/E		MRKZX7L	MRKZX7R	#
ZZR600	90>	MRK004L	MRK004R	#
750 Vulcan		MRKER5D	MRKER5D	#
750 Vulcan		MRK002D	MRK002D	#
Z750	04-06	MRK003L	MRK003R	#
Z750	07-09	MRK009L	MRK009R	#
Z750S	05-07	MRK014L	MRK014R	#
ZX7RR / ZX750		MRKZX7L	MRKZX7R	#
GPZ900		MRKGPZL	MRKGPZR	#
ZX9R C/E		MRKZX9RL	MRKZX9RR	#
GPZ1000		MRKGPZL	MRKGPZR	#
Z1000	03-06	MRK003L	MRK003R	#
Z1000	07-09	MRK009L	MRK009R	#

Motorcycles  
 Exhausts  
 Screens  
 Commuter  
 Controls  
 Headlights  
 Indicators  
 Mirrors  
 Rear Lights  
 Lifts & Stands  
 Tools  
 Batteries & Chargers  
 Electrics  
 Chain  
 Servicing  
 Tyres & Tubes  
 Security  
 Bike Accs  
 Luggage  
 Rider Accs  
 Tank Pads  
 Extras  
 www.bikeit.co.uk

# OEM Replacement Mirrors cont...



Model	Year	Left Mirror Order code	Right Mirror Order code	Pair Order code
-------	------	------------------------	-------------------------	-----------------

### Kawasaki cont...

Z1000 SX	11-12	MRK015L	MRK015R	#
ZX10R	04-08	MRK001L	MRK001R	#
ZX10R	11-12	MRK016L	MRK016R	#
ZRX1200S		MRK010L	MRK010R	#
ZX12R	02-05	MRK011L	MRK011R	#
ZZR1200		MRK010L	MRK010R	#
ZZR1400 / ZX14R	07-09	MRK006L	MRK006R	#
Universal Z-Type		MRKZBLK	MRKZBLK	#

### MBK

Booster		MRYNEOL	MRYNEOR	#
Ovetto		MRYNEOL	MRYNEOR	#
Sprint		MRYNEOL	MRYNEOR	#
Stunt		MRYNEOL	MRYNEOR	#
Flame		MRY010L	MRY010R	#
Cygnus 125R		MRY010L	MRY010R	#
Fizz 50		MRY010L	MRY010R	#
Nitro		MRYARXL	MRYARXR	#

### Peugeot

Elyseo		MRP001L	MRP001R	#
Jet Force		MRP002L	MRP002R	#
Speedake		MRP001L	MRP001R	#
Speedfight	>98	MRP001L	MRP001R	#
Speedfight 50 / 100	98>	MRPSFIGHTL	MRPSFIGHTR	#
Speedfight 100		MRP001L	MRP001R	#
Speedfight 2		MRP002L	MRP002R	#
Trekker		MRPSFIGHTL	MRPSFIGHTR	#
Vivacity		MRPSFIGHTL	MRPSFIGHTR	#
Vivacity		MRP002L	MRP002R	#

### Piaggio / Vespa

ET2 50	>99	MRPET2L	MRPET2R	#
ET4	>00	MRPET2L	MRPET2R	#
ET2 / 4		MRV001L	MRV001R	#
Liberty		MRV002L	MRV002R	#
NRG		MRPNRGL	MRPNRGR	#
Zip		MRPZIPL	MRPZIPR	#

### Suzuki

TS50X		MRS10TS50	MRS10TS50	#
TS50X		MRS8TS50	MRS8TS50	#
Burgman UH125 / 200		MRS005L	MRS005R	#
Epicuro 125/150	01>	MRS012L	MRS012R	#
RV125	07	MRS012L	MRS012R	#
TS125R / X		MRSTS125	MRSTS125	#
Van Van	03-05	MRS012L	MRS012R	#
VL125 / 250		MRS002D	MRS002D	#
Burgman AN250 / 400		MRS008L	MRS008R	#
DR350		MRSTS125	MRSTS125	#
DRZ400 S/SM		MRS012L	MRS012R	#
GSF400 Bandit		MRS002D	MRS002D	#
GSR400		MRS005L	MRS005R	#
GS500F	06-07	MRS007L	MRS007R	#
DL650		MRS014L	MRS014R	#
DR650 R/S		MRS012L	MRS012R	#
GSF600 Bandit		MRS002D	MRS002D	#
GSF600S		MRS009L	MRS009R	#
GSR600		MRS005L	MRS005R	#
GSR600	08-12	MRS011L	MRS011R	#
GSX600F	>97	MRS011L	MRS011R	#
GSX600F	88-97	MRSGXRF	MRSGXRFR	#
Katana		MRSKATL	MRSKATR	#
GSX600F	98-02	MRSGSX7L	MRSGSX7R	#
Katana				
GSF650 / S		MRS005L	MRS005R	#
Bandit				
GSF650 S/SA	05-07	MRS010L	MRS010R	#
Bandit 650	09-11	MRS011L	MRS011R	#
GSXR600	96-00	MRSGXR6L	MRSGXR6R	#
GSXR600	96-00	MRSGXRCBNL	MRSGXRCBNR	#

Model	Year	Left Mirror Order code	Right Mirror Order code	Pair Order code
-------	------	------------------------	-------------------------	-----------------

### Suzuki cont...

GSXR600	01-02	MRSGSX13BLKL	MRSGSX13BLKR	#
GSXR600	02-03	MRSGXR02BLKL	MRSGXR02BLKR	#
GSXR600	04-05	MRS006L	MRS006R	#
GSXR600	06-11	MRS003L	MRS003R	#
GSXR600	12>	MRS015L	MRS015R	#
RF600 / 900		MRSGXR6L	MRSGXR6R	#
RF600 / 900		MRSGXRCBNL	MRSGXRCBNR	#
SV650		MRS004L	MRS004R	#
SV650S	03>	MRS007L	MRS007R	#
SV650S / SA	06-07	MRSGXR02BLKL	MRSGXR02BLKR	#
V-Strom 650		MRS014L	MRS014R	#
XF650 Freewind		MRS014L	MRS014R	#
GSR750 ABS	10-12	MRS016L	MRS016R	#
GSX750		MRS004L	MRS004R	#
GSX750F	>97	MRSGXRF	MRSGXRFR	#
GSX750F	88-97	MRSKATL	MRSKATR	#
Katana				
GSX750F	98>	MRSGSX7L	MRSGSX7R	#
Katana				
GSXR750 G	85-87	#	#	MRSGXR750
GSXR750 J/K	88-89	MRSGXR750FL	MRSGXR750FR	#
GSXR750	90-99	MRSGXR6L	MRSGXR6R	#
GSXR750	90-99	MRSGXRCBNL	MRSGXRCBNR	#
GSXR750	00-02	MRSGSX13BLKL	MRSGSX13BLKR	#
GSXR750	02-03	MRSGXR02BLKL	MRSGXR02BLKR	#
GSXR750	04-05	MRS006L	MRS006R	#
GSXR750	06-10	MRS003L	MRS003R	#
GSXR750	11>	MRS015L	MRS015R	#
VZ800		MRS002D	MRS002D	#
B-King		MRS005L	MRS005R	#
DL1000		MRS014L	MRS014R	#
GSXR1000	89-00	MRSGXR750FL	MRSGXR750FR	#
GSXR1000	01-02	MRSGSX13BLKL	MRSGSX13BLKR	#
GSXR1000	01-02	MRSGXR02BLKL	MRSGXR02BLKR	#
GSXR1000	03-04	MRS007L	MRS007R	#
GSXR1000	05-08	MRS003L	MRS003R	#
GSXR1000	09>	MRS015L	MRS015R	#
SV1000		MRS004L	MRS004R	#
SV1000S	06	MRS007L	MRS007R	#
SV1000S	06-07	MRSGXR02BLKL	MRSGXR02BLKR	#
TL1000 R/S	97-02	MRSGXR6L	MRSGXR6R	#
TL1000 R/S	97-02	MRSGXRCBNL	MRSGXRCBNR	#
V-Strom 1000		MRS014L	MRS014R	#
GSXR1100 G	86-88	#	#	MRSGXR750
GSXR1100	89-96	MRSGXR6L	MRSGXR6R	#
GSXR1100	89-96	MRSGXRCBNL	MRSGXRCBNR	#
GSF1200 Bandit		MRS002D	MRS002D	#
GSF1200S	>05	MRS009L	MRS009R	#
GSF1200S	06>	MRS010L	MRS010R	#
GSX1200		MRS004L	MRS004R	#
Bandit 1250S	06-07	MRS010L	MRS010R	#
ABS				
GSX1300		MRS005L	MRS005R	#
GSXR1300	99>	MRSGSX13BLKL	MRSGSX13BLKR	#
GSX1400		MRS004L	MRS004R	#

### Yamaha

Aerox YQ50		MRYARXL	MRYARXR	#
Booster		MRYNEOL	MRYNEOR	#
Bump		MRYNEOL	MRYNEOR	#
Jog		MRYNEOL	MRYNEOR	#
Neos		MRYNEOL	MRYNEOR	#
Next		MRYNEOL	MRYNEOR	#
Nitro 50 / 100		MRYARXL	MRYARXR	#
Ovetto		MRYNEOL	MRYNEOR	#
Spy 50		MRYNEOL	MRYNEOR	#
BW's 100		MRY014L	MRY014R	#
Cygnus 125R		MRY010L	MRY010R	#
Maxster 125 / 250		MRYMXSL	MRYMXSR	#
RD125LC		MRYRDL	MRYRDR	#
RD125LC		MRYXJL	MRYXJR	#
TZR125		MRYXJL	MRYXJR	#
TZR125 / 250		MRYTZRL	MRYTZRR	#
YBR125	05>	MRY004L	MRY004R	#
YZF-R125	>07	MRY008L	MRY008R	#

MotoGP  
 Exhausts  
 Screens  
 Commuter  
 Controls  
 Headlights  
 Indicators  
**MIRROCS**  
 Rear Lights  
 Lifts & Stands  
 Tools  
 Batteries & Chargers  
 Electrics  
 Chain  
 Servicing  
 Tyres & Tubes  
 Security  
 Bike Accs  
 Luggage  
 Rider Accs  
 Tank Pads  
 Extras  
 www.bikeit.co.uk



## OEM Replacement Mirrors cont...

Model	Year	Left Mirror Order code	Right Mirror Order code	Pair Order code
<b>Yamaha cont...</b>				
YZF-R 125	08-12	MRY023L	MRY023R	#
RD250LC		MRYRDL	MRYRDR	#
YP250 Majesty	96-04	MRY002L	MRY002R	#
Versity XC300		MRYMXSL	MRYMXSR	#
YP400 Majesty	04>	MRY002L	MRY002R	#
T-Max	>07	MRY016L	MRY016R	#
T-Max	08-11	MRY018L	MRY018R	#
T-Max	12>	MRY025L	MRY025R	#
XV535 Virago		MRY015L	MRY015R	#
FZ600		MRYTZRL	MRYTZRR	#
FZR600	89-95	MRYFZR6L	MRYFZR6R	#
FZS600 Fazer	02>	MRY001L	MRY001R	#
FZS600 Fazer	98-01	MRYR1L	MRYR1R	#
FZ-6 Fazer	04>	MRY011L	MRY011R	#
FZ6 Fazer S2 ABS	08-11	MRY024L	MRY024R	#
SV650		MRY015L	MRY015R	#
XJ6	>12	MRY021L	MRY021R	#
XJ6 Diversion	10-12	MRY022L	MRY022R	#
XJ600		MRYXJL	MRYXJL	#
XJ600S		MRY010L	MRY010R	#
XT660 X/R		MRY004L	MRY004R	#
XVS650		MRY015L	MRY015R	#
YZF600 Thundercat	96-02	MRYZF6L	MRYZF6R	#
YZF-R6	98-01	MRYR1L	MRYR1R	#
YZF-R6	98-01	MRYTACEL	MRYTACER	#
YZF-R6	01-02	MRYR12L	MRYR12R	#
YZF R6	03-05	MRY012L	MRY012R	#
YZF-R6	06-07	MRY005L	MRY005R	#
YZF-R6	08>	MRY007L	MRY007R	#
YZF750		MRYZF6L	MRYZF6R	#
FZ8N	10-12	MRY021L	MRY021R	#
TDM850	>99	MRYTDM L	MRYTDM R	#
TDM850	00>	MRY002L	MRY002R	#
TRX800/850		MRYZF6L	MRYZF6R	#

Model	Year	Left Mirror Order code	Right Mirror Order code	Pair Order code
<b>Yamaha cont...</b>				
TDM900		MRY002L	MRY002R	#
XJ900		MRYXJL	MRYXJL	#
XJ900S		MRY010L	MRY010R	#
FZ1 ABS	>08	MRY019L	MRY019R	#
FZR1000		MRYZF6L	MRYZF6R	#
FZS1000 Fazer	01>	MRY001L	MRY001R	#
MT-01	>07	MRY019L	MRY019R	#
YZF1000 Thunderace	98-03	MRYTACEL	MRYTACER	#
YZF-R1	98-99	MRYR1L	MRYR1R	#
YZF-R1	98-99	MRYTACEL	MRYTACER	#
YZF-R1	00-03	MRYR12L	MRYR12R	#
YZF R1	04-05	MRY012L	MRY012R	#
YZF-R1	06-08	MRY006L	MRY006R	#
YZF R1	09-12	MRY020L	MRY020R	#
FJ1100		MRYXJL	MRYXJL	#
FJR1300		MRY017L	MRY017R	#
Royal Star		MRYVMAXL	MRYVMAXR	#
V-Max		MRYVMAXL	MRYVMAXR	#
XJR1300		#	#	MRY009
XJR300		MRY015L	MRY015R	#
XVS1300		MRY015L	MRY015R	#
XJR1400		#	#	MRY009
Universal Aero		#	#	MRYAERO
Universal Aero		#	#	MRYAERO8
Universal Black Plastic		MRY64531	MRY64531	#
Universal Classic Custom		#	#	MRYCC10
Universal Custom Cruiser		MRYCRU	MRUCRU	#
Universal F3 Black		#	#	MRYF3HBLK
Universal F3 Carbon Look		#	#	MRYF3HBCBN
Universal GP Sport		#	#	MRYGPLNG

## Aprilia



MRARSVR  
MRARSVL

RIGHT  
LEFT



MRASR50R  
MRASR50L

RIGHT  
LEFT



MRA001R  
MRA001L

RIGHT  
LEFT

10mm



MRA002R  
MRA002L

RIGHT  
LEFT



MRA003R  
MRA003L

RIGHT  
LEFT

10mm

Motorcycle  
Exhausts  
Screens  
Commuter  
Controls  
Headlights  
Indicators  
Mirrors  
Rear Lights  
Lifts & Stands  
Tools  
Batteries & Chargers  
Electrics  
Chain  
Servicing  
Tyres & Tubes  
Security  
Bike Accs  
Luggage  
Rider Accs  
Tank Pads  
Extras

**BMW**



10mm

MRB001R      RIGHT  
 MRB001L      LEFT

**Ducati**



MRD001R      RIGHT  
 MRD001L      LEFT

**Gilera**



MRG001R      RIGHT  
 MRG001L      LEFT

**Honda**



MRU64531 (PAIR) 8mm

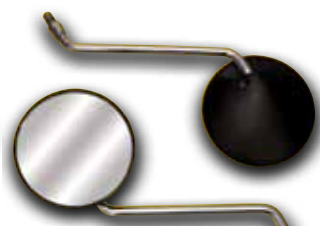

10mm

MRHCBCXR      RIGHT  
 MRHCBCXL      LEFT



10mm

MRHCB125RSR      RIGHT  
 MRHCB125RSL      LEFT



10mm

MRH004R      RIGHT  
 MRH004L      LEFT

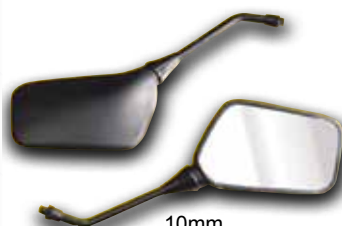

10mm

MRHNS125R      RIGHT  
 MRHNS125L      LEFT



MRH003R      RIGHT 8mm reverse  
    thread  
 MRH003L      LEFT 8mm  
    thread



MRHCBR4R      RIGHT  
 MRHCBR4L      LEFT

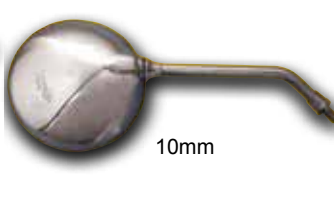

10mm

MRH003D      LEFT or RIGHT



10mm

MRHCB650 (PAIR)



140mm stem

MRHCBR6R      RIGHT  
 MRHCBR6L      LEFT



90mm stem

MRHCBR62R      RIGHT  
 MRHCBR62L      LEFT



MRH001R      RIGHT  
 MRH001L      LEFT



**Honda cont...**



**MRH002R** RIGHT  
**MRH002L** LEFT



75mm stem

**MRHCBR92R** RIGHT  
**MRHCBR92L** LEFT



120mm stem

**MRHCBR9R** RIGHT  
**MRHCBR9L** LEFT



10mm

**MRH005R** RIGHT  
**MRH005L** LEFT



With inds

**MRH006R** RIGHT  
**MRH006L** LEFT



**MRH007R** RIGHT  
**MRH007L** LEFT



10mm

**MRH012R** RIGHT  
**MRH012L** LEFT



10mm

**MRH014R** RIGHT  
**MRH014L** LEFT



**MRH008R** RIGHT  
**MRH008L** LEFT



**MRH009R** RIGHT  
**MRH009L** LEFT



**MRH010R** RIGHT  
**MRH010L** LEFT



**MRH011R** RIGHT  
**MRH011L** LEFT

**Italjet**



**MRY002R** RIGHT  
**MRY002L** LEFT



**MRASR50R** RIGHT  
**MRASR50L** LEFT

**Kawasaki**



**MRKZX6 (PAIR)**

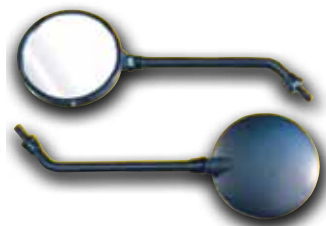

**MRKZBLK** LEFT or RIGHT



**MRKGPZR** RIGHT  
**MRKGPZL** LEFT



**MRKZX7R** RIGHT  
**MRKZX7L** LEFT

Motocp  
Exhausts  
Screens  
Commuter  
Controls  
Headlights  
Indicators  
MIRORS  
Rear Lights  
Lifts & Stands  
Tools  
Batteries & Chargers  
Electrics  
Chain  
Servicing  
Tyres & Tubes  
Security  
Bike Accs  
Luggage  
Rider Accs  
Tank Pads  
Extras

**Kawasaki cont...**

MRKZX9RR MRKZX9RL	MRKZX6R03R MRKZX6R03L	MRK001R MRK001L	MRK003R MRK003L
RIGHT LEFT	RIGHT LEFT	RIGHT LEFT	RIGHT LEFT
MRK004R MRK004L	MRKER5D	MRK002D	MRK005L MRK005R
RIGHT LEFT	LEFT or RIGHT	LEFT or RIGHT	LEFT RIGHT
MRK006L MRK006R	MRK009L MRK009R	MRK007L MRK007R	MRK010L MRK010R
LEFT RIGHT	10mm LEFT RIGHT	LEFT RIGHT	LEFT RIGHT
MRK016R MRK016L	MRK015R MRK015L	MRK014R MRK014L	MRK012R MRK012L
With inds RIGHT LEFT	RIGHT LEFT	RIGHT LEFT	RIGHT LEFT
MRK011R MRK011L			
RIGHT LEFT			

Motocp  
Exhausts  
Screens  
Commuter  
Controls  
Headlights  
Indicators  
MIRRORS  
Rear Lights  
Lifts & Stands  
Tools  
Batteries & Chargers  
Electrics  
Chain  
Servicing  
Tyres & Tubes  
Security  
Bike Accs  
Luggage  
Rider Accs  
Tank Pads  
Extras



## MBK



10mm

**MRYNEOR**  
**MRYNEOL**

**RIGHT**  
**LEFT**



10mm

**MRY010R**  
**MRY010L**

**RIGHT**  
**LEFT**

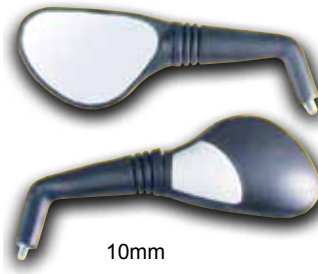

10mm

**MRYARXR**  
**MRYARXL**

**RIGHT**  
**LEFT**

## Peugeot



8mm

**MRP001R**  
**MRP001L**

**RIGHT**  
**LEFT**



**MRPSFIGHTR**  
**MRPSFIGHTL**

**RIGHT**  
**LEFT**



8mm

**MRP002R**  
**MRP002L**

**RIGHT**  
**LEFT**

## Piaggio



8mm

**MRPZIPR**  
**MRPZIPL**

**RIGHT**  
**LEFT**



**MRPET2R**  
**MRPET2L**

**RIGHT**  
**LEFT**



**MRPNRGR**  
**MRPNRGL**

**RIGHT**  
**LEFT**



**MRV001R**  
**MRV001L**

**RIGHT**  
**LEFT**



**MRV002R**  
**MRV002L**

**RIGHT**  
**LEFT**

## Suzuki



**MRS8TS50 (8mm)** LEFT or RIGHT  
**MRS10TS50 (10mm)** LEFT or RIGHT

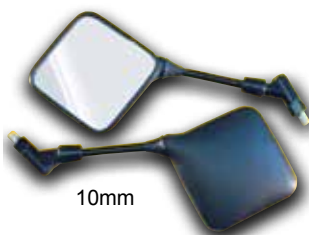

10mm

**MRSTS125**

LEFT or RIGHT

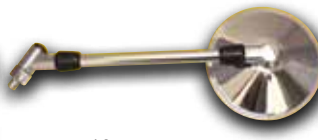

10mm

**MRS002D**

LEFT or RIGHT



**MRSKATR**  
**MRSKATL**

**RIGHT**  
**LEFT**

Motocp  
Exhausts  
Screens  
Commuter  
Controls  
Headlights  
Indicators  
MIRORS  
Rear Lights  
Lifts & Stands  
Tools  
Batteries & Chargers  
Electrics  
Chain  
Servicing  
Tyres & Tubes  
Security  
Bike Accs  
Luggage  
Rider Accs  
Tank Pads  
Extras

**Suzuki cont...**



**MRS GSX6FR** RIGHT  
**MRS GSX6FL** LEFT



**MRS GSX7R** RIGHT  
**MRS GSX7L** LEFT



**MRS GSXR750 (PAIR)**



**MRS GSXR750FR** RIGHT  
**MRS GSXR750FL** LEFT

Fairing Type



**MRS GSXR6R** RIGHT  
**MRS GSXR6L** LEFT

Black



**MRS GSXRCBNR** RIGHT  
**MRS GSXRCBNL** LEFT

CARBON FIBRE EFFECT



**MRS GSX13BLKR** RIGHT  
**MRS GSX13BLKL** LEFT



**MRS GSXR02BLKR** RIGHT  
**MRS GSXR02BLKL** LEFT



**MRS 003R** RIGHT  
**MRS 003L** LEFT

BUILT IN INDICATORS



**MRS 004R** RIGHT  
**MRS 004L** LEFT

10mm



**MRS 005R** RIGHT  
**MRS 005L** LEFT

10mm



**MRS 006R** RIGHT  
**MRS 006L** LEFT



**MRS 007R** RIGHT  
**MRS 007L** LEFT



**MRS 008R** RIGHT  
**MRS 008L** LEFT

10mm



**MRS 009R** RIGHT  
**MRS 009L** LEFT



**MRS 010R** RIGHT  
**MRS 010L** LEFT



**MRS 011R** RIGHT  
**MRS 011L** LEFT

10mm



**MRS 012R** RIGHT  
**MRS 012L** LEFT

10mm



**MRS 014R** RIGHT  
**MRS 014L** LEFT

10mm



**MRS 015R** RIGHT  
**MRS 015L** LEFT

With inds

Motocp  
Exhausts  
Screens  
Commuter  
Controls  
Headlights  
Indicators  
MIRRORS  
Rear Lights  
Lifts & Stands  
Tools  
Batteries & Chargers  
Electrics  
Chain  
Servicing  
Tyres & Tubes  
Security  
Bike Accs  
Luggage  
Rider Accs  
Tank Pads  
Extras  
www.bikeit.co.uk



**Suzuki cont...**



**MRS016R** RIGHT  
**MRS016L** LEFT

**Yamaha**

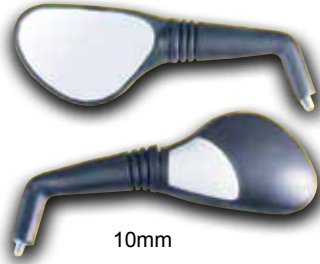

10mm

**MRYARXR** RIGHT  
**MRYARXL** LEFT

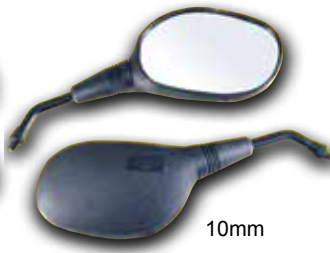

10mm

**MRYNEOR** RIGHT  
**MRYNEOL** LEFT



10mm

**MRY004R** RIGHT  
**MRY004L** LEFT



**MRYTZRR** RIGHT  
**MRYTZRL** LEFT

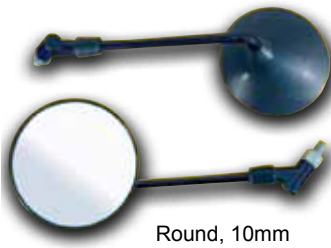

Round, 10mm

**MRYRDR** RIGHT  
**MRYRDL** LEFT

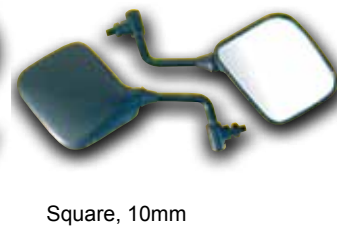

Square, 10mm

**MRYXJR** RIGHT  
**MRYXJL** LEFT



**MRYYZF6R** RIGHT  
**MRYYZF6L** LEFT



**MRYFZR6R** RIGHT  
**MRYFZR6L** LEFT



**MRYTDMR** RIGHT  
**MRYTDML** LEFT



**MRYVMXR** RIGHT  
**MRYVMXL** LEFT



**MRYMXSR** RIGHT  
**MRYMXSL** LEFT



**MRY001R** RIGHT  
**MRY001L** LEFT



130mm stem

**MRYR1R** RIGHT  
**MRYR1L** LEFT



**MRYR12R** RIGHT  
**MRYR12L** LEFT



80mm stem

**MRYTACER** RIGHT  
**MRYTACEL** LEFT



**MRYAERO** 10mm (PAIR)  
**MRYAERO8** 8mm (PAIR)

Motocp  
Exhausts  
Screens  
Commuter  
Controls  
Headlights  
Indicators  
MIRORS  
Rear Lights  
Lifts & Stands  
Tools  
Batteries & Chargers  
Electrics  
Chain  
Servicing  
Tyres & Tubes  
Security  
Bike Accs  
Luggage  
Rider Accs  
Tank Pads  
Extras

**Yamaha cont...**

			
10mm	10mm	10mm	8mm
<b>MRUCRU</b> <b>MRYCRU</b>	<b>RIGHT</b> <b>LEFT</b>	<b>MRYGPLNG</b> <b>LONG PAIR</b>	<b>MRY002R</b> <b>MRY002L</b>
			<b>RIGHT</b> <b>LEFT</b>
			<b>MRY64531</b> <b>LEFT or RIGHT</b>
			
	<b>CARBON FIBRE EFFECT</b>		
10mm	10mm	10mm	
<b>MRYCC10</b> <b>10mm Yam Thread</b>	<b>MRYF3HBCBN (PAIR)</b>	<b>MRYF3HBLK (PAIR)</b>	<b>MRY005R</b> <b>MRY005L</b>
			<b>RIGHT</b> <b>LEFT</b>
			
			10mm
<b>MRY006R</b> <b>MRY006L</b>	<b>MRY007R</b> <b>MRY007L</b>	<b>MRY008R</b> <b>MRY008L</b>	<b>MRY009</b>
<b>RIGHT</b> <b>LEFT</b>	<b>RIGHT</b> <b>LEFT</b>	<b>RIGHT</b> <b>LEFT</b>	<b>PAIR</b>
			
		Long Stem	8mm (right reverse thread)
<b>MRY010R</b> <b>MRY010L</b>	<b>MRY011R</b> <b>MRY011L</b>	<b>MRY012R</b> <b>MRY012L</b>	<b>MRY014R</b> <b>MRY014L</b>
<b>RIGHT</b> <b>LEFT</b>	<b>RIGHT</b> <b>LEFT</b>	<b>RIGHT</b> <b>LEFT</b>	<b>RIGHT</b> <b>LEFT</b>
			
10mm (right reverse thread)			
<b>MRY015R</b> <b>MRY015L</b>	<b>MRY016R</b> <b>MRY016L</b>	<b>MRY017R</b> <b>MRY017L</b>	<b>MRY018R</b> <b>MRY018L</b>
<b>RIGHT</b> <b>LEFT</b>	<b>RIGHT</b> <b>LEFT</b>	<b>RIGHT</b> <b>LEFT</b>	<b>RIGHT</b> <b>LEFT</b>

**MotoGP**  
**Exhausts**  
**Screens**  
**Commuter**  
**Controls**  
**Headlights**  
**Indicators**  
**MIRRORS**  
**Rear Lights**  
**Lifts & Stands**  
**Tools**  
**Batteries & Chargers**  
**Electrics**  
**Chain**  
**Servicing**  
**Tyres & Tubes**  
**Security**  
**Bike Accs**  
**Luggage**  
**Rider Accs**  
**Tank Pads**  
**Extras**  
[www.bikeit.co.uk](http://www.bikeit.co.uk)



**Yamaha cont...**



10mm (right reverse thread)

**MRY019R** RIGHT  
**MRY019L** LEFT



**MRY020R** RIGHT  
**MRY020L** LEFT



10mm (right reverse thread)

**MRY021R** RIGHT  
**MRY021L** LEFT



**MRY022R** RIGHT  
**MRY022L** LEFT



**MRY023R** RIGHT  
**MRY023L** LEFT



**MRY024R** RIGHT  
**MRY024L** LEFT



**MRY025R** RIGHT  
**MRY025L** LEFT

Please use this space to jot any notes about Bike It products and New Releases.

We are constantly adding information to our website [www.bikeit.co.uk](http://www.bikeit.co.uk) including new product releases, application updates etc. All information is available as downloads, please visit to keep up to date.

---

---

---

---

---

---

---

---

---

---

---

---

---

---

---

---

---

---

---

---

---

---

---

---

- Motorcycle
- Exhausts
- Screens
- Commuter
- Controls
- Headlights
- Indicators
- Tools
- Batteries & Chargers
- Electrics
- Chain
- Service
- Tyres & Tubes
- Security
- Bike Accs
- Luggage
- Rider Accs
- Tank Pads
- Extras

## Handlebar Mirror Mount

Universal fitting mount fits 25mm bars, includes additional inner sheath to make fitment to 22mm bars. 10mm mirror thread.

Order Code: **MRUMNT01**



Universal fitting mount fits 22mm bars. 10mm mirror thread.

Order Code: **MRUMNT04**



## Mirror Extender

This mount offers 40mm horizontal and 27mm vertical extension. Available with 10mm standard and 10mm Yamaha thread fitment

Order Code	Thread
<b>MRUMNT08</b>	10mm Standard
<b>MRUMNT12</b>	10mm Yamaha



## Mirror Adaptors

Adaptors that allow fitment of different size mirror threads.

Order Code	Description	Colour
<b>MRUADAP810</b>	8mm to 10mm	Alloy
<b>MRUADAP810B</b>	8mm to 10mm	Black
<b>MRUADAP108</b>	10mm to 8mm	Alloy
<b>MRUADAP108B</b>	10mm to 8mm	Black



Left hand Yamaha mirrors have a standard clockwise thread, right hand Yamaha mirrors have a reversed anti-clockwise thread.

The right hand adaptors in these kits will allow a universal 10mm or 8mm standard thread mirror to be attached. It has a 10mm reverse thread at the base, and an internal 10mm or 8mm standard thread at the top.

The left hand adaptor in this kit simply raises the height of the left mirror to match the right hand.



Order Code	Description
<b>MRYADAP1010</b>	Black kit allows 10mm standard thread mirrors to be mounted to Yamaha's -
<b>MRYADAP10CH</b>	Chrome kit allows 10mm standard thread mirrors to be mounted to Yamaha's -
<b>MRYADAP810</b>	Conversion kit allows 8mm standard thread mirrors to be mounted to Yamahas

## Bar Mount Adaptors

Bar mount 10mm adaptors

**BLACK**

Order Code	Mounting Thread	Thread
<b>MRAF1STBLK</b>	Thread	Standard
<b>MRAF1YTBK</b>	Thread	Yamaha

**CARBON LOOK**

<b>MRAF1STCBN</b>	Thread	Standard
<b>MRAF1YTCBN</b>	Thread	Yamaha



## Adjustable Mount Adaptors

10mm inner thread with 10mm or 8mm bolt options.

Order Code	Bolt size
<b>MRUMNT16</b>	10mm
<b>MRUMNT20</b>	8mm



## Handlebar Mount Adaptors

Handlebar mount adaptors for 10mm mirrors. Ideal for F1 mirrors. 22mm bar diameter fitment.

**BLACK**

Order Code	Mounting Thread	Thread
<b>MRAF1SBBLK</b>	Handlebar	Standard
<b>MRAF1YBBLK</b>	Handlebar	Yamaha

**CARBON LOOK**

<b>MRAF1SBCBN</b>	Handlebar	Standard
<b>MRAF1YBCBN</b>	Handlebar	Yamaha



## Blind Spot Mirrors

Convex wide angle mirror eliminates blind spots. Adjustable mirror fits different riding positions. Effectively increases viewing angles. Pair.



Order Code: **MRUBLND**



[www.bikekit.co.uk](http://www.bikekit.co.uk)  
 Motorbikes  
 Exhausts  
 Screens  
 Commuter  
 Controls  
 Headlights  
 Indicators  
 Mirrors  
 Rear Lights  
 Lifts & Stands  
 Tools  
 Batteries & Chargers  
 Electrics  
 Chain  
 Servicing  
 Tyres & Tubes  
 Security  
 Bike Accs  
 Luggage  
 Rider Accs  
 Tank Pads  
 Extras



## LED Rear Lights

Clear Lens version incorporates red LED's in the stop/tail function, and also have unique integral LED indicators in amber colour, enabling stock indicators to be removed for trimmed down look or to be kept as additional safety feature. \*

Cool Grey smoked-lens version incorporates red LED's in the stop/tail function, but do not have integral indicators.

Both formats are easy to install, simply bolting in place of the existing OEM unit and benefitting from OEM block connectors for quick and hassle-free wiring.



MODEL	YEAR	CLEAR LENS & INDS Order Code	COOL GREY LENS Order Code
-------	------	------------------------------	---------------------------

### APRILIA

RSV 1000	98-00	LEDA001	#
RSV 1000	01-03	LEDA003	#
RSV 1000 SP	98-99	LEDA001	#
RSV 1000 Tuono	02-05	LEDA003	#
RSV 4	09-12	LEDA005	LEDA105

### BMW

S 1000 RR	09-12	LEDB002	LEDB102
-----------	-------	---------	---------

### DUCATI

Monster 600	94-07	LEDD023	#
Monster 696	09-12	LEDD046	#
Monster 750	94-07	LEDD023	#
Monster 900	94-07	LEDD023	#
748	94-02	LEDD010	#
749	03-07	LEDD061	#
848	08-12	LEDD099	#
916	94-02	LEDD010	#
996	94-02	LEDD010	#
998	94-02	LEDD010	#
999	03-07	LEDD061	#
1098 R/S	07-12	LEDD099	#
Multistrada		LEDD061	#
1198	09-11	LEDD099	#

### HONDA

Hornet 600	98-02	LEDH026	LEDH126
Hornet 600	03-06	LEDH093	LEDH193
Hornet 600	07-09	LEDH105	#
CBF600		LEDH033	#
CBR600 FV,FW	97-98	LEDH017	#
CBR600 FX-F7	99-07	LEDH007	LEDH107
CBR600 FS-1/2 Sport	01-03	LEDH027	#
CBR600RR	03-06	LEDH062	LEDH162
CBR600RR	07-12	LEDH077	#
VFR800 Fi	98-01	LEDH039	#
CBR900RR P/R/S/T/V	93-97	LEDH011	#
CBR900RR W/X	98-99	LEDH012	#
CBR900RR Y/1	00-01	LEDH013	#
CBR900RR 2/3	02-04	LEDH058	#
CB1000R	08-12	LEDH111	#
CBF1000		LEDH036	#
CBR1000RR 4,5,6,7	04-07	LEDH062	LEDH162
CBR1000RR	08-09	LEDH081	#
CBR1100XX V/W	97-98	LEDH026	LEDH126
CBR1100XX X-4	99-07	LEDH025	#
VTR1000 FIRESTORM	97-05	LEDH044	#
FV-F5			
VTR1000 SP1 / SP2		LEDH075	#
Shadow VLX	00-05	LEDH026	LEDH126

### HYOSUNG

GT125		LEDM010	#
GT250		LEDM010	#
GV650		LEDM010	#

### KAWASAKI

Ninja 250R (EX250)	08-12	LEDK044	#
ER-6N/F	05-08	LEDK025	#
ER-6	09-10	LEDK036	#
ZX6R G1-2	98-99	LEDK014	LEDK114
ZX6R J1-2, 636 A1P	00-02	LEDK014	LEDK114
ZX636/6RR	03-04	LEDK051	LEDK151
ZX6-RR / ZX636	05-06	LEDK080	LEDK180
ZX6R	07-08	LEDK067	#
ZX6R	09-10	LEDK134	LEDK234
ZZR600	05-07	LEDK014	LEDK114
ZR-7 / S	99-04	LEDK014	LEDK114
ZX7R P1-7, RR	96-03	LEDK002	#
Z750S		LEDK080	LEDK180
Z750	>06	LEDK051	LEDK151
Z750	07-12	LEDK087	LEDK187
ZX9R C1-C2	98-99	LEDK014	LEDK114
ZX9R E1-E2 F1P-F2P	00-03	LEDK014	LEDK114
ZX10R	04-05	LEDK070	LEDK170
ZX10R	06-07	LEDK080	LEDK180
ZX10R	08-09	LEDK087	LEDK187
Z1000	03-06	LEDK051	LEDK151
Z1000	07-09	LEDK087	LEDK187
Z1000	10	LEDK101	#
ZRX1100	99-05	LEDK034	LEDK334
ZRX1200	99-05	LEDK034	LEDK334
ZX12R A1-A2	00-01	LEDK029	#

MODEL	YEAR	CLEAR LENS & INDS Order Code	COOL GREY LENS Order Code
-------	------	------------------------------	---------------------------

### KAWASAKI cont...

ZX12R B1H-B4H	02-05	LEDK029	#
ZZR1400	06-11	LEDK098	#

### MV AGUSTA

F4 all models	>09	LEDM001	#
Brutale		LEDM001	#
F4 all models	10>	LEDM003	LEDM103

### SUZUKI

GS500/F	03-06	LEDH026	LEDH126
GSF600 V-X Bandit	96-99	LEDS051	#
Gladius	09>	LEDS071	#
GSF600 Y-6 Bandit	00-06	LEDS037	LEDS137
GSF650 Bandit	05-08	LEDS057	LEDS157
GSF650 Bandit	09-10	LEDS072	#
GSR600	06>	LEDS064	#
GSX600F Katana	98-02	LEDS059	#
GSX600F Katana	03-06	LEDS018	#
GSXR600 W V-X SRAD	97-00	LEDS008	#
GSXR600 Y,K1-K3	00-03	LEDS009	LEDS109
GSXR600 K6-K7	06-07	LEDS047	#
GSXR600	08-09	LEDS069	#
SV650/S X-K2	99-02	LEDS015	#
SV650/S K3-K5	03-07	LEDS075	#
GSX750F Katana	98-02	LEDS059	#
GSX750F Katana	03-06	LEDS018	#
GSXR750 W T-X SRAD	96-99	LEDS008	#
GSXR750 Y-K3	00-03	LEDS009	LEDS109
GSXR750 K4-K5	04-05	LEDS060	#
GSXR750 K6-K7	06-07	LEDS047	#
GSXR750	08-09	LEDS069	#
GSXR1000 K1-K2	01-02	LEDS009	LEDS109
GSXR1000 K3-K4	03-04	LEDS050	#
GSXR1000 K5-K6	05-06	LEDS082	#
GSXR1000 K7-K8	07-08	LEDS017	#
GSXR1000 K9-L2	09-12	LEDS069	#
SV1000/S K4-K5	04-07	LEDS075	#
TL1000S V-Y	97-01	LEDS015	#
TL1000R W-K4	98-04	LEDS015	#
GSF1200 V-Y Bandit	97-00	LEDS051	LEDS151
GSF1200 K1-K6 Bandit	01-06	LEDS037	LEDS137
GSF1250 Bandit	07-09	LEDS057	LEDS157
GSXR1300 Hayabusa	99-07	LEDS018	#
RX-K7			
GSXR1300 Hayabusa	08-12	LEDS099	#
GSX1400	01>	LEDS096	#
B-KING	08>	LEDS066	#

### TRIUMPH

TT600	00-04	LEDT045	#
Speed Four	02-05	LEDT045	#
Street Triple 675	07>	LEDT097	#
Daytona 675	05-07	LEDT097	#
Tiger	07-08	LEDT088	#
Speed Triple	02-04	LEDT045	#
Speed Triple	05-07	LEDT088	#
Sprint	05-07	LEDT088	#
595 / 955 Daytona	00-01	LEDT006	#
Daytona	02-04	LEDT045	#

### YAMAHA

FZ6 Fazer	03-07	LEDY077	LEDY177
FZ6R (USA)	09>	LEDY091	#
FZS600 Fazer	98-04	LEDY078	LEDY178
XJ6 / ABS	09-12	LEDY091	#
XJ6 Diversion / ABS	09-12	LEDY091	#
YZF600 Thundercat	96-04	LEDY021	#
YZF-R6	98-00	LEDY022	#
YZF-R6	01-02	LEDY072	#
YZF-R6	03-05	LEDY055	#
YZF-R6	06-07	LEDY002	LEDY102
YZF-R6	08-12	LEDY046	LEDY146
FZ1 Fazer	06-09	LEDY036	#
FZS1000 Fazer	01-05	LEDY016	#
MT-01	05-09	LEDY089	#
YZF1000 Thunderace	96-04	LEDY067	#
YZF-R1	98-99	LEDY019	#
YZF-R1	00-01	LEDY016	#
YZF-R1	02-03	LEDY056	#
YZF-R1	04-06	LEDY071	#
YZF-R1	07-08	LEDY097	LEDY197
YZF-R1	09-12	LEDY090	#
XVS1100	99-06	LEDY021	#
V-Max	09-12	LEDY092	#

\*It is the users responsibility to ensure compliance to their country's regulations.

**LED Rear Lights cont...**



Smoked Lens

**LED rear light units available in: CLEAR LENS with indicators & SMOKED LENS without indicators**



Clear Lens



LEDA001



LEDA003



LEDA005 / LEDA105  
(Smoked Lens image)



LEDB002 / LEDB102



LEDD010



LEDD023



LEDD046



LEDD061



LEDD099



LEDH007 / LEDH107



LEDH011



LEDH012



LEDH013



LEDH017



LEDH025



LEDH026 / LEDH126



LEDH027



LEDH033



LEDH036



LEDH039



LEDH044



LEDH058



LEDH062 / LEDH162



LEDH075



LEDH077



LEDH081



LEDH093 / LEDH193



LEDH105



LEDH111



LEDK002



LEDK014 / LEDK114



LEDK025

Motocp  
Exhausts  
Screens  
Commuter  
Controls  
Headlights  
Indicators  
Mirrors  
Rear Lights  
Lifts & Stands  
Tools  
Batteries & Chargers  
Electrics  
Chain  
Servicing  
Tyres & Tubes  
Security  
Bike Accs  
Luggage  
Rider Accs  
Tank Pads  
Extras  
[www.bikeit.co.uk](http://www.bikeit.co.uk)





Smoked Lens

**LED rear light units available in:  
CLEAR LENS with indicators  
& SMOKED LENS without indicators**



Clear Lens



LEDK029



LEDK034 / LEDK234



LEDK036



LEDK044



LEDK051 / LEDK151



LEDK067



LEDK070 / LEDK170



LEDK080 / LEDK180



LEDK087 / LEDK187  
(Smoked Lens image)



LEDK098



LEDK101



LEDK134 / LEDK234



LEDM001



LEDM003 / LEDM103



LEDM010



LEDS008



LEDS009 / LEDS109



LEDS015



LEDS017



LEDS018



LEDS037 / LEDS137



LEDS047



LEDS050



LEDS051 / LEDS151



LEDS057 / LEDS157



LEDS059



LEDS060



LEDS064



LEDS066



LEDS069



LEDS071



LEDS072

**Motorcycle**  
**Exhausts**  
**Screens**  
**Commuter**  
**Controls**  
**Headlights**  
**Indicators**  
**Mirrors**  
**Rear Lights**  
**Lifts & Stands**  
**Tools**  
**Batteries & Chargers**  
**Electrics**  
**Chain**  
**Servicing**  
**Tyres & Tubes**  
**Security**  
**Bike Accs**  
**Luggage**  
**Rider Accs**  
**Tank Pads**  
**Extras**

**LED Rear Lights cont...**



Smoked Lens

**LED rear light units available in:  
CLEAR LENS with indicators  
& SMOKED LENS without indicators**



Clear Lens



LEDES075



LEDES082



LEDES096



LEDES099



LEDT006



LEDT045

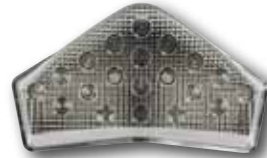

LEDT088



LEDT097



LEDY002 / LEDY102



LEDY016



LEDY019



LEDY021



LEDY022



LEDY036



LEDY046 / LEDY146



LEDY055



LEDY056



LEDY067



LEDY071



LEDY072



LEDY077 / LEDY177



LEDY078 / LEDY178



LEDY089



LEDY090



LEDY091



LEDY092



LEDY097 / LEDY197

[MotorGP](#)  
[Exhausts](#)  
[Screens](#)  
[Commuter](#)  
[Controls](#)  
[Headlights](#)  
[Indicators](#)  
[Mirrors](#)  
[Rear Lights](#)  
[Lifts & Stands](#)  
[Tools](#)  
[Batteries & Chargers](#)  
[Electrics](#)  
[Chain](#)  
[Servicing](#)  
[Tyres & Tubes](#)  
[Security](#)  
[Bike Accs](#)  
[Luggage](#)  
[Rider Accs](#)  
[Tank Pads](#)  
[Extras](#)  
[www.bikeit.co.uk](http://www.bikeit.co.uk)



## Vortex LED Rear Light

LED stop/tail light unit (55mm diameter). Aggressive contour styling with feature inner cut-out. Cool grey tinted lens. Simple screw back fitting for easy installation. Sold individually. E-Marked.

**NEW**

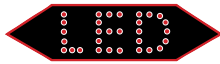

Order Code: **RLTLED19**



## Flare LED Rear Light

"Flare" LED rear/brake light. 55mm diameter lens. Simple screw back fitting

Order Code: **RLTLED03**

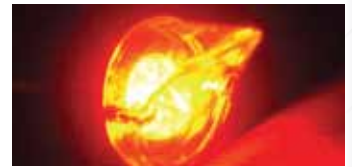
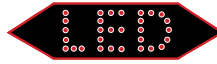

## Flare 2 LED Stop / Tail Light with Integral Indicator

An LED stop/tail light set in a similar body as the Flare LED rear light.

This new version also includes a single integral indicator LED bulb (as only one indicator is inbuilt, two units are required to enable left and right indicators).

Sold individually.

Two bolt (4mm diameter) fitment on rear.

Order Code: **RLTLED15**

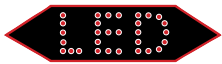

REPLACEMENT BULBS  
Order Code Description  
**LEDBLB03** Red/Stop Tail  
**LEDBLB04** Amber Indicator



## Mini Wedge LED Rear Light

A micro-sized LED stop/tail light with number plate light.

Size: 69mm (W) x 24mm (H) c 28mm (D)

E-marked

Two bolt (3mm diameter) fitment on rear

Order Code: **RLTLED16**

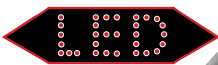

## Invader LED Rear Light

"Invader" LED rear/brake light in chrome oval housing, with number plate bracket and light

Order Code: **RLTLED05**

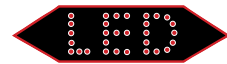

Motocp  
Exhausts  
Screens  
Commuter  
Controls  
Headlights  
Indicators  
Mirrors  
Rear Lights  
Lifts & Stands  
Tools  
Batteries & Chargers  
Electrics  
Chain  
Servicing  
Tyres & Tubes  
Security  
Bike Accs  
Luggage  
Rider Accs  
Tank Pads  
Extras

### Black Eye LED Rear Light

Steel bodied mini rear light unit (59mm diameter)  
Black bodied with dark smoked lens  
Integral red LED stop/tail light  
Fully adjustable mounting plate with 5mm bolt fittings  
E-marked

Order Code: **RLTLED17**

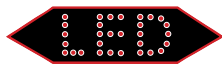

### Blaze LED Rear Light

- Stylish replacement stop/tail light
- Integral number plate light
- LED's perform quicker and are brighter than conventional bulb type rear lights
- Universal 12v fitting
- Perfect for Sportsbikes, Streetfighters and Custom bikes
- Use individually or two for twin effect
- 90mm x 50mm

Order Code    Description  
**RLTLED09**    Black  
**RLTLED10**    Chrome



### Twin Maltese Cross LED Rear Light

"Twin Maltese Cross" LED rear/brake lights in chrome housing (10.5x5x3cm), with number plate light feature

Order Code: **RLTLED06**

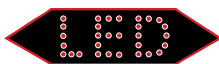

### 3D Lens Maltese Cross LED Rear Light

"3D lens Maltese Cross" LED rear/brake light features a unique 3D effect lens with Maltese Cross detail, set in an oval chrome housing.

Size: 13cm x 6.5cm x 5.5cm

Complete with number plate light.

Order Code: **RLTLED07**



### Maltese Cross LED Rear Light

LED stop/tail light.  
Maltese cross clear lens.  
E-marked.

Order Code:  
**RLTLED14**

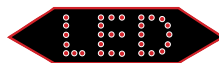



## Cobra Head LED Rear Light

"Cobra Head" LED rear/brake light in high chrome housing, with number plate bracket and light

Order Code: **RLTLED04**



## Mini Tombstone LED Rear Light

Mini Tombstone LED rear/brake light, with number plate bracket and light. E-marked.

Order Code: **RLTLED12**



## Strike LED Stop/Tail Light

Universal LED stop/tail light with integral number plate light. Clear lensed with internal feature contoured chromed reflector base. Fitment by two 6mm bolts. Fully E-marked. 135mm (W) x 45mm (H) x 58mm (D)

Order Code: **RLTLED08**



## Tribe LED Rear Light

Tribe is a universal 2 bolt fixing tail and brake light unit. Available in Black or Chrome base options, (base depth 20mm). Tribe features powerful Red LED's which perform quicker and are brighter than standard bulbs. This fully E-marked product also features a unique honeycomb effect clear lens (lens depth 20mm).

Order Code Colour

**RLTLED01** Black base clear lens

**RLTLED02** Chrome base clear lens



## Tri-Lite LED Rear Light

This unique 12V LED stop/tail light unit incorporates LED's instead of standard twin filament bulbs. A bed of bright LED's illuminate to act as a brake and tail light, reaction time being noticeably quicker and are brighter compared to standard twin filament bulbs. Fully E-marked.

Order Code Colour

**RLTTRIC** Clear lens

**RLTTRIR** Red lens



Motorc  
 Exhausts  
 Screens  
 Commuter  
 Controls  
 Headlights  
 Indicators  
 Mirrors  
 Rear  
 Lights  
 Lifts &  
 Stands  
 Tools  
 Batteries &  
 Chargers  
 Electrics  
 Chain  
 Servicing  
 Tyres &  
 Tubes  
 Security  
 Bike  
 Accs  
 Luggage  
 Rider  
 Accs  
 Tank  
 Pads  
 Extras

**Universal Rear Lights**

**NEW**



**Classic British**  
Order Code: *RLTBLB02*



**Original twin round**  
Order Code: *RLTRND*



**Chrome twin surround**  
Order Code: *RLTTCHE*



**Original twin square**  
Order Code: *RLTTSQU*



**Tombstone Rear/ brake light, with number plate illumination**  
Order Code: *RLTTO*

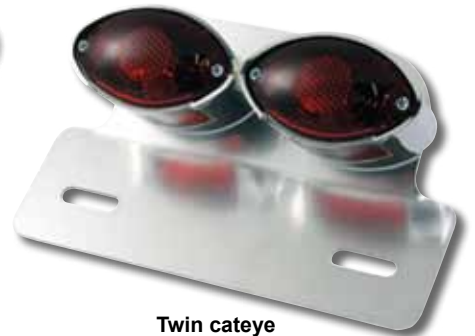

**Twin cateye**  
Order Code: *RLTCATT*



**Ness Rear/ brake light, with number plate illumination**  
Order Code: *RLTNESS*



**Street Rear/ brake light, with number plate illumination**  
Order Code: *RLTSTR*



**Single cateye**  
Order Code: *RLTCATS*



**Complete Lucas type**  
Order Code: *RLTLUCC*



**Lucas type**  
Order Code: *RLTLUC*



**Custom chrome**  
Order Code: *RLTCH*



**NEW**

**Replacement rubber base gasket for RLTLUCC**  
Order Code: *RLTLUC*

Motocp  
Exhausts  
Screens  
Commuter  
Controls  
Headlights  
Indicators  
Mirrors  
**Rear Lights**  
Lifts & Stands  
Tools  
Batteries & Chargers  
Electrics  
Chain  
Servicing  
Tyres & Tubes  
Security  
Bike Accs  
Luggage  
Rider Accs  
Tank Pads  
Extras  
[www.bikeit.co.uk](http://www.bikeit.co.uk)



## Universal Rear Lights



**Enduro**  
Order Code: **RLTEND**



**3D Skull rear/brake light, with number plate illumination**  
Order Code: **RLTSKU**



**Nightlight**  
Order Code: **RLTNL**

## LED Rear Light Bulbs

LED upgrade replacements for standard rear light bulbs. Tail and brake light function  
Super bright LEDs in red and white LED colour options. 12V BAY15D base fitment  
Available in two LED configurations - flat and panoramic  
Flat configuration features rear-facing LEDs set into a level bed  
Panoramic configuration features rear-facing and side-facing LEDs offering increased arc of light emission

NB – does not act as a number plate light

Order Code	Description
<b>LEDBLB01</b>	Flat, red LEDs
<b>LEDBLB02</b>	Flat, white LEDs
<b>LEDBLB05</b>	Panoramic, white LEDs
<b>LEDBLB06</b>	Panoramic, red LEDs

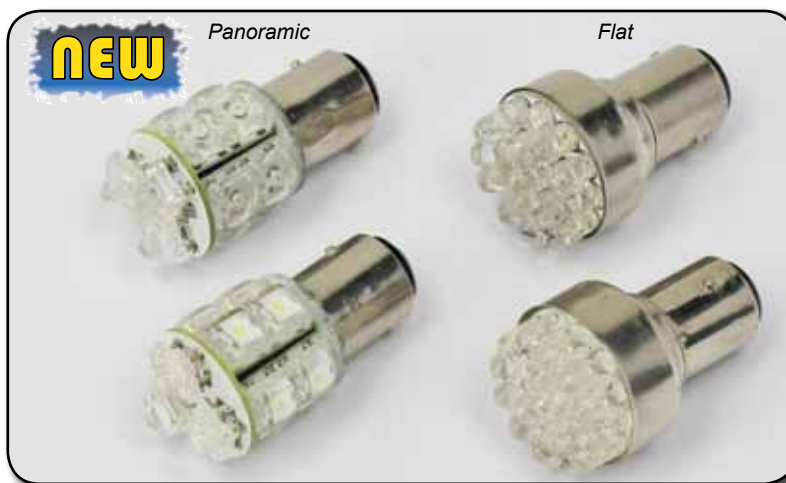

## Rear Light Bulbs

Order Code	Description	Qty	Base	Volt	Watt	Bulb	Colour
<b>BLB02</b>	12v 21/ 5w	10 pieces	BAY15D	12	21/5	G18.5	Clear
<b>BLB26</b>	12v 21/ 5w	1 piece	T20/7443	12	21/5	G	Red
<b>BLB27</b>	12v 23/ 8w	1 piece	BAY15D	12	23/8	S25	Red
<b>BLB30</b>	12v 21/ 5w	1 piece	BAY15D	12	21/5	S25	Clear
<b>BLB39</b>	Pack of 5 BLB27						
<b>BLB40</b>	Pack of 5 BLB30						



Motocp  
Exhausts  
Screens  
Commuter  
Controls  
Headlights  
Indicators  
Mirrors  
**Rear Lights**  
Lifts & Stands  
Tools  
Batteries & Chargers  
Electrics  
Chain  
Servicing  
Tyres & Tubes  
Security  
Bike Accs  
Luggage  
Rider Accs  
Tank Pads  
Extras

## Number Plate Hanger Brackets

Lightweight aluminium bracket for mounting number plate, number plate light and rear indicators.

Features multiple-locating base plate for universal fitment, hinged bracket allows optimum angle adjustment of number plate. Indicator mounts are adjustable through 4 widths or removable. A totally versatile bracket allowing fitment of all road-legal and show-only plate sizes. Designed to be used with Solar (RLTNUM03) and Cluster (RLTNUM05 / 07) number plate lights.

Order Code: **RLTNPT10**



Universal adjustable number plate hanger bracket with indicator mounts.

Order Code: **RLTNPT05**



## LED Spoiler Rear Light

Durable plastic universal spoiler, with three bolt fitting locations  
 Features 10mm indicator fitting mounts on side  
 Incorporates integral LED stop/tail light  
 Clear lens with red LEDs  
 (12V 0.2W)  
 E-marked

Order Code: **RLTLED18**



## Rear Fender LED Rear Light Spoiler

Universal spoiler fits to rear fenders  
 Incorporates integral LED stop/tail light  
 (12v 0.2W)  
 E-marked.

Order Code: **RLTLED11**



## Faze Number Plate Light

Premium metal bodied LED number plate light

Order Code: **RLTNUM19**



## LED Number Plate Lights Bolts

Machined alloy 6mm number plate bolts  
 13mm diameter dome housing incorporates single white LED  
 for number plate light illumination  
 Supplied as pair

Order Code:  
**RLTNUM17**





## LED Blade Indicator with Stop/Tail Light

3-in-1 LED unit with indicator, tail light and brake light function. Aggressive body styling with two feature cut-outs. Super-bright LEDs. 75mm width. Supplied as pair. E-Marked.

Front matching indicators available see page 114.

Order Code: **RLTLED20**



**NEW**

## LED Number Plate Light

Plastic bodied number plate light with 3 super-bright LEDs. Single bolt/nut fitment. Size: 60x20x45mm (WxHxD). E-Marked.

Order Code: **RLTNUM20**



**NEW**

## LED Number Plate Light

Micro LED number plate light, with universal fitting bracket and fixings. Perfect for tail conversions. Size: 37mm x 19mm x 9mm E-marked.

Order Code: **RLTNUM01**



## Solar LED Number Plate Light

'Solar' LED number plate light, universal screw fitting. 12v 0.2w four bright LED's. Size: 56mm x 25mm E-marked.

Order Code: **RLTNUM03**



NB, this product is NOT solar-powered. It should be connected to the motorcycle's electrical circuit as per original number plate light unit

## Atom LED Number Plate Light

These tiny units feature a "brow" on the lens to direct the emitted white light downwards onto the number plate. Can be fitted above the number plate or used as number plate bolts. Universal 6mm bolt fitting. 12V 1.4W E-marked. Size: 2.6 x 1.8 x 1.7cm

Order Code	Colour
<b>RLTNUM09</b>	Black
<b>RLTNUM11</b>	Chrome

Actual size:



## Cluster LED Number Plate Light

'Cluster' LED number plate lights comprise of a high quality aluminium body, incorporating 4 bright white LED's. Universal two bolt fitting. 12v 0.2w E-marked.

Order Code	Colour
<b>RLTNUM05</b>	Black
<b>RLTNUM07</b>	Brushed Aluminium

**METAL BODIED**



Motorcycle  
Exhausts  
Screens  
Commuter  
Controls  
Headlights  
Indicators  
Mirrors  
Rear Lights  
Lifts & Stands  
Tools  
Batteries & Chargers  
Electrics  
Chain  
Servicing  
Tyres & Tubes  
Security  
Bike Accs  
Luggage  
Rider Accs  
Tank Pads  
Extras

## Biketek Raiser Stand

Biketek Raiser Stands enable easy lifting and positioning of motorbikes.

Utilising a bike specific adaptor the stand is connected to the motorcycle frame, an inbuilt hand-operated lifting mechanism raises the bike and both wheels clear of the ground.

The chassis of the stand is mounted on swivel casters, allowing the bike to be effortlessly rolled into any position in a workshop or garage.

Max load 230kg  
Raised height 15cm

**NEW**



Shown with Ducati adaptor



Model	Year	Order Code
<b>BMW</b>		
S1000RR	10-12	PDSRSR01
<b>DUCATI</b>		
848	ALL	PDSRSR03
999	ALL	PDSRSR03
1098	ALL	PDSRSR03
1198	ALL	PDSRSR03
<b>HONDA</b>		
CBR600RR	07-11	PDSRSR09
CBR1000RR	08-12	PDSRSR11
<b>KAWASAKI</b>		
ZX10R	08-10	PDSRSR12
<b>MV</b>		
BRUTALE	ALL	PDSRSR08
F4	ALL	PDSRSR08
<b>SUZUKI</b>		
GSXR600	06-10	PDSRSR13
GSXR750	06-10	PDSRSR13
GSXR1000	09-10	PDSRSR02
<b>YAMAHA</b>		
R6	06-11	PDSRSR07
R1	04-06	PDSRSR10
R1	07-08	PDSRSR04
R1	09-10	PDSRSR05
R1	11-12	PDSRSR06

## 360° Rear Floating Stand

This device works in the same way as a rear paddock stand to raise the rear wheel of motorbikes. The stand incorporates a floating dolly set on 360° swivel castors, allowing the bike to be moved easily and accurately sideways and diagonally.

Order Code: PDSR024

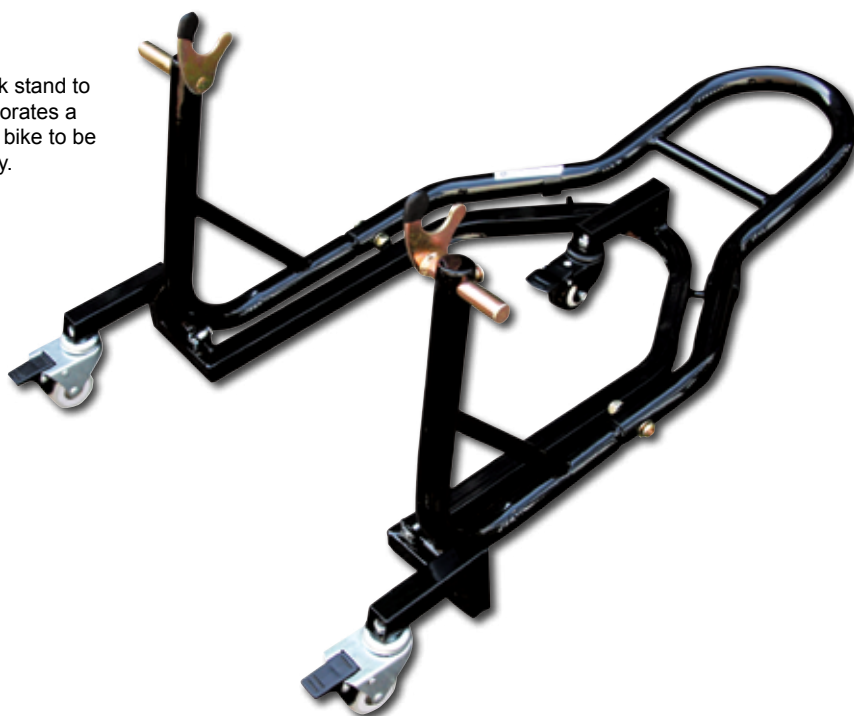

Motocp  
Exhausts  
Screens  
Commuter  
Controls  
Headlights  
Indicators  
Mirrors  
Rear Lights  
Lift & Stands  
Tools  
Batteries & Chargers  
Electrics  
Chain  
Servicing  
Tyres & Tubes  
Security  
Bike Accs  
Luggage  
Rider Accs  
Tank Pads  
Extras



## Paddock Stands

Bike Tek Front and Rear Paddock Stands allow easy and safe lifting of wheels for most repair and maintenance jobs. Extra heavy duty construction, these stands are available in red finish, supplied with front under-fork or rear swing- arm cup adaptors. A bobbin hook kit is available for rear stands see page xxx.

### Features:

- Spring loaded quick release under fork and cup adaptors
- HD oil resistant wheels
- Protective rubber base bungs

Order Code	Description
<b>PDSFRT</b>	Red front paddock stand
<b>PDSTAND</b>	Red rear paddock stand

### MULTIPACKS

<b>PDSTANDB</b>	Rear Paddock Stand dealer pack - 6 pcs
<b>PDSTANDC</b>	Front Paddock Stand dealer pack - 6 pcs

<b>PDS2PC</b>	Front and Rear Stand Set
---------------	--------------------------



Front paddock stands MUST be used in conjunction with a rear paddock stand.

# BIKETEK

## SERIES 3

PDSFRT



PDSTAND



Series 3 paddock stands utilise a unique design to create a sturdier and stronger stand, the revised handle shape offers better handling for lifting motorcycles.

Wheel design may vary

## Static Rear Stand

This new rear stand from Bike Tek offers a unique method of motorcycle storage, especially suited for dealership displays and long term private home storage.

A 9mm steel support bar is inserted through the rear wheel axle, which is then secured to the stand body. The bike is pushed backwards and raises into position on the stand. Cleaning and maintenance work can be carried out when the bike is mounted on the stand (except for tasks that involve removal of the rear wheel).

Front paddock stands can still be used in conjunction with the Bike Tek static stand.

Manufactured from 1.4mm steel, 23mm diameter tubing, the stand is a 1pc unit requiring no assembly and offering optimum strength and rigidity.

Finished in durable powder-coating and with protective ground-contact bungs.

Order Code: **PDSR014**

# BIKETEK



- Motorcycle
- Exhausts
- Screens
- Commuter
- Controls
- Headlights
- Indicators
- Mirrors
- Rear Lights
- Tools & Stands
- Tools
- Batteries & Chargers
- Electrics
- Chain
- Servicing
- Tyres & Tubes
- Security
- Bike Accs
- Luggage
- Rider Accs
- Tank Pads
- Extras

## Aluminium Box Paddock Stands

Aluminium box section tubing paddock stands. Lightweight and extremely rigid. Self-assembly construction, each side-section connected by 3 bolts. Features PU blue wheels. 30 x 30mm box section base.

Order Code	Description
<b>PDSR016</b>	Rear stand, with bobbin adaptors
<b>PDSR018</b>	Front stand, with rubber under-fork rockers



NB: Bike must be fitted with swinging arm bobbins (not included) when using PDSR016

## Aluminium Jumbo Box Stands

Oversize aluminium box sections make these stands extremely durable and rigid. Self-assembly construction, 3-bolts securing each side section to the handle-base. Oversize 45 x 45mm box section base.

Order Code	Description
<b>PDSR020</b>	Rear stand with bobbin fit hardware
<b>PDSR022</b>	Front stand with self-adjusting under-fork hardware



NB: Bike must be fitted with swing-arm bobbins (not included) when using PDSR020

## Aluminium Paddock Stands

The Bike Tek Aluminium Race Paddock Stands are manufactured from ultra lightweight aluminium over-sized tubing offering a robust and sturdy build quality. Rear stands are supplied with bobbin fork mounts which are width adjustable to fit all twin swing-arm motorcycles, the mounts are lockable by means of integral allen head bolts. Suitable for all motorcycles fitted with swinging arm bobbins / cotton reels.

Front stands are 1 piece construction, which can be width adjusted. Interchangeable pins allow for use on bikes with split level forks. These are serious upgrades from standard steel paddock stands! The locking bobbin fork mounts and light weight make it especially suited for track and paddock use where speed and ease of use is essential.

Order Code	Description
<b>PDSR001</b>	Rear
<b>PDSR008</b>	Front

Wheel design may vary





## Front Head Stand

The Bike Tek front head stand folds out to enable a motorcycle to be lifted by the front steering head tube. This offers maximum access to the front end for all repair, cleaning and maintenance work. Each stand is supplied with a kit of 5 of the most popular sized head lift pins covering 90% of motorcycles (including 13mm, 15mm, 16.5mm, 17mm and 18mm). Other larger size pins are available separately. Pins are easily and quickly changeable, making the stand extremely versatile across a wide range of bikes.

Order Code Description  
**PDSHEAD01** Front head stand with 5 pins

### REPLACEMENT LIFT PINS

(Available separately)

**PDSHEADP13** 13mm head lift pin  
**PDSHEADP15** 15mm head lift pin  
**PDSHEADP165** 16.5mm head lift pin  
**PDSHEADP17** 17mm head lift pin  
**PDSHEADP18** 18mm head lift pin

### OVERSIZED LIFT PINS

(Available separately)

**PDSHEADP19** 19mm head lift pin  
**PDSHEADP20** 20mm head lift pin  
**PDSHEADP21** 21mm head lift pin  
**PDSHEADP24** 24mm head lift pin  
**PDSHEADP27** 27mm head lift pin

Front head stands must be used in conjunction with a rear paddock stand.

# BIKETEK

HEADSTAND PINS

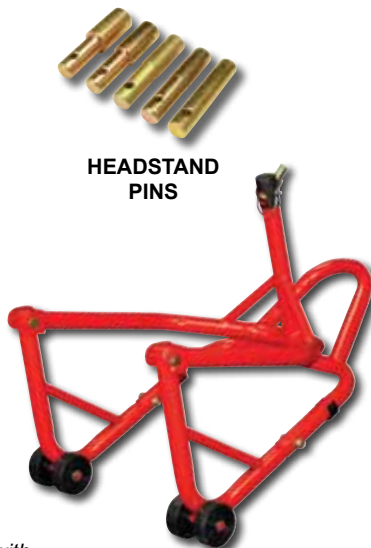

UNIQUE FOLD AWAY DESIGN

Wheel design may vary



## Side Paddock Stand for Single Swing Arms

Side paddock stands utilise an adaptor pin which inserts into the rear axle allowing lifting of bike for maintenance.

Order Code Fits  
**PDSH285** Honda CB1000R 09>  
**PDSVFR** Honda VFR  
**PDSNC** Honda NC30/RC30  
**PDSUDC** Ducati 848, 916, 998, 996, 748, Super Motard, Monster S4R/S2R, Multistrada 1000, Hypermotard, 1100SS  
**PDS40** Ducati 1098 07>, 1198, Streetfighter  
**PDS42** MV Agusta F4/Brutale, early Ducati 1098 >07  
**PDSTRI** Triumph, Daytona T595>99, Daytona 955i >01  
**PDST01** Triumph - All models including SPRINT

### REPLACEMENT AXLE PINS

Order Code Pin Diameter  
**PDSPINC** 21.5mm  
**PDSPINE** 27mm  
**PDSPINA** 28.5mm  
**PDSPINB** 31mm  
**PDSPING** 40mm  
**PDSPINF** 42mm

Side paddock stands are suitable for general maintenance and repair work. They are not intended for storage use.

# BIKETEK



Pin type may vary.

Wheel design may vary

## Paddock Stand Wheel Upgrade Kit

Premium rubberised wheel set on a robust ABS yellow inner. Each pack contains 4pcs of wheel.

Order Code: **PDSR012**



Motocp  
 Exhausts  
 Screens  
 Commuter  
 Controls  
 Headlights  
 Indicators  
 Mirrors  
 Rear Lights  
 Lifts & Stands  
 Tools  
 Batteries & Chargers  
 Electrics  
 Chain  
 Servicing  
 Tyres & Tubes  
 Security  
 Bike Accs  
 Luggage  
 Rider Accs  
 Tank Pads  
 Extras

## Swing Arm Spools

Premium CNC machined swing arm spools. Bolt onto motorbike swing arms enabling bike to be lifted by a paddock stand with hook or fork adaptors. Available in three bolt sizes to fit most motorcycles.

6mm fit most Yamaha and Aprilia.  
8mm fit most Honda, Suzuki and Ducati.  
10mm fit most Kawasaki.

Order Code	Size	Colour
SWG06BK	6mm	Black
SWG06BU	6mm	Blue
SWG06GD	6mm	Gold
SWG06SL	6mm	Silver
SWG08BK	8mm	Black
SWG08BU	8mm	Blue
SWG08GD	8mm	Gold
SWG08SL	8mm	Silver
SWG10BK	10mm	Black
SWG10BU	10mm	Blue
SWG10GD	10mm	Gold
SWG10SL	10mm	Silver

**NEW**



## Bobbin Spools

CNC machined swing arm spools. Bolt onto motorbike swing arms enabling bike to be lifted by a paddock stand with hook or fork adaptors. Available in three bolt sizes to fit most motorcycles.

6mm fit most Yamaha and Aprilia  
8mm fit most Honda, Suzuki and Ducati  
10mm fit most Kawasaki

Order Code	Size	Colour
PDSBOB10	10mm	Alloy
PDSBOB10BK	10mm	Black
PDSBOB10BU	10mm	Blue
PDSBOB10GD	10mm	Gold
PDSBOB10R	10mm	Red
PDSBOB6	6mm	Alloy
PDSBOB6BK	6mm	Black
PDSBOB6BU	6mm	Blue
PDSBOB6GD	6mm	Gold
PDSBOB6R	6mm	Red
PDSBOB8	8mm	Alloy
PDSBOB8BK	8mm	Black
PDSBOB8BU	8mm	Blue
PDSBOB8GD	8mm	Gold
PDSBOB8R	8mm	Red



For Swingarm spools see page 251

## Kawasaki Bobbin Bolts (pair)

Order Code	Description
PDSBOBK10	10mm thread, 1.25 pitch, offset
PDSBOBK12	12mm thread, 1.25 pitch, offset
PDSBOBKZX	10mm thread, 1.25 pitch, long

Bobbin spools specific to Kawasaki bikes with offset bobbin.



For Swingarm spools see page 251

## Swing Arm Spool Sliders

Dual function swing arm spools

- Protect swing arm in crash
- Allow bike to be lifted by paddock stand

Manufactured from high grade Synthetic Polymer (STP) or T6 Aluminium, these Spool Sliders allow high impact strength with anti-friction and non-shatter properties. Each kit is CAD designed, CNC machined, and uses the highest grade steel bolts and aluminium inserts as required.

Use of Swing Arm Spool Sliders is intended to limit damage to a motorcycle in a fall or accident. It is NOT a guarantee of no damage.

Fits	Thread	Order Code	Order Code
		Black STP	Aluminium
Honda/Suzuki/Ducati	8mm 1.25	7010309	8010300
Yamaha/Aprilia	6mm 1.00	7010609	8010600
Kawasaki	10mm 1.50	7010709	8010700
Kawasaki	10mm 1.25	7010709K	8010700K



Application list is not exhaustive, see specification above for both sizes.

## Bobbin Hook Adaptors

Pair of bobbin hook adaptors replace standard cup adaptors, allowing you to lift the bike by the bobbins instead of swing arms.

Order Code: PDSHOOK



Motocp  
Exhausts  
Screens  
Commuter  
Controls  
Headlights  
Indicators  
Mirrors  
Rear Lights  
Lift & Stands  
Tools  
Batteries & Chargers  
Electrics  
Chain  
Servicing  
Tyres & Tubes  
Security  
Bike Accs  
Luggage  
Rider Accs  
Tank Pads  
Extras  
www.bikeit.co.uk



## Bike Tek Adjustable Wheel Chock

- 1pc construction wheel chock provides excellent stability of motorcycles in storage or transit.
- 38mm tubular steel construction.
- Steel base-plate for front wheel location features 2 side-plates to grip front wheel.
- Side-plates are lockable and width adjustable up to 8" maximum, to ensure secure fit.
- Can be used free-standing, but can also be permanently fixed to ground or inside vehicle via 2 fixing locations (fittings not supplied).

For use in several locations an optional quick-release plate is available, enabling the wheel chock to be removed quickly and easily - ideal if the chock is used inside a vehicle.

The quick-release plate can be bolted to any fixed surface via the 4 fixing location (fittings not supplied), the wheel-chock simply connected by 1 bolt-fitting.

Order Code	Description
<b>PDSCHK23</b>	Adjustable Wheel Chock
<b>PDSCHK25</b>	Quick-release base plate

NB Intended for use on front wheel of motorcycles only



## Wheel Brace

This steel tubing wheel brace bolts into the ground providing a base for motorcycle wheels to be located.

Can be fixed in vehicles and on trailers for increased stability in transit, equally suitable bolted on the floor for parking aid and a security lock point.

160mm width.

Fittings not supplied.

NB: bike must also be secured by tie-down straps, or with the bike's centre/side stand

Order Code: **PDSCHK21**

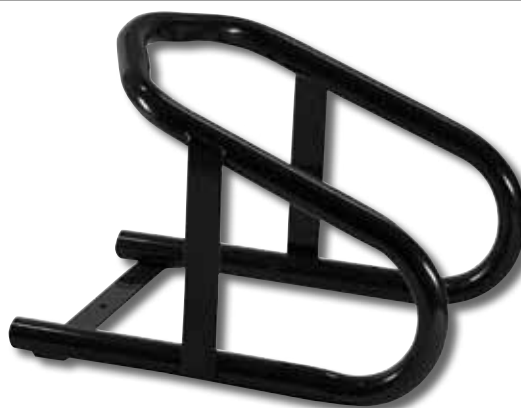

## Self-assembly Wheel Chock

### Self-assembly Wheel Chock

Supports front wheel of bike during storage and transit.

Fully adjustable to fit wheels 12" to 18" (adaptor kit available to convert to 21").

Features pivot clamp which locks the front wheel securely by the bike's weight.

Can be bolted to ground.

Order Code: **PDSCHK17**

### 21" Wheel Adaptor Kit

Replacement support strut converts the self-assembly wheel chock to fit wheels up to 21".

Order Code: **PDSCHK19**



Note: Bike must also be secured using tie-down straps

## Wheel Chock

One piece construction tubular wheel chock.

Supports front wheel of bike during storage and transit.

Fully adjustable to fit wheels 12" to 18".

Features pivot clamp which locks the front wheel securely by the bike's weight.

Can be bolted to ground.

Order Code: **PDSCHK15**



## Aluminium Loading Ramps

**NEW**

Strong and durable loading ramps, made from lightweight aluminium, enable safe and easy loading and unloading of motorcycles and scooters. Space-saving folding design, allows compact storage when not in use. Features coated extension arms on top end for stability during use. Rigid aluminium box section side rails. Strong aluminium centre plates with cut-outs for tyre grip. Available in three width options. Max load 340kgs/ramp.



PDSRAMP07



PDSRAMP08



Order Code	Type	Width	Length
<b>PDSRAMP06</b>	Bi-folding	200mm	2150mm
<b>PDSRAMP07</b>	Tri-folding	230mm	1935mm
<b>PDSRAMP08</b>	Tri-folding	280mm	1935mm

PDSRAMP06



## Loading Ramp

Constructed from ultra lightweight aluminium, and utilising a unique folding design, Loading Ramps are perfect for loading motorcycles on / off trailers and transport vehicles.

Each ramp is 2170mm length when extended, available in two widths. Max load: 340 Kgs / 750 Lbs

Order Code	Size
<b>PDSRAMP01</b>	230mm width
<b>PDSRAMP04</b>	280mm width



PDSRAMP01



PDSRAMP04



## Loading Ramp Bag

Padded storage bag for loading ramp. Zip closing with carry handles.

Order Code	Description
<b>PDSRAMP03</b>	Fits PDSRAMP01
<b>PDSRAMP05</b>	Fits PDSRAMP04



NB. Ramp not included

## ATV Loading Ramp

Constructed from ultra lightweight aluminium, and utilising a unique folding design, this Loading Ramp is perfect for loading ATV's and quads, when using two ramps, on / off trailers. Simply order 2 ramps and one adaptor kit. Each kit contains 2 adjustable arms that clip onto the inner struts of each ramp, stabilising and keeping them parallel. Each arm can be adjusted to change the width between ramps from 520mm to 940mm.

EXTENDED PLATE LENGTH = 2170mm  
Max load: 340 Kgs / 750 Lbs per ramp

Order Code	Description
<b>PDSRAMP02</b>	ATV adaptor kit
<b>PDSRAMP01*</b>	Loading ramp, 230mm width
<b>PDSRAMP04*</b>	Loading ramp, 280mm width

\* Order 2 loading ramps for ATV / quad use

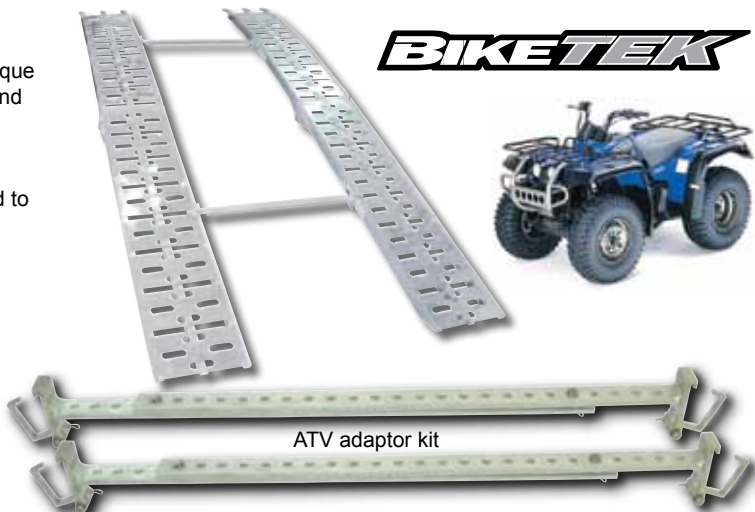

**BIKETEK**

ATV adaptor kit



## Platform Lift Jack

**NEW**

This platform lift jack is designed for raising motorcycles with either a flat base or a tubular frame. A hand-operated scissor-lift mechanism raises the top-platform from a height of 100mm to 340mm. Features two width and height adjustable support struts, with rubber protector inlays, to locate under tubular framed bikes - these support struts are removable when lifting flat based bikes. Base section has two mounting plates, enabling the lift jack to be bolted permanently to table lifts and work stations. Platform size 450mm x 150mm. Max load 500kgs.

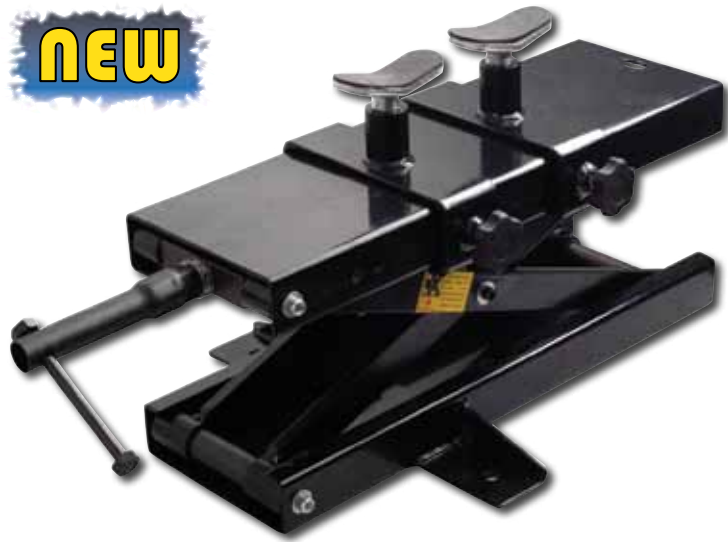

Order Code: **PDSLIFT09**

## Premium Lift Jack

This mini lift jack is suitable for lifting bikes with a flat base or tubular frame, lifting from 100mm to 340mm.

The height and width adjustable cup supports can be added for additional clearance of sumps.

- Max lift 500kgs
- Handle operated (also supplied with socket head adaptor)
- Height and width adjustable removeable cups
- CE approved
- Suitable for ground or table use



**BIKETEK**



Order Code: **PDSLIFT05**

Lift Jack Size: 465mm x 150mm (excluding handle and supports)

**Not to be confused with lower spec alternatives available elsewhere!**

## Americana 2 Hydraulic Workshop Lift

- Unique heavy weight hydraulic lift, designed specifically to lift lower sitting framed bikes, perfect for Harley Davidsons.
- Ideal for cleaning, servicing and adding accessories.
- Manually operated by foot, a hydraulic ram lifting up to 600kgs from height of 121mm (4 3/4") up to 404mm (15 3/4") with hand release valve lowering system.
- Added security of side-locking safety bars.
- Wheel-mounted for on-stand bike manoeuvring, complete with pull-handle
- Manoeuvring pull handle
- Lowest clearance 13cm

Order Code: **PDSAMER02**



**EXCLUSIVELY  
DESIGNED FOR  
HARLEYS!**

**AMERICANA  
HYDRAULIC LIFT 2**

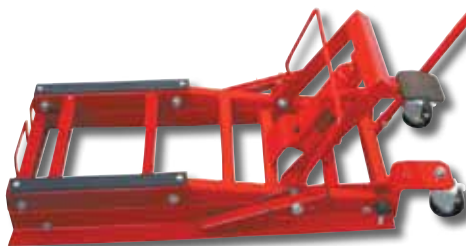

\* An additional supporting block (not supplied) may be required for bikes that have a sump hanging lower than the frame rails or those that have odd height, lower frame rails.

## Americana Hydraulic Workshop Lift

- Unique heavy weight hydraulic lift, suitable to hoist unfaired motorcycles including choppers and cruisers, MX bikes and ATV's
- Perfect for cleaning, servicing and adding accessories.
- Manually operated by foot, a hydraulic ram lifting up to 600kgs from height of 146mm (5 3/4") up to 419mm (16 1/2") with hand release valve lowering system.
- Added security of side-locking safety bars.
- Wheel-mounted for on-stand bike manoeuvring, complete with pull-handle
- Manoeuvring pull handle
- Lowest clearance 15.5cm

Order Code: **PDSAMER01**

**AMERICANA  
HYDRAULIC LIFT**

**UNIVERSAL  
CUSTOM  
DESIGN**



Motorcyc  
Exhausts  
Screens  
Commuter  
Controls  
Headlights  
Indicators  
Mirrors  
Rear  
Lights  
Lifts &  
Stands  
Tools  
Batteries &  
Chargers  
Electrics  
Chain  
Servicing  
Tyres &  
Tubes  
Security  
Bike  
Accs  
Luggage  
Rider  
Accs  
Tank  
Pads  
Extras

## Bike Tek Deluxe Centre Stand Mover

- Deluxe centre stand mover, with 43x18cm plate area for centre stand to locate on.
- Anti-slip covering on plate area.
- 500kgs max load (intended for motorcycles only!).
- Oversize 7cm diameter PU-coated wheels, with 360 degree rotation, for stability and ease of movement.
- Brake mechanism on each individual wheel.
- 25mm clearance from ground to underside of plate.
- Manufactured from 7mm thickness hardened steel sheet.
- Black powder coat finish.



Order Code: **PDSCTR11**



## Motorcycle Mover

This product allows a bike to be easily moved and positioned in confined spaces. Load the motorcycle onto the strengthened plate, and rest the sidestand on the featured side plate. The mover can be pushed effortlessly into the required location.

Order Code: **PDSMVR11**

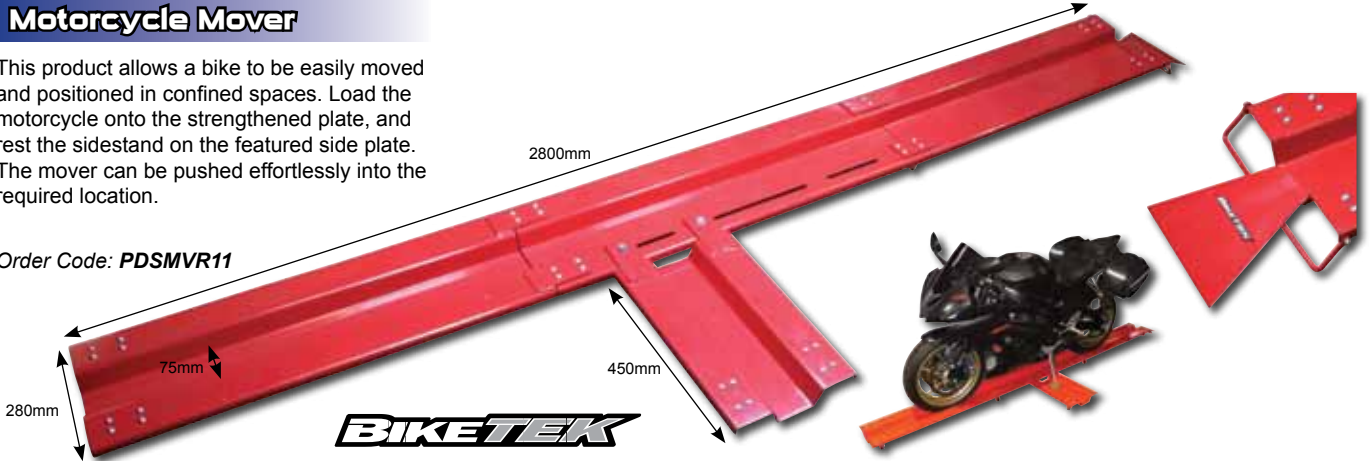

## Wheel Spinner

This device allows front and rear wheels to be rotated for cleaning, tyre inflation and chain lubricating. The rollers utilise sealed bearings, distance between rollers can be adjusted for all sizes of tyre. Galvanised finish. Includes kick-stand puc to raise height of bike for stability in use.

Order Code: **PDSSPN01**



## Centre Stand Mover

Use this stand to manoeuvre motorcycles with centre-stands where space is restricted. Centre stand locates on the plate, 360° casters allow bike to be moved in any direction. Complete with brake mechanism. Ideal for workshop, display room and home garage use. Max load: 150kg

Order Code: **PDSCTR07**





## Hydraulic Motorcycle Workshop Lift Table

Designed to enable efficient and safe access of motorcycles, allowing repairs and servicing, adding accessories and extensive cleaning. Suitable for both workshops and home garages. The table smoothly and safely lifts the motorcycle to an optimum height and position, maximising workshop and garage space. Suitable for all types of motorcycles and scooters, front wheel locks into clamp, bike held stable by centre stand or paddock stand (not supplied).

### FEATURES:

- Table size – 2100 X 620mm
- Side and forward locking wheel clamp
- Foot operated hydraulic ram lifts 400kgs from height of 200mm up to 800mm
- Wheel mounted for ease of manoeuvring, with adjustable locking feet
- Locking side safety bars
- Removeable plate for rear wheel access
- Integrated tie-down hook attachment points
- Automatic height-positioning ramp
- Non-slip metal tread plate
- Max load 400kgs

CE Approved

Order Code: **PDSLIFT03**



**This item is subject to an additional freight charge.**

**BIKETEK**



## Custom Bike Raiser Stand

Adjustable height stand for flatbase or twin tubular frames. Simply locate the contact bar under the bike frame and lever backwards to raise the position.

Min height: 205mm  
Max height: 255mm  
Max weight: 150kg

Order Code	Colour
<b>PDSCUS08</b>	Silver
<b>PDSCUS11</b>	Red

**BIKETEK**

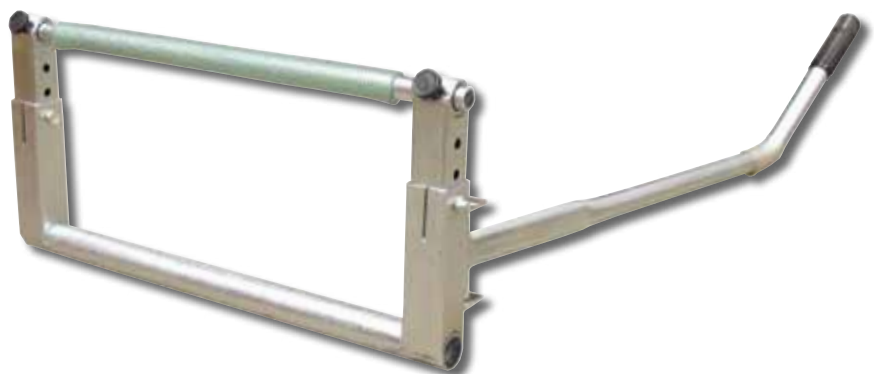

Motocp  
Exhausts  
Screens  
Commuter  
Controls  
Headlights  
Indicators  
Mirrors  
Rear Lights  
Lifts & Stands  
Tools  
Batteries & Chargers  
Electrics  
Chain  
Servicing  
Tyres & Tubes  
Security  
Bike Accs  
Luggage  
Rider Accs  
Tank Pads  
Extras

**NEW**

## Optisan Spill Kits

Optisan spill kits immediately absorb liquid spills including oils, turning the spillage into a powder which can be promptly and efficiently swept away. The kits consist of anti-slip absorbent powder, 10 times more absorbent than clay-based products, which soak up liquids and contains them in a more manageable mass. Suitable for use on all liquids, including oil, fuel, drinks, grease, paints and more.

Available in two formats. 2.5litre multi-use tub, ideal for workshops and garages where frequent spillages are expected. 500ml single-use emergency kit, is supplied in a carton which acts as a dustpan/scrapper, including spill powder, gloves and waste sack - ideal for keeping in vehicles.

Order Code	Description
CLE046	500ml Emergency Spill Kit
CLE048	2.5litre Tub



## Chain Cleaner

- Biodegradable
- Breaks down grime, oil and grease
- Suitable for all chain types including O and X-ring
- 500ml

Order Code: **CLE020**



## Chain Lube

- Synthetic clear, dry non stick lubricant
- PTFE based, withstands all weathers
- Performs in high temperature and wear conditions
- 500ml

Order Code: **CLE022**



## Silicone Care Spray

- Silicone based fast acting dressing and lubricant
- Protects, lubricates and renovates plastic, rubber, metal and other surfaces
- Leaves treated area with a sheen finish
- 500ml

Order Code: **CLE028**



## Brake Disc Cleaner

- Quickly breaks down oil, dirt and grime
- Quick drying formula
- Useable on clutch plates and housings
- Useable as a contact cleaner
- 500ml

Order Code: **CLE026**



## Degreaser

- Biodegradable
- Foaming formulation for increased dwell time
- Breaks down grime, oil and grease
- 500ml

Order Code: **CLE024**



## MW40 Penetrating Spray

- Multi-purpose lubricant and penetrating fluid
- Frees and lubricates seized mechanisms and components
- Displaces water, protects electrics
- Quickly penetrates through oxides and soiling
- Leaves a lubricating protective film on treated areas
- 500ml

Order Code: **CLE030**



Motocp  
Exhausts  
Screens  
Commuter  
Controls  
Headlights  
Indicators  
Mirrors  
Rear Lights  
Lifts & Stands  
Tools  
Batteries & Chargers  
Electrics  
Chain  
Servicing  
Tyres & Tubes  
Security  
Bike Accs  
Luggage  
Rider Accs  
Tank Pads  
Extras  
www.bikeit.co.uk



## Mechanic Glove - Open Finger

Lightweight and comfortable mechanic glove, featuring three open-ended fingers for increased sensitivity when handling smaller components.  
 Extended cuff with velcro closure.  
 Reinforced palms.  
 Flatlock stitching on open fingers.  
 Offers hand protection during workshop tasks.

**NEW**

Order Code	Size
GLVMEC10S	Small
GLVMEC10M	Medium
GLVMEC10L	Large
GLVMEC10XL	XL



## Mechanic Glove - Full Finger

Lightweight and comfortable mechanic glove.  
 Extended cuff with velcro closure.  
 Reinforced palms.  
 Offers hand protection during workshop tasks.

**NEW**

Order Code	Size
GLVMEC12S	Small
GLVMEC12M	Medium
GLVMEC12L	Large
GLVMEC12XL	XL



## Latex Gloves

Dermatologically friendly  
 Prevents Infection

Order Code	Description
GLVLM	Medium latex gloves (Box of 100)
GLVLT	Large latex gloves (Box of 100)
GLVLTXL	XL latex gloves (Box of 100)



## Sure Grip Mechanic Gloves

'Sure Grip' Mechanics Glove with rubber palm and finger grips. Offers protection to hand and increases grip. Great for handling tyres  
 1 Size Fits All

Order Code:  
**GLVMEC02**



## Polishing Ball

Polishing ball, soft textile construction. Fits to any hand drill and allows easy access for deep reach cleaning. Washable.

Order Code: **POLBALL01**



Colour may vary

## Polishing & Buffing Kit

For use with electric polishers and hand drills. Kit features a selection of foam and woolen pads to polish metal and plastic surfaces using cream and paste polishes. The pads are interchangeable and fully washable (reusable more than 80 washes).

Kit includes:

- Hand-drill adaptor
- Foam/Velcro mop-pad
- Woolen fleece wash pad
- Fine foam polish pad (black)
- Light foam polish pad (blue)

Order Code: **POLKIT01**



## Professional Aluminium & Stainless Steel Polishing Kit

This kit includes all that is needed to polish stainless steel and aluminium to a fantastic high shine finish, using a hand-drill or polisher. 3 grades of polishing compounds and mops take the surface through each stage from scratch removal to finishing.

Kits includes:

- Hand-drill adaptor
- 1 x stitched 5" hard mop
- 1 x stitched 5" medium mop
- 1 x 5" soft polishing mop
- 3 x extra large polishing compounds

Order Code: **POLKIT03**



### REPLACEMENT MOP PACK

- Includes:
- 1 x stitched 5" hard mop
  - 1 x stitched 5" medium mop
  - 1 x 5" soft polishing mop
- Order Code: **POLKIT05**

Motocp  
 Exhausts  
 Screens  
 Commuter  
 Controls  
 Headlights  
 Indicators  
 Mirrors  
 Rear Lights  
 Lifts & Stands  
**TOOLS**  
 Batteries & Chargers  
 Electrics  
 Chain  
 Servicing  
 Tyres & Tubes  
 Security  
 Bike Accs  
 Luggage  
 Rider Accs  
 Tank Pads  
 Extras

**PRO-CLEAN** has been the market leader of motorcycle cleaning and maintenance products in the UK and Europe for over fifteen years. We are continuously challenged to develop the best complete range of products by the many top-flight teams who use the range, but still keep an affordable price tag.

The exciting news is that **PRO-CLEAN** is now DEVELOPED FOR YOUR SPORT. This has been achieved by working closely with some of the biggest names in each discipline. Which ever your ride of choice, there is now a range of products for you.

All you need to do is go out and get dirty!



## Pro Clean

DEVELOPED FOR YOUR SPORT

Pro-Clean is a unique blend of fully biodegradable chemicals designed to clean every part of the exterior of your race machine.

The intelligent chemical formulation releases the correct level of active cleaning agents to ensure perfect results every time from mud covered rally cars to the most refined precious metals and carbon fiber components of delicate racing cycles.

Order Code	Description
<b>PCNPCL1</b>	1 Litre
<b>PCNPCL5</b>	5 Litre
<b>PCNPCL25</b>	25 Litre



## Pro Care

DE WATERING, ANTI RUST TREATMENT

Pro-Care is a blend of lubricants and low evaporation penetrating oils designed to displace water from the hidden places where rust and corrosion may occur between washes and after poor weather.

Order Code	Description
<b>PCNPCR1</b>	1 Litre
<b>PCNPCR5</b>	5 Litre
<b>PCNPCR25</b>	25 Litre



## Pro Tecton

WATER BASED CORROSION INHIBITOR

Pro Tecton is completely unique & revolutionary water based corrosion inhibitor, which leaves a microfilm coating designed to protect against road salt, rust and general corrosion attacks from the elements.

Pro Tecton can be sprayed safely over any surface. Once dry it leaves a molecular film, which protects the treated surface. Pro Tecton does not affect brake discs or other brake components.

Order Code	Description
<b>PCNPTN1</b>	1 Litre
<b>PCNPTN5</b>	5 Litre



## De Greaser

HIGH POWER DE GREASING AGENT

Degreaser is a specially designed and blended formulation, perfectly balanced to remove grease and dried oil build up on chains, sprockets, spindles, engines etc. Heavily soiled components can be immersed in the De Greaser fluid and left until corrosion and soiling is removed from the surface.

Order Code	Description
<b>PCNDGR1</b>	1 Litre
<b>PCNDGR5</b>	5 Litre



## Grip Lock

NON-ADHESIVE GRIP FITTING SPRAY

Grip Lock is a trick new product from the Pro-Clean lab. It's unique non adhesive formula is specifically designed to take the effort out of fitting new grips to motorcycles, quads and mountain bikes.

Using Grip Lock couldn't be easier. Simply hold the can approximately 50mm from the neck of the grip and apply one short burst, slide the grip onto bars and adjust into position. The grip is locked in just a few minutes making the task of changing grips not only clean, but easy.

Grip Lock leaves no sticky residue on the bar and when the grip is eventually replaced, a new one can be fitted in seconds.

Order Code	Description
<b>PCNGLA070</b>	70 ml



## Super Polish

SILICONE FREE NON ABRASIVE POLISH

Super Polish is a rich non abrasive silicone free polish designed to work on all surfaces including plastic, paintwork and aluminium leaving a superb gloss finish. Simply apply to a small area at a time with a dry lint free cloth and buff to brilliant shine. Avoid contact with grip surfaces of seat covers as polish is difficult to remove from grained surfaces.

Order Code	Description
<b>PCNSP500</b>	500ml

Colour may vary



## Mega Spray

EXTENDING TRIGGER SPRAY

Mega Spray is an extending trigger for the 5 Ltr containers allowing the user to simply carry and spray.

Order Code:
<b>PCNMGS</b>



Motocp  
Exhausts  
Screens  
Commuter  
Controls  
Headlights  
Indicators  
Mirrors  
Rear Lights  
Lifts & Stands  
Tools  
Batteries & Chargers  
Electrics  
Chain  
Servicing  
Tyres & Tubes  
Security  
Bike Accs  
Luggage  
Rider Accs  
Tank Pads  
Extras  
www.bikeit.co.uk



## Tyre Paste

Universal tyre paste for quick and easy mounting and demounting of tyres. Non-staining, protects beads and rims.

**NEW**

Order Code Description  
**PCNTP5** 5kg



## Tyre Lube

NON RESIDUE, LOW FRICTION TYRE FITTING GEL

Tyre Lube...Tyre fitting with ease!

This revolutionary tyre fitting gel takes all the effort out of fitting a tyre. Tyre Lube leaves no unsightly paste stains and the tyre slips on quickly and easily. The unique quick drying, non-corrosive formulation is perfectly safe on all types of tyres and rims.

Order Code Description  
**PCNTL250** 250ml  
**PCNTL25WS** 2.5 Litre



## Hand Scrub

ADVANCED FORMULA HAND CLEANER

Hand Scrub is a superior hand cleaning gel containing polymer beads, sanitizer and moisturizers to ensure clean and protected hands.

Order Code Description  
**PCNHS500** 500ml



Colour may vary

## Anti-Fling Chain Lube

HIGH POWER CHAIN LUBE

**NEW**

This high performance chain lube is a scientifically designed for all Open chains as well as O and X ring plus the latest Z ring chains.

The formulation of the lubricant allows for the penetration of the inner roller area and prevents throw-off at high speed. Clear polymer chain lube protects against corrosion, reduces power loss and is proven to prolong chain and sprocket life.



Order Code Description  
**PCNCLA400B** Aerosol, 400ml

## Chain Lube (Aerosol)

CLEAR POLYMER CHAIN LUBE

This high performance chain lube is a scientifically developed lubricant designed for all open chains.

The formulation of the lubricant allows for the penetration of the inner roller area and prevents throw-off at high speed. Clear polymer chain lube protects against corrosion, reduces power loss and is proven to prolong chain and sprocket life.



Order Code Description  
**PCNCLA400** Aerosol, 400ml

## Super Lube (Aerosol)

DE WATERING, ANTI RUST SPRAY

This superior grade maintenance spray is a heavy duty multi purpose spray designed to displace and repel moisture from moving parts and electrical apparatus, helps protect against rust and corrosion, lubricates and releases seized metal components.

Super Lube leaves a light protective lubricant film on surfaces ensuring prolonged anti moisture protection.



Order Code Description  
**PCNSLA400** Aerosol, 400ml

## De Greaser (Aerosol)

HIGH POWER CLEANER DE GREASER

Aerosol De Greaser is a fast acting quick drying cleaner/degreaser specially designed for the fast and easy removal of grease and oil deposits on discs, chains, sprockets, engines etc, when the need to remove grease is immediate. Aerosol degreaser is completely safe on discs and all braking components, leaves no residue and dries instantly.



Order Code Description  
**PCNDGA400** Aerosol, 400ml

## Pro Clean Race Pack

RACE ESSENTIALS FROM PRO CLEAN

Replacing the "Buc - Kit", the Pro Clean Race Pack is bigger and better than ever before, but keeps its affordable price tag. Perfect for those who are new to the Pro Clean range, or a great gift to anyone who already uses the products. The kit contains: 1 LTR PRO CLEAN • 400ml SUPER LUBE • 400ml CHAIN LUBE • 400ml DE GREASER • 250ml TYRE LUBE • 500ml HAND SCRUB • BIG HANDFUL SPONGE • DETAIL BRUSH • CHAMOIS

Order Code: **PCNRP1**



Motocp  
Exhausts  
Screens  
Commuter  
Controls  
Headlights  
Indicators  
Mirrors  
Rear Lights  
Lifts & Stands  
Tools  
Batteries & Chargers  
Electrics  
Chain  
Servicing  
Tyres & Tubes  
Security  
Bike Accs  
Luggage  
Rider Accs  
Tank Pads  
Extras

### 2in1 Microfibre Chenille Wash Mit

Microfibre tufted surface for general washing. Microfibre mesh sponge surface for bug and spot removal. Machine washable.

Order Code: **CLE042**

**NEW**

TOP



BOTTOM



### 2in1 Microfibre Cleaning Mit

Green microfibre surface for washing and polishing. Blue cellular sponge surface for bug and spot removal. Machine washable

Order Code: **CLE004**

TOP



BOTTOM



### 3pc Workshop Brush Kit

Set of three workshop brushes for effective cleaning and maintenance of motorcycle engine and frame parts. Includes one nylon bristle and two metal bristles brushes.

Order Code: **CLE050**

**NEW**



### Parts Cleaning Brush

Soft bristle brush head set on a wooden handle, suitable for cleaning more delicate engine and frame parts.

Order Code: **CLE044**

**NEW**



### Bristle & Foam Brush

Double action brush featuring rough foam and nylon bristle sections. Suitable for both general and wheel cleaning. Contoured easy-grip handle.

Order Code: **CLE034**



### Claw Bristle Brush

Nylon bristle brush featuring open-end enabling all-round cleaning of wheels, forks, swinging arms etc. Contoured easy-grip handle.

Order Code: **CLE036**



### Wheel Brush

Tapered nylon bristle brush suitable for both general and wheel cleaning. Contoured easy-grip handle.

Order Code: **CLE038**



### Detail Brush

Double bristled nylon brush suitable for both general and wheel cleaning. Contoured easy-grip handle.

Order Code: **CLE002**



### Polishing Wax Pads

Microfibre pads for application and removal of finishing wax. Machine washable. 3 piece pack

Order Code: **CLE008**



### Trigger Spray

Replacement cleaner trigger spray, 28mm neck fitment.

Order Code: **CLE032**



Motocp  
Exhausts  
Screens  
Commuter  
Controls  
Headlights  
Indicators  
Mirrors  
Rear Lights  
Lifts & Stands  
Tools  
Batteries & Chargers  
Electrics  
Chain  
Servicing  
Tyres & Tubes  
Security  
Bike Accs  
Luggage  
Rider Accs  
Tank Pads  
Extras  
www.bikeit.co.uk



## Mains-Water Power Washer

A mains-water fed power washer which runs independently of mains-electricity. Ensures safe and efficient washing of motorcycles and vehicles. Simply attaches to standard fitment garden-hose (not supplied)

- 1900 P.S.I / 130 Bar
- Interchangeable nozzles for spray options
- 8 Litre/min flow rate
- Efficient 4 stroke generator
- Robust wash lance
- 8m high-pressure wash hose
- Steel tube frame with tube-type tyres

Order Code:  
**WSH003**



**NO MAINS  
ELECTRICITY  
REQUIRED**



## Remote Power Washer

A superbly powerful washer which runs independently of mains electricity and mains water. This unique function enables it to be used remotely at MX events and tracks.

- 2200 P.S.I / 154 Bar
- Interchangeable nozzles for spray options
- 7.5 Litre/min flow rate (2.0 gallons / min)
- Efficient 4 stroke generator
- Robust wash lance
- 8m high-pressure wash hose
- Steel tube frame with tube-type tyres
- Water-feed hose with immersible filter

**Do not confuse this item with other versions commonly available that need mains water and electricity supply.**

Order Code: **WSH004**

**NO MAINS  
ELECTRICITY  
REQUIRED OR  
MAINS WATER**



## Parts Washer

Parts washers are the perfect solution for cleaning parts and components in any workshop or garage, expelling dirt, grease and oil. An integral electrical pump delivers the cleaning fluid along a directional nozzle to soak the part, making light work of brushing and cleaning.

BikeTek washers are available in two sizes, a compact 3.5 gallon work-top unit and a 20 gallon floor-standing unit.

NB. Cleaning solvent NOT included. Instructions detail correct specification solvent to use.

### 3.5 GALLON WASHER

Dimensions: 44cm x 36cm x 26cm  
Removable internal workshelf  
Order Code: **WSH001**



### 20 GALLON WASHER

Dimensions: 76cm x 54cm x 88cm  
Removable internal workshelf  
Order Code: **WSH002**



**BIKETEK**

Motocp  
Exhausts  
Screens  
Commuter  
Controls  
Headlights  
Indicators  
Mirrors  
Rear Lights  
Lifts & Stands  
Tools  
Batteries & Chargers  
Electrics  
Chain  
Servicing  
Tyres & Tubes  
Security  
Bike Accs  
Luggage  
Rider Accs  
Tank Pads  
Extras

www.biketec.co.uk

MotoGP  
 Exhausts  
 Screens  
 Commuter  
 Controls  
 Headlights  
 Indicators  
 Mirrors  
 Rear Lights  
 Lifts & Stands  
**Tools**  
 Batteries & Chargers  
 Electrics  
 Chain  
 Servicing  
 Tyres & Tubes  
 Security  
 Bike Accs  
 Luggage  
 Rider Accs  
 Tank Pads  
 Extras  
 www.bikekit.co.uk

### Brake Bleeding Assistor Kit

Brake bleeding assistor kit utilises a compact unit with one-way valve and connector hoses that simply attach onto the bleed nipple. When the nipple is open and brakes bled, the unit prevents air and old fluid from being pulled back into the system, freeing the user from having to repeatedly open and close the bleed nipple.

Order Code: **BRKKIT01**



### Brake Bleeding Kit

Complete brake bleeding kit includes nipple adaptor, one-way valve, hoses and receiver. Safe and easy bleeding.

Order Code: **BRKKIT03**



### Fluid Receiver

Makes brake bleeding safe and clean. Sturdy canister with vented cap holds bleed fluid delivered from caliper.

Order Code: **BRKKIT05**



### Brake Bleeder/Vacuum Pump

Comprehensive workshop vacuum pump kit. Includes reservoir and nipple adaptor for brake bleeding. The hand operated pump pulls the fluid through the bleed nipple, eliminating need to use the brake lever or pedal. Manual pump with pressure gauge allows testing of many vacuum operated systems, eg fuel pumps, carbs, etc.

Order Code: **BRKKIT07**



### Antifreeze Tester

**NEW**

Anti-freeze level checker enabling accurate coolant levels in winter and summer. For use with Ethylene Glycol, can be used hot or cold.

Order Code: **TLSANT13**



### Manual Fluid Extractor

9.0 litre manual fluid extractor for removal of non-explosive liquids such as engine oil from crankcases, gear oil from transmission cases, coolant and brake fluids. Floor-standing design makes extracting simple and stable. Includes various tubes and fittings for specific fluid removal.

Order Code: **TLSPMP21**



### Fuel Line Clamp

Clamps securely over fuel pipe cutting off fuel flow for engine work.

Order Code: **FLC**





## Fuel Jug

5 litre fuel jug with lid and flex spout.

Order Code	Description
SYP007	Fuel jug
SYP009	Replacement spout.



## Oil Funnel

Metal oil funnel with flex pipe  
Order Code: SYP005



## Auxiliary Fuel Tank

- For use when tuning with fuel tank off bike
- Temporarily replaces fuel tank while synchronizing carbs
- Includes fuel line and in-line petcock
- Graduated fuel tank with hanging hook for gravity feed.

Order Code:  
AUX008

Close up  
of in-line  
petcock



Replacement in-line  
petcock  
Order Code:  
AUX008P

## Fuel Syphon

Hand-pump syphon, simple and efficient  
for transfer of fuels and liquids. Use for  
transferring fuel or for tank draining.  
Order Code: SYP001



## Fuel Funnel

2 pc plastic fuel funnel (funnel & extension  
pipe)

- Removable flexible stem
- Handle
- Gauze filter

Order Code:  
SYP003



## Fuel Jerry Cans

Heavy duty fuel storage cans in 20 litre and 10 litre options. Feature robust carry handle and safety locking cap. Extra safe pouring nozzle available separately.

Order Code	Size
JRC20L	20 litre
JRC10L	10 litre

### POURING NOZZLE

Order Code: JRCPOU



## 10 Litre Oil Pan

10ltr oil drain pan featuring front and rear  
hand-grabs, directional spout, rolled edges to  
prevent spillage.

Order Code: OILPAN10



## 8 Litre Oil Pan

- 8ltr Oil Drain Pan - easy and efficient collection and disposal of engine oil/fluids.
- Non-spill pouring spout.
- Oil filter drain ledge.
- Easy grip rim.

Order Code: OILPAN



## Oil Drain Can

Collected oil is sealed inside can, carry  
handle and stoppers allow can to be removed  
and drained cleanly without spillage.  
6ltr Oil Drain Can  
Easy and efficient collection and disposal  
of oil.

Order Code: OILCAN6



## Fuel Measuring & Mixing

Order Code	Description
GTD001	Graduated measuring cylinder 250ml
GTD002	Graduated measuring bottle with stopper & cap 250ml
GTD003	Graduated measuring jug with handle 500ml
GTD004	Graduated measuring jug with handle 1000ml



GTD003



GTD002



GTD004



GTD001

Motocp  
Exhausts  
Screens  
Commuter  
Controls  
Headlights  
Indicators  
Mirrors  
Rear  
Lights  
Lifts &  
Stands  
Tools  
Batteries &  
Chargers  
Electrics  
Chain  
Servicing  
Tyres &  
Tubes  
Security  
Bike  
Accs  
Luggage  
Rider  
Accs  
Tank  
Pads  
Extras

## Deluxe Tyre Levers

Extended handle-length tyre levers for additional leverage and ease of use.

Order Code Size  
 TYL014 14"  
 TYL017 17"

**NEW**

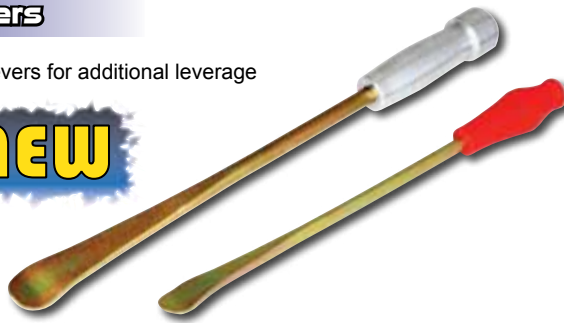

## Tyre Levers

Order Code	Description
TYLR	Round type
TYLF	Flat type
TYLH	Handled deluxe type

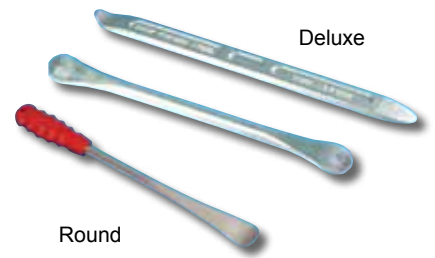

## Spoke Wrench

6-way spoke wrench, 1-6.  
 Order Code: **SPOWRE6**



## Spoke Wrench Set

2 piece spoke wrench set (8,9,10,11)  
 Order Code: **SPOWRE**



## Tyre Paste

Make tyre fitting easy with use of this bead lubricant.  
 Available in 1kg and 5kg tubs.

Order Code Size  
 REP020 1kg  
 REP025 5kg

**NEW**



## Wheel Weight Remover

Hand tool for removing self-adhesive wheel weights and adhesive residue

Order Code: **TLSWG13**



## Tyre Fitting Tool

Eases tyre fitment by positioning tyre, allowing fitter to mount opposite bead.

Order Code:  
**TYLCLP**



## Spark & Spoke Wrench

Multi-function tool with 13mm/16mm spark plug spanner head, with opposite end featuring 3 size spoke key.

Order Code: **SPOWRE9**



## Steel Tyre Valve Puller With Rubber Protector

Valve puller tool with rubber protector for safely pulling long or short valves into rims without damaging the valve or rim.  
 Order Code: **VLVINS**

**NEW**



## Rim Protectors

Rim protector for tyre changing (2 pcs) with connecting cord.  
 Order Code: **RIMPROT**



## Valve Tool

4 Way valve removal tool  
 Order Code: **VLVTOOL**

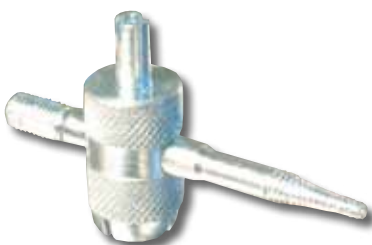

## Air Valve Puller

Simplifies inner tube and tyre fitment, attaches to the valve enabling it to be pulled through the valve hole in wheel rim.

**NEW**

Order Code:  
**VLVPUL**



## Tyre Crush Tool

Long handled tool offers great leverage for tyre removal, forcing tyre beads off the rim.

Order Code: **TYC012**



MotoGP  
 Exhausts  
 Screens  
 Commuter  
 Controls  
 Headlights  
 Indicators  
 Mirrors  
 Rear Lights  
 Lifts & Stands  
**TOOLS**  
 Batteries & Chargers  
 Electrics  
 Chain  
 Servicing  
 Tyres & Tubes  
 Security  
 Bike Accs  
 Luggage  
 Rider Accs  
 Tank Pads  
 Extras  
 www.bikekit.co.uk



## Axle Bolt Punch

Strong bolt punch specific for tapping out axle bolts.

**NEW**

Order Code: **TLSAXL13**



## Professional Front Axle Driver Set

Professional kit of four 1/2" drive spindle keys (17/19/22/24mm) complete with ratchet head and jumbo handle for maximum leverage and ease of use.

Order Code: **TLSAXD08**

### INDIVIDUAL SPINDLE KEYS

**TLSAXD17** 17mm 1/2" drive  
**TLSAXD19** 19mm 1/2" drive  
**TLSAXD22** 22mm 1/2" drive  
**TLSAXD24** 24mm 1/2" drive



## Rear Axle Nut Spanner

Order Code Description

**TLSAXD04** 36mm offset rear axle nut spanner

**TLSAXD10** 32mm straight rear axle nut spanner



## Deluxe Wheel Balancer

Portable wheel balancer  
 Adjustable truing arm  
 Sturdy steel construction  
 Suitable for 10" - 21" wheels  
 Wheel can be mounted on adjustable centering cones or steel rod  
 Max mounting cone diameter 31mm  
 Adjustable side arms up to max 32cm gap

Order Code: **WHB012**



## Digital Tyre Tread Depth Gauge

Suitable to check tyre tread depth, brake shoe and disc pad wear.  
 Large LCD display.  
 Metric/Inch selectable.  
 Manual power on/off.

Order Code: **TGUDIG05**



## Tyre/Bead Breaker

Portable tyre and bead breaker, suitable for all wheel and tyre sizes from 16".  
 Order Code: **TYC008**



## Front Axle Driver Tool

Single tool fits most spindles (17/19/22/24 mm). Use socket or spanner to fit and remove front wheel.

Order Code: **TLSAXD06**



## Wheel Balancer

Portable wheel balancer, includes 17<->25mm cones and spindles needed for precise and easy alignment and balancing. Oversize cones kit 24-38mm available separately.

Order Code Description

**WHB008** Wheel Balancer

**WHB010** 24-38mm Cone Kit



Motocp  
 Exhausts  
 Screens  
 Commuter  
 Controls  
 Headlights  
 Indicators  
 Mirrors  
 Rear Lights  
 Lifts & Stands  
**TOOLS**  
 Batteries & Chargers  
 Electrics  
 Chain  
 Servicing  
 Tyres & Tubes  
 Security  
 Bike Accs  
 Luggage  
 Rider Accs  
 Tank Pads  
 Extras

## Tube & Tyre Repair Glue

200cc canister of repair glue, for adhesion of repair patches to tyres and tubes

Order Code: **REP015**



**NEW**

## Tubeless Tyre Plug Strings

Replacement plug strings for use with tubeless tyre repair tools. Each pack contains 60pcs (6mm x 4")

Order Code: **REP010**

**NEW**



## Tubeless Tyre Repair Kit

Simple kit for temporary repairs of tubeless tyres.

Features rasp tool for preparing the puncture hole, insertion tool and five plug strings.

NB – the repaired tyre should be professionally checked and fixed or replaced at the earliest opportunity

Order Code: **REP005**

**NEW**



## ATV / Quad Puncture Repair Kit

The ATV kit comprises of 50 repair plugs, including tools and adhesives to repair the tyre on site. Complete with robust storage case, the kit should be kept on the vehicle at all times ready for any eventuality.

Order Code: **REM003**



## Motorcycle Puncture Repair Kit

A premium range of puncture repair kits for motorcycles and ATV/Quads. These kits are the same as supplied to the **RAC** and the **AA** roadside service teams.

Motorcycle kits are available for TUBE TYPE and TUBELESS tyres, allowing the rider to make a temporary roadside repair. The kits are compact enough to fit beneath the seat, including all repair materials, air canisters and instructions needed.

### TUBELESS

Repaired tyres must be checked and professionally repaired or replaced within 250 miles, and have speed limitation of max 60kmh.

Suitable for tread area punctures of up to 4mm diameter.

Order Code: **REM001**



## Tubeless Tyre Repair Kit

Contains all tools and adhesives needed for on-road repairs.\*

Order Code: **TTLREP**



### TUBE TYPE

Repaired tyres must be checked and professionally repaired or replaced within 250 miles, and have speed limitation of max 60kmh.

Suitable for tread area punctures of up to 4mm diameter.

Order Code: **REM002**



\* NB. Air canister NOT supplied

Motorcycle  
Exhausts  
Screens  
Commuter  
Controls  
Headlights  
Indicators  
Mirrors  
Rear Lights  
Lifts & Stands  
Tools  
Batteries & Chargers  
Electrics  
Chain  
Servicing  
Tyres & Tubes  
Security  
Bike Accs  
Luggage  
Rider Accs  
Tank Pads  
Extras  
www.bikekit.co.uk



## Digital Tyre Pressure Gauges

Selectable PSI and BAR settings. Pressure range 2-99 PSI, 0.15 - 7.00 BAR.

Order Code Style  
**TGUDIG01** Straight  
**TGUDIG02** Curved



TGUDIG01

Digital readout pressure gauges set in an ergonomic module.

- Rotating Nozzle
- Fully Automatic

Order Code Description  
**TGUDIG03** PSI Type (5 -150 PSI)  
**TGUDIG04** BAR Type (0.5 - 11 BAR)



TGUDIG04

## Jumbo Barrel Foot Pump

Vertical barrelled foot pump with folding foot-stand.

Measures up to 100 PSI / 7.0 BAR.

Over-sized dial for ease of use. Schraeder and Presta valve fitment.

Valve adaptor storage compartment.

Order Code: **PMP007**



Footstand locked in storage position.

## Micro Tyre Pressure Gauge

Undersized tyre pressure gauge ideal for all wheels including spoked.

Measures up to 160 PSI / 11.0 BAR.

PSI / BAR / KPA / Kg-cm2 selectable LCD display.

Order Code: **TGUDIG06**



## Keyfob Pressure Gauge

Tyre pressure gauge keyfob (BAR-PSI reading)

Order Code: **TGUKEY01**



## CO2 Canister Kit

CO2 tyre inflator kit, includes adaptor and two 16gram canisters.

Replacement canisters available separately. Delivers pressure to tyre without manual effort.

Order Code Description  
**PMP005** CO2 canister kit  
**PMP005R** Replacement CO2 canister 16gram



## Mono Cylinder Foot Pump

Mono cylinder footpump. Pressure range 0-100 PSI. TUV approved.

Order Code: **PMP001**



## Pro-Pressure Tyre Monitor

- Easy-read analogue dial
- Displays PSI rating
- Pressure draw-off button for pressure accuracy
- Shock resistant

Order Code: **TGUANA01**



## Low Pressure Gauge

1-20 PSI range gauge. Perfect for off-road and trials.

Order Code: **TGULOW**



## Mini Foot Pump

Mini foot pump with storage pouch and valve adaptors.

Pressure indicator dial in both PSI and BAR scales.

Order Code: **PMP003**



Motor  
 Exhausts  
 Screens  
 Commuter  
 Controls  
 Headlights  
 Indicators  
 Mirrors  
 Rear Lights  
 Lifts & Stands  
**TOOLS**  
 Batteries & Chargers  
 Electrics  
 Chain  
 Servicing  
 Tyres & Tubes  
 Security  
 Bike Accs  
 Luggage  
 Rider Accs  
 Tank Pads  
 Extras

## Oil Filter Pliers

12" drop forged pliers, features toothed jaw for easy oil filter removal. Fits most motorcycle filters, maximum opening 130mm.

Order Code: **OFWPLI**



## Oil Filter Wrench

Oil filter wrenches clamp over fitted oil filter canisters. Enables effortless removal using 3/8" socket handle (not supplied).

Order Code Size

- OFW65** 65mm, 14 flutes, 1 step
- OFW68** 68mm, 14 flutes, 1 step
- OFW76** 74/76mm, 15 flutes, 2 steps
- OFW80** 80mm, 15 flutes, 1 step
- OFW7612** 76mm, 12 flute to fit some BMW



OFW65/68/76/80



OFW7612

## Oil Filter Removal

Two snap-on devices enabling removal of oil filter canisters using 3/8" socket handle (not supplied).

Order Code Description

- OFWSTP** Oil filter wrench strap
- OFWUNI** Universal adjustable oil filter wrench 65-76mm.



OFWUNI



OFWSTP

## Magnetic Spark Plug Sockets

- |                  |                    |
|------------------|--------------------|
| Order Code       | Description        |
| <b>SPKSOC16</b>  | 16mm socket 3/8"   |
| <b>SPKSOC18</b>  | 18mm socket 3/8"   |
| <b>SPKSOC206</b> | 20.6mm socket 3/8" |



## Ignition Spark Plug Tester

Tests for HT spark potential

Order Code: **SPKTEST**



## Deep Reach Plug Wrench

Deep reach plug wrench 15cm reach

Order Code: **WNC10**



## Spark Plug Set

5pc spark plug maintenance set including brush and feeler gauge.

Order Code: **SPKSET**



## Plug Holder

Waterproof canister for spare spark plug (Spark plug not included)

Order Code: **PLUGHOLD**

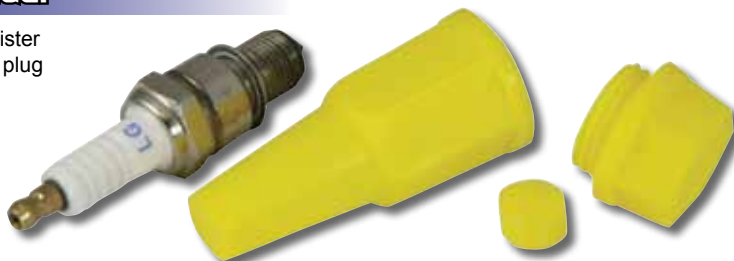

## Oil Filter Removal Screw

Strong handled shaft with screw thread end, for removal of air filter canisters.

**NEW**

Order Code: **OFWSCR**



## 26pc Feeler Gauge Set

Metric and Imperial measurements.

Order Code: **SPKGAU**



## Spark Plug Gauge

Coin type spark plug gauge

Order Code: **SPKCOIN**



MotoGP  
 Exhausts  
 Screens  
 Commuter  
 Controls  
 Headlights  
 Indicators  
 Mirrors  
 Rear Lights  
 Lifts & Stands  
**TOOLS**  
 Batteries & Chargers  
 Electrics  
 Chain  
 Servicing  
 Tyres & Tubes  
 Security  
 Bike Accs  
 Luggage  
 Rider Accs  
 Tank Pads  
 Extras  
 www.bikekit.co.uk



## Magnetic Parts Dish

Strong magnetic parts dish keeps bolts, screws, washers etc\* secure, not on the floor!

Order Code: **TLSMAG01**



\* Contents not included. Colours may vary.

## Foam Kneeling Pad

Durable foam kneeling pads, protects knees from floor whilst working around motorcycles.

Order Code:  
**FOAMPAD01**



## Wall-Mount Tool Holder

This tool holder features 20 plastic hanging-loops allowing screwdrivers, spanners and other tools to be neatly hung on workshop wall.

The holder has 2 drill holes for simple mounting to most vertical surfaces (supplied with 2 mounting screws, but it is the users responsibility to ensure correct fixings are used for surface being attached to).

Order Code: **TLSHLD12**

**NEW**



Tools not included.

## 3pc Magnetic Tool Holder Set

A great addition to any tool shop or garage storage area. Keeps tools off the floor or work bench and within arms reach. Powerful magnets hold tools and other ferrous objects in place.

Sizes: 8", 12", 18"

Order Code: **TLSMAG05**



## Jumbo Creeper Seat

Oversized chromed tubing makes this creeper extra durable and strong. Comfy work for even the biggest lads.

Order Code: **CRP003**



## Pneumatic Creeper Seat

Save your back and knees with this adjustable height creeper seat.

- 360 degree swivel castors
- Tool tray
- Adjustable seat height allows optimum positioning
- 55cm max seat height

Order Code: **CRP002**



## Garage Creeper Seat

This durable Garage Creeper Seat makes working and moving around the garage or workshop comfortable and easy. The Garage Creeper comprises of a heavy-duty steel frame and features an optimum height padded seat in red and 360° swivel castors. Supplied ready for assembly with full, clear instructions.

Order Code: **CRP001**



MOTORCYCLE  
EXHAUSTS  
SCREENS  
COMMUTER  
CONTROLS  
HEADLIGHTS  
INDICATORS  
MIRRORS  
REAR LIGHTS  
LIFTS & STANDS  
TOOLS  
BATTERIES & CHARGERS  
ELECTRICS  
CHAIN  
SERVICING  
TYRES & TUBES  
SECURITY  
BIKE ACCS  
LUGGAGE  
RIDER ACCS  
TANK PADS  
EXTRAS

### Circlip Pliers

Order Code	Description
TLSPLO1	External circlip type
TLSPLO2	Internal circlip type



### Pliers

Order Code	Description
TLSPLO3	6" Diagonal cutting
TLSPLO4	8" Heavy duty
TLSPLO5	6" Longnose

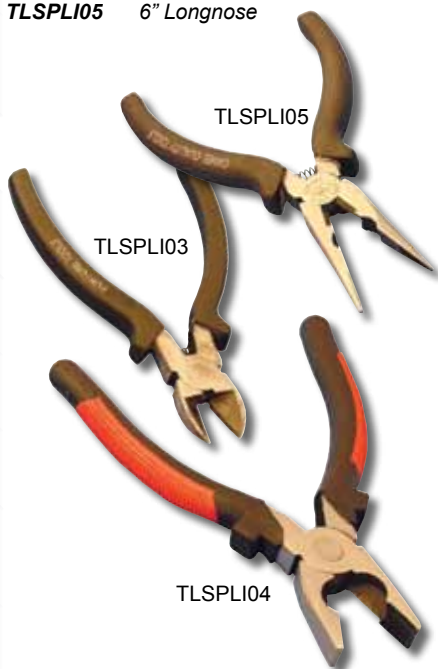

### Emergency Tool Kit

Emergency tool kit, consists of adjustable pliers, spanners (10, 12, 14 and 17mm), allen and cross head screw-driver, plus 12mm and 17mm socket head, complete with carry case. Ideal for under-seat storage

Order Code:  
**TLSEMER**



### Protective Glasses

For garage and workshop use.  
 • Scratch Resistant Polycarbonate Lens  
 • Adjustable length arms  
 • Contoured nose bridge and non-slip fit  
 • Side shield protection  
 • Anti-Fog

CE EN166

Order Code:  
**GLAPRO1**



## BIKETEK

### Torx Keys

Torx key set 8pcs  
 T9/10/15/20/25/27/30/40  
 Order Code: **TORXKEY**



### Allen Keys

10 pc metric Allen key set, 1.5-10mm

Order Code: **ALLKEY**



### Deluxe Allen Keys

9pc extra long ball end hex key set  
 (1.5,2,2.5,3,4,5,6,8 & 10mm)

Order Code: **ALLBALL**



### Vernier Calipers



Stainless steel caliper, 0-150mm range with digital LCD display

Order Code:  
**VGUDIG01**

Stainless steel caliper, 0-150mm measurement

Order Code: **VGU150**



## Deluxe T-Bar Socket Spanners

Superior T-Bars with rubber grip handles, and wrench contact points.

Order Code	Size
TBS08	8 mm
TBS10	10 mm
TBS11	11 mm
TBS12	12 mm
TBS13	13 mm
TBS14	14 mm
TBS17	17 mm
TBS19	19 mm

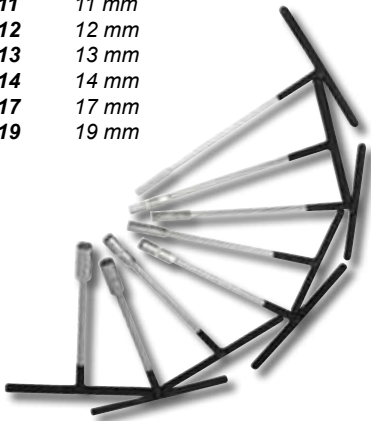

**8pc WORKSHOP PACK**  
Contains one of each size  
Order Code: **TBSSET**

## T-Bar Socket Spanners

Order Code	Size
TSP08	8 mm
TSP10	10 mm
TSP11	11 mm
TSP12	12 mm
TSP13	13 mm
TSP14	14 mm
TSP17	17 mm
TSP19	19 mm



**8pc WORKSHOP PACK**  
Contains one of each size  
Order Code: **TSPSET**

## Y-Bar Sockets

Strong Y-bars with three different sized sockets, for efficient and quick tool selection and use.

**NEW**

Order Code	Sizes
YSP08	8, 10, 12mm
YSP02	9, 11, 13mm
YSP04	12, 14, 17mm
YSP06	14, 17, 19mm



## Deluxe Torx / Star Key Set

Premium quality torx key set, featuring double-ended torx heads on the handle and shaft for varying leverage needs. Durable moulded handle for optimum grip and comfort. Supplied with storage rack. Includes 9pcs torx wrench T10, 15, 20, 25, 27, 30, 40, 45, 50

Order Code:  
**TLSSET14**



## Deluxe Hex Key Set

Premium quality allen / hex key set, featuring double-ended allen heads on the handle and shaft for varying leverage needs. Durable moulded handle for optimum grip and comfort. Supplied with storage rack. Includes 8pcs hex wrench 2, 2.5, 3, 4, 5, 6, 8, 10mm

Order Code: **TLSSET12**

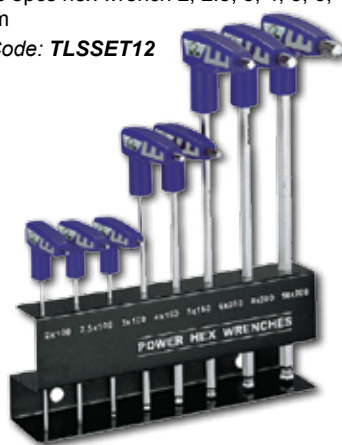

## T-Handle Hexagon Key Set

10pc metric hexagon key set, with storage rack

Order Code: **HEXKEY**



## 5pc Ratchet Spanner Set

5pc ratchet spanner set with reverse action feature.

(8, 9, 10, 11, 12, 13, 14, 17, 19 & 21mm)

Order Code:  
**SPARTC01**



## Ratchet Ring Spanner

4-in-1 Ratchet ring spanner (10, 12, 13 and 14mm)

Order Code: **SPARAT**

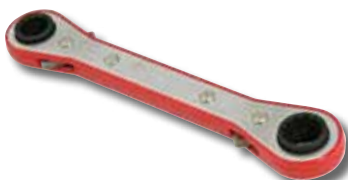

## Y Wrenches

Handy pocket sized Y-tools ideal for emergency repairs.

Order Code	Description
YWRSOC01	Socket head 8, 10, 12mm
YWRALL01	Allen head 4, 5, 6, 8mm



## Pocket Workshops

6pc stainless steel pocket tool with nylon carry pouch, comprises of pliers / cutter, screwdrivers, bottle opener, blade, file.

Order Code: **TLSSTS**



9pc pocket tool with carry pouch, includes file, screwdrivers, can opener, pliers / wire stripper, bottle opener and more.

Order Code: **TLSPOC**

Motorcycle  
Exhausts  
Screens  
Commuter  
Controls  
Headlights  
Indicators  
Mirrors  
Rear Lights  
Lifts & Stands  
Tools  
Batteries & Chargers  
Electrics  
Chain  
Servicing  
Tyres & Tubes  
Security  
Bike Accs  
Luggage  
Rider Accs  
Tank Pads  
Extras

MotoGP  
 Exhausts  
 Screens  
 Commuter  
 Controls  
 Headlights  
 Indicators  
 Mirrors  
 Rear  
 Lights  
 Lifts &  
 Stands  
**Tools**  
 Batteries &  
 Chargers  
 Electrics  
 Chain  
 Servicing  
 Tyres &  
 Tubes  
 Security  
 Bike  
 Accs  
 Luggage  
 Rider  
 Accs  
 Tank  
 Pads  
 Extras  
 www.bikekit.co.uk

## 24 LED Worklight

24 LED high intensity light. Hanging swivel hook and integral magnet for hands free use. Rubber finish for secure grip. CE & ROHS approved. Requires 3 x AA batteries (not included).  
**Order Code: TLSLED13**



**NEW**

## Hand Riveter

Heavy duty hand riveter supplied with a selection of rivets to fit the four interchangeable tips. A spanner is included to interchange the heads. Four different head sizes supplied 2.4, 3.2, 4.0, 4.8mm.  
**Order Code: TLSRV75**



## Rivet Packs

Replacement rivets suitable for all hand riveters

**NEW**

Order Code	Description
<b>TLRSVT10</b>	2.4mm (50pcs)
<b>TLRSVT12</b>	3.2mm (50pcs)
<b>TLRSVT14</b>	4.0mm (50pcs)
<b>TLRSVT16</b>	4.8mm (50pcs)
<b>TLRSVT18</b>	200pcs mixed sizes

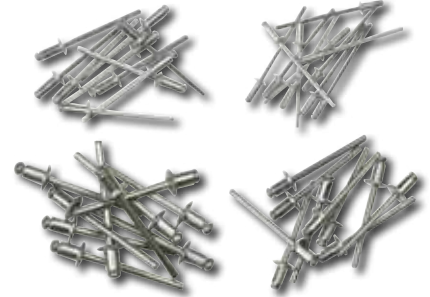

## Magnetic Pick Up Tool

Handy extendable reach tool with magnetic tip, ideal for picking up dropped bolts, washers etc. Extendable from 14cm to 56cm, with pen-type clip fastener.  
**Order Code: TLSMAG03**

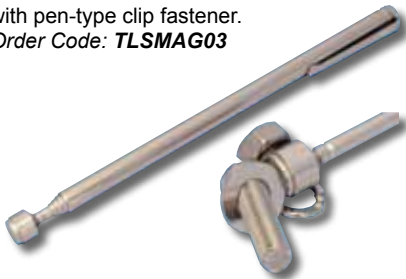

## Impact Driver Set

Impact driver set with two crosshead and two straighthead attachments  
**Order Code: TLSIMP**



## 1/2 Pint Oil Can

Handy sized oil can with robust pump mechanism and precision delivery spout.  
**Order Code: TLSOIL12**



\* Colour may vary

## Cable Ties

Order Code	Description
<b>CBT5BLK</b>	5" Black
<b>CBT5W</b>	5" White
<b>CBT7BLK</b>	7" Black
<b>CBT7W</b>	7" White

Order Code	Description
<b>CBT12BLK</b>	12" Black
<b>CBT12W</b>	12" White

**100 PIECE KIT**  
 100pcs cable ties in mixed sizes 180mm & 120mm in black and white  
**Order Code: CBTKIT01**



100 pc kit

**5", 7" and 12"**

20 pc pack



## Precision Mini Oiler

Pen sized oiler features internal reservoir. Thumb release button delivers lube to small and hard to reach parts.  
**Order Code: TLSOIL08**



## Rechargeable LED Work Light

- 27 LED Work Light
- Rechargeable & Cordless
- 240V charger
- 12V in-car charger
- Super bright and long life
- Swivel hanging hook
- Ideal for workshops and many other applications

**Order Code: TLSLED08**



**Ultra bright white LED's for maximum illumination.**



## Precision Mallet

Precision mallet with dual head of hard plastic and solid rubber. Perfect for precision and controlled hammering.  
**Order Code: TLSMLT40**



## Inspection Mirror

2" diameter inspection mirror. Mounted on a telescopic handle. Ideal for close-up viewing of hard to reach areas.

**Order Code: TLSINSM**

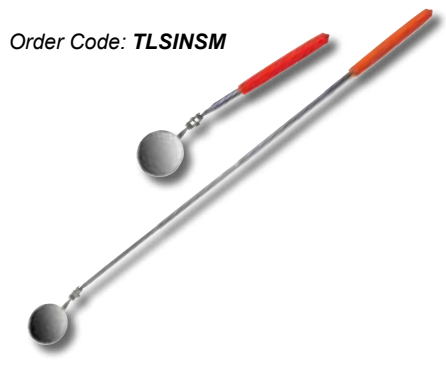



## Terminal Brush

Handy brush with four cleaning features. Cleans most battery terminals and connectors.

Order Code: **TLSSH08**



## Cable Lubricators

Order Code Colour

**CLBBU** Blue

**CLBBLK** Black & Gold

**CLBDUO** Dual Cable Oiler



## Emergency Cable Repair Kit

Emergency repair kit for temporary fixing of cables, includes 2 different coils of cable and selection of clamps, supplied in aluminium storage tin.

Order Code: **CRK009**



## 1000 Amp Digital Clamp Meter

This meter detects and measures the electrical field around a wire, without direct contact. It measures AC and DC volts. LCD display, AC current 0.1A to 1000A, AC voltage 1V to 750V, DC voltage 1V to 1000V. 54mm jaw opening.

Order Code: **TLSMET10**



## Safety Lock Wire Tool

Safety Lock Wire and tool. Ensures parts stay on vehicle. Quickly and neatly twists wire. A must for high vibration locations.

Order Code: **TLSWPL12**

**NEW**



## Spring Hook

16cm reach spring hook tool

Order Code: **HOOKSPR**



## Tailpipe Expander

A great device to play open and widen tubing and pipe work. 38 - 60mm range, use with socket or spanner.

Order Code: **TLSPIP07**



## Electrical Tool Kit

Comprehensive 399 pcs electrical tool kit. Includes neat storage carrier.

Contents include:

- 1 x Crimping Tool
- 1 x Insulation Tape
- 1 x Wire Cutter
- 1 x Tester
- 1 x Fuse Puller
- 1 x Long Nose Pliers
- 1 x Roll Primary Wire
- 30 x Auto Fuses
- 2 x Test Leads
- 2 x Screwdrivers
- 40 x PVC Magnetic Twist Tie
- 72 x Cable Ties
- 150 x Cable Ties
- 96 x Insulated Terminals

Order Code: **TLSELEC08**



## Lock Wire Dispenser

30m length of locking wire supplied in hand cassette dispenser.

**NEW**

Order Code: **TLSWPL14**



## Safety Lockwire Washers

18pc pack of safety lock wire washers, contains M6, M8 and M10

thread sizes. Install under bolt head and fold the tab upwards, enables multiple washers to be connected by safety lock wire.

Order Code: **BOLWSH13**

**NEW**



## Wire Pliers & Lock Wire

Order Code: Description

**TLSWPLIER** 9" safety lock wire pliers

**GRPWIRE** Stainless steel lock wire for use with wire pliers, ideal to secure grips etc. 0.7mm x 30m

**GRPW500** Lock wire reel - 0.8mm x approx 127m (500g)



## Caliper Pry Tool

Hand tool to pry open brake pads and calipers

Order Code: **TLSCPL14**



## Caliper Spreader

Threaded tool helping to spread brake caliper open for pad removal and install

Order Code: **TLSCPL12**



Motorcycle  
Exhausts  
Screens  
Commuter  
Controls  
Headlights  
Indicators  
Mirrors  
Rear Lights  
Lifts & Stands  
Tools  
Batteries & Chargers  
Electrics  
Chain  
Servicing  
Tyres & Tubes  
Security  
Bike Accs  
Luggage  
Rider Accs  
Tank Pads  
Extras

## Tirox 360 Chain Brush

Fast, easy and precise chain cleaning device. This chain brush simply twists around drive-chain, the bristles completely surrounding and contacting with chain, ensuring optimum 360 degree cleaning. Suitable for use with all chain sizes (415-630), O-Ring and X-Ring safe.

Order Code: **CHBBSH06**



## Chain Brush

Dual headed chain brush for easy agitation of dirt. Suitable for use with chain cleaners.

Order Code: **CHBBSH02**

### REPLACEMENT BRUSH BLADES

Order Code: **CHBBSH04**

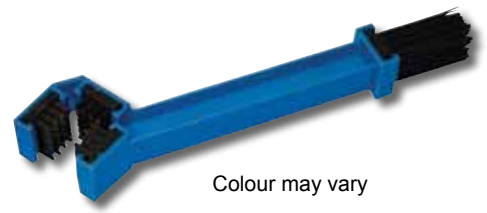

Colour may vary

## Chain Breakers

Order Code *Description*  
**CHBHD** Heavy duty type chain breaker, for all chain sizes

**CHBHDP** Pin for CHBHD

**CHBSTD** Standard type chain breaker

**CHBHDCH** Deluxe heavy duty chain breaker, with spare pin



## Chain Puller

Chain puller – assists in bringing chain ends together for linking

Order Code: **CHBPUL01**



## Chain Cutter & Riveter

Order Code: *Description*  
**CHBKIT** Heavy duty chain cutter and riveter  
 Fits all drive chains.

**CHBKITPIN** Heavy duty chain tool kit replacement pins 2.2mm, 2.9mm, 3.8mm, & riveter 5.5mm



## O-Ring Chain Assembly Tool

A simple vice with riveting bolt to assemble chain.

Order Code: **CHBASSY**



## Heavy Duty Chain Vice

This heavy weight tool will break, assemble and rivet chains for sizes HD 520, 525, 530 and 532

Order Code: **CHB001**

### REPLACEMENT PIN

Order Code: **CHB002**



## Chain Alignment Tool

Simple-use tool enables rear sprocket to be correctly aligned with chain  
 Helps prevent chain and sprocket wear

Order Code: **CHBALG10**

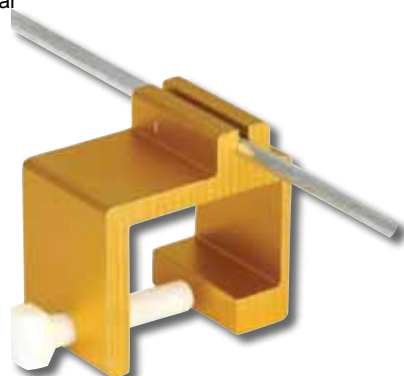



## Professional Chain Breaking & Riveting Kit

PROFESSIONAL CHAIN BREAKING & RIVETING KIT  
For all chains including: 520/525/530/532

Featuring a heavy duty head mechanism and jumbo sized handle, this chain tool makes easy work of breaking, plating and riveting motorcycle drive chains.

Order Code: **CHBPRO**

Replacement pins for Professional Chain Breaker CHBPRO

Order Code	Size
<b>CHBPROA3</b>	3mm
<b>CHBPROA4</b>	4mm
<b>CHBPROA5</b>	5mm



## Chain Spring-Link Pliers

Off-set ended pliers enable easy fitment and removal of chain spring-links. The shorter lip engages the chain pin, whilst the longer lip engages the retaining clip.

**NEW**

Order Code: **TLSPLO17**



## Workshop Chain Breaker & Assembler

WORKSHOP CHAIN BREAKER PRESS & RIVETER for all chains including: 520/525/530/532 chains  
Heavy duty chain tool for breaking, pressing and riveting motorcycle drive chains.

Tool can be secured using vice or spanner.  
Hexagon head shaft for socket head or spanner use

Order Code: **CHBWKS**

Replacement pins for Workshop Chain Breaker CHBWKS

Order Code	Size
<b>CHBWKSA3</b>	3mm
<b>CHBWKSA4</b>	4mm
<b>CHBWKSA5</b>	5mm



## Chain Cleaning Kit

This kit features a cassette housing which clamps around drive chain, internal brushes clean debris and dirt from the chain as it is pulled through. Chain cleaner can be fed into the cassette from the top feed tube, dirty cleaner exiting from the drain tube. Includes cord and hooks enabling attachment to bike whilst in use, and plastic drainage/cleaner bottle.

Order Code	Description
<b>CHBCLE06</b>	Chain Cleaning Kit
<b>CHBCLE08</b>	Replacement brushes

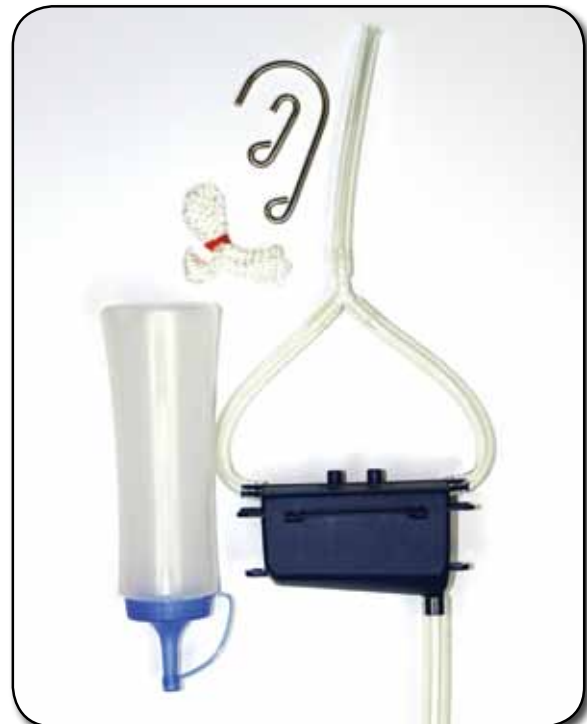

Motorcycle  
Exhausts  
Screens  
Commuter  
Controls  
Headlights  
Indicators  
Mirrors  
Rear Lights  
Lifts & Stands  
**TOOLS**  
Batteries & Chargers  
Electrics  
Chain  
Servicing  
Tyres & Tubes  
Security  
Bike Accs  
Luggage  
Rider Accs  
Tank Pads  
Extras

**Motorcycle**  
**Exhausts**  
**Screens**  
**Commuter**  
**Controls**  
**Headlights**  
**Indicators**  
**Mirrors**  
**Rear Lights**  
**Lifts & Stands**  
**Tools**  
**Batteries & Chargers**  
**Electrics**  
**Chain**  
**Servicing**  
**Tyres & Tubes**  
**Security**  
**Bike Accs**  
**Luggage**  
**Rider Accs**  
**Tank Pads**  
**Extras**  
[www.bikekit.co.uk](http://www.bikekit.co.uk)

## Vacuum Gauges

Vacuum gauges enable easy synchronisation and balancing of motorcycle carburettors for 4 cylinder and 2 cylinder machines. Each unit includes precision gauges mounted on a robust metal base for workshop use, threaded brass carb extensions (65mm and 180mm), connectors and vacuum hose.

Order code	Description
VGA2	2 cylinder gauge
VGA4	4 cylinder gauge
VGA6	Replacement connectors (4pcs)
VGA8	Replacement extensions (4pcs)

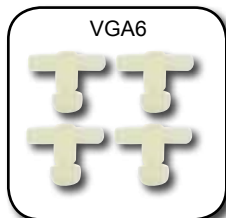

## Float Level Gauge

Measures the float height level between float and carburettor gasket

Order Code: **TLSCRB14**



## Carburettor Adjusting Tool

Long reach tool with hexnut and screwdriver slot end, aids easy carb adjustment, suitable for use on most Japanese multi-cylinder engines.

Order Code: **CRBTOOL**



## Deluxe 4pc Pick Set

Set of 4 hook and pick tools for variety of intricate applications such as removal of oil seals, O-rings, pull springs and cotter pins, making punch holes. Features selection of sharp ends and contour handles.

**NEW**

Order Code: **TLSPIC13**



## Oil Seal Puller

Dual hooked-tip tool allows removal of hard-to-reach seals without damaging housing or bearings.

**NEW**

Order Code: **TLSPUL13**



## Precision Scrapers

3pc set of scraping tools with various shape and size heads, makes quick and accurate work of gasket removal and preparation, adhesive and dirt removal etc.

Order Code: **TLSKNF03**





## Mechanic Stethoscope

Quickly locates the source of engine noise such as piston slap, worn gears and bearings, damaged valves, water pump failure, and blown gaskets.

Order Code: **TLSSTH12**

**NEW**



## Brake Caliper Piston Tool

Specific handtool for holding and detaching brake pistons, grabs brake caliper pistons internally enabling seized pistons to be worked free.

Order Code: **TLSHOL49**



## Combination Wrench Set

Premium quality 17pc metric chrome vanadium combination wrench set. Each wrench is precision manufactured to DIN 3113 specification, featuring one open and one offset ring end. Supplied in storage tray designed for tool chest shelving. Includes ones of each wrench size 6-22mm.

Order Code: **TLSET16**



**NEW**

## Flywheel & Clutch Pulley Holder

This adjustable pulley holder is suitable for flywheel and clutch pulleys. Adjustable from 70-125mm with lockable adjuster bolt. Non-slip coated handle for safety and comfort.

Order Code: **TLSHOL07**



## Flywheel & Clutch Pulley Holder

This adjustable pulley holder is suitable for flywheel and clutch pulleys. Features an adjustable foot which locates onto pulley, 45-120mm. Non-slip coated foot and strap ensure optimum pulley grip.

Order Code: **TLSHOL28**



## Pulley Wrench

This wrench is designed to lock V-belt pulleys in place so they can be removed and fitted, has many automotive applications including belt driven scooters.

Order Code: **TLSHOL42**



## Flywheel Puller

This puller enables removal of tapered lock rings on most magento flywheels. Includes the most popular 6 sizes;

- M10x1.25R
- M14x1.5R
- M16x1.5R
- M18x1.5R
- M24x1.0R
- M27x1.0L

Order Code: **TLSPFLY35**



Motorcycle  
Exhausts  
Screens  
Commuter  
Controls  
Headlights  
Indicators  
Mirrors  
Rear  
Lights  
Lifts &  
Stands  
Tools  
Batteries &  
Chargers  
Electrics  
Chain  
Servicing  
Tyres &  
Tubes  
Security  
Bike  
Accs  
Luggage  
Rider  
Accs  
Tank  
Pads  
Extras

## Adjustable Fork Oil Seal Driver

Universal tool to safely and simply install fork oil seals into forks, without causing damage to the new oil seals or fork stanchions. Adjustable from 39 – 50mm

Order Code: **TLSFRK11**

**NEW**



## Bearing Packer

Compact unit which connects to grease gun (not supplied) and injects grease into bearing units, completing the job quickly and cleanly. Suitable for bearing diameters 50-95mm. Complete with dust cover for clean storage after use.

Order Code: **TLSBEA02**

**NEW**



## Air Shock Pumps

Aluminium barrelled premium hand-pumps for air shock inflation, both feature pressure dials for accurate measurement.

**NEW**

Order Code	Description
<b>PMP009</b>	Universal valve, 300PSI
<b>PMP011</b>	Universal valve, 300PSI, removable gauge



## Steering Head Cup Remover

Steering head cup tool ensures accurate and simple steering head bearing race/cup removal. The flared end-section locates on the internal lip of the race/cup, the opposite end is then hammered to remove the race/cup.

**NEW**

Order Code	Description
<b>TLSRMV02</b>	28-32mm
<b>TLSRMV04</b>	38-55mm



## Universal Shock Wrench

Order Code	Size
<b>SHKWRE</b>	69-76mm & 89-96mm
<b>SHKWRE01</b>	38-45mm & 45-52mm



## Graduated Workshop Syringe

60ml graduated workshop syringe. Many applications such as brake bleeding and fork oil adjustment.

Order Code: **TLSYR11**



## Front Oil Level Adjuster

Features level adjuster mounted on filler probe and graduated syringe. Makes easy work of precision fork oil adjustment.

Order Code: **TLSFRK07**



MotoGP  
Exhausts  
Screens  
Commuter  
Controls  
Headlights  
Indicators  
Mirrors  
Rear Lights  
Lifts & Stands  
Tools  
Batteries & Chargers  
Electrics  
Chain  
Servicing  
Tyres & Tubes  
Security  
Bike Accs  
Luggage  
Rider Accs  
Tank Pads  
Extras  
www.bikekit.co.uk



## Tool Boxes

Durable plastic tool boxes with tough closure clasp and carry handle. Each includes a removable inner shelf and external top storage for tools and small parts.

Order code    Size  
**TLSCAB09**    15litre (43x18x20cm)  
**TLSCAB11**    4.5litre (29x13x12cm)



TLSCAB09



TLSCAB11



**NEW**

## Key Safe Store

Metal storage unit for keeping keys safe. Features hinged front cover with lock, internal divider and 93 loops for hanging keys. Wall mountable. Unit size 24x30x8cm.

Order Code:  
**TLSCAB07**

**NEW**



## Folding Kit Cart

- Versatile folding trolley for storing and moving motorcycle kit and tools
- 35kg load capacity
- Lightweight collapsible design, for easy storage
- Telescopic aluminium handle
- Expanded dimension 42 x 40.5 x 33cm
- Folded dimension 42 x 40.5 x 8cm
- Rubberised wheels

Order Code: **TLSCRT35**



## Tool Chest & Cabinet

Mechanics steel combination tool chest and cabinet set.

Lower unit features two drawers and large capacity storage compartment with up-and-over door. Tool chest features multiple lockable drawers plus lid.

Tool chest can be placed in storage compartment. Width 616mm x depth 330mm x height 1070mm

Order Code: **TLSCAB03**



## Mobile Workstation

Steel mobile workstation and tool storage unit. Features lower shelf for open storage of tools and cleaning products. Two storage shelves set on smooth ball-bearing mechanism. Top work surface has durable inlay for grip and protection, the surface slides outwards to expose lockable internal storage compartment. Mounted on sturdy 1" casters with brakes for easy movement. Assembled size 705x370x830mm

Order Code: **TLSCAB05**

**NEW**



Motocp  
 Exhausts  
 Screens  
 Commuter  
 Controls  
 Headlights  
 Indicators  
 Mirrors  
 Rear Lights  
 Lifts & Stands  
**TOOLS**  
 Batteries & Chargers  
 Electrics  
 Chain  
 Servicing  
 Tyres & Tubes  
 Security  
 Bike Accs  
 Luggage  
 Rider Accs  
 Tank Pads  
 Extras

MotoGP  
 Exhausts  
 Screens  
 Commuter  
 Controls  
 Headlights  
 Indicators  
 Mirrors  
 Rear Lights  
 Lifts & Stands  
**Tools**  
 Batteries & Chargers  
 Electrics  
 Chain  
 Servicing  
 Tyres & Tubes  
 Security  
 Bike Accs  
 Luggage  
 Rider Accs  
 Tank Pads  
 Extras  
 www.bikekit.co.uk

### KTM/Euro MX Hardware Mini Kit

This 50pcs kit includes the perfect assortment of metric bolts, nuts, cotter pins, washers and specific hardware for KTM/Euro off-road and MX bikes.

**NEW**

Order Code: **BOLKIT15**



### Japanese MX Hardware Mini Kit

This 50pcs kit includes the perfect assortment of factory sized metric bolts, nuts, cotter pins, washers and specific hardware for Honda, Kawasaki, Suzuki and Yamaha off-road and MX bikes.

**NEW**

Order Code: **BOLKIT12**



### Rivet Push Pin Kit

This 80pcs kit includes an assortment of nylon rivet push pins for use on panels and fairings. Includes M6, M7 and M8 sizes.

**NEW**

Order Code: **BOLRVT02**



### ATV / Quad Hardware Kit

This 188pcs kit includes the perfect assortment of factory sized flange/allen/button bolts, nuts, screws, cotter pins and specific hardware for Honda, Kawasaki, Suzuki and Yamaha ATVs.

**NEW**

Order Code: **BOLKIT06**



### KTM/Euro MX Hardware Kit

This 158pcs kit includes the perfect assortment of metric bolts, nuts, cotter pins, washers and specific hardware for KTM/Euro off-road and MX bikes.

**NEW**

Order Code: **BOLKIT03**



### Fairing Bolt Kit

This 160pcs kit includes the perfect assortment of M5 and M6 metric button head bolts and washers for fairing fitment.

**NEW**

Order Code: **BOLKIT18**



### Sportsbike Hardware Kit

This 258pcs kit includes the perfect assortment of factory sized flange/allen/button bolts, nuts, screws and specific hardware for Honda, Kawasaki, Suzuki and Yamaha sportsbikes.

**NEW**

Order Code: **BOLKIT01**



### Japanese MX Hardware Kit

This 170pcs kit includes the perfect assortment of factory sized metric bolts, nuts, cotter pins, washers and specific hardware for Honda, Kawasaki, Suzuki and Yamaha off-road and MX bikes.

**NEW**

Order code: **BOLKIT09**



### Compartment Store

Plastic storage compartment 205mm (W) x 100mm (L) x 27mm (D). 6 internal compartments with 2 removable dividers to make 6, 12 or 18 compartment combinations. Hinged securing lid. Perfect for storing bolts, washers, nuts, fuses etc.

Order Code: **TLSCOMP**



Contents not included



## 141pc Rubber Washer Assortment

Selection of rubber and fibre washers in a storage case.  
Order Code: **ASST03**



## 500pc Cotter Pin Assortment

A wide selection of pins for all securing needs. Complete with a storage case.  
Order Code: **ASST12**



## Scotch Lock Wire Connectors

Push fit connector for easy and tidy connection of electrical wires. Ideal for installing indicators, rear lights etc. Pack of 10 connectors.  
Order Code: **ASST24**

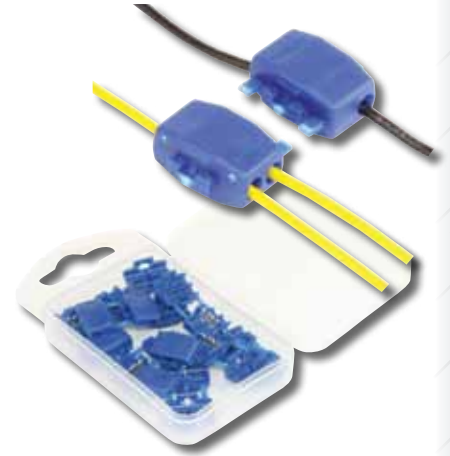

## 100pc Nylon Locknut Assortment

Nylon insert works as a lock washer to keep fasteners secure in high-vibration applications. Zinc-plated to resist corrosion. Selection of 6, 8, 10, 12mm in a plastic storage case.  
Order Code: **ASST06**



## 180pc Terminal Assortment

Heavy plastic sleeves provide insulation and keeps wires from flexing. Popular sizes fit a variety of applications when adding or replacing electrical accessories.  
Order Code: **ASST18**



## Insulation Tape

Pack of 10 rolls  
Order Code Colour  
**INTBLK** Black  
**INTR** Red  
**INTBU** Blue  
**INTYE** Yellow



## Masking Tape

White masking tape roll- 20mm x 50m  
Order Code: **MKTW**

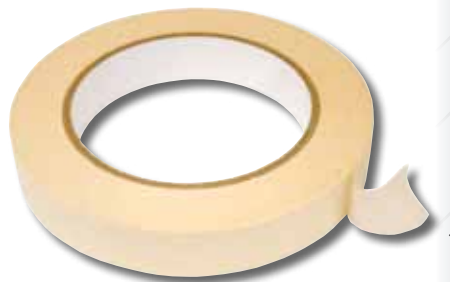

## 150pc R-Clip Assortment

A complete collection of replacement R-Clips in six sizes included in a plastic storage case.  
Order Code: **ASST09**



## 127pc Heat Shrink Wire Wrap Assortment

Contains 7 popular sizes, complete with sectioned storage case. When heated, these sleeves shrink around wiring for optimum connection and insulation.  
Order Code: **ASST21**



## Duct Tape

50mm x 50m  
Order Code Colour  
**DCTBLK** Black  
**DCTSIL** Silver



Motocp  
Exhausts  
Screens  
Commuter  
Controls  
Headlights  
Indicators  
Mirrors  
Rear Lights  
Lifts & Stands  
**TOOLS**  
Batteries & Chargers  
Electrics  
Chain  
Servicing  
Tyres & Tubes  
Security  
Bike Accs  
Luggage  
Rider Accs  
Tank Pads  
Extras

## Tiedown Straps

A selection of tiedown straps for safely securing vehicles in transit and storage, available in varying webbing sizes, ratchet and auto-lock combinations.

Order Code	Qty	Type	Colour	Breaking Strength	Hook
TIE2AUTO	2	Autolock 1.8m x 25mm	Red	400kgs	S
TIE4AUTO	4	Autolock 1.8m x 25mm	Red	400kgs	S
TIE2RAT	2	Ratchet 5m x 25mm	Blue	500kgs	S
TIE4RAT	4	Ratchet 5m x 25mm	Blue	500kgs	S
TIERATPRO	1	Ratchet Pro 2.4m x 50mm	Red	1375kgs	Claw
TIERAT08	2	Ratchet Jumbo 3m x 30mm	Green	1375kgs	Claw



TIERATPRO



TIERAT08



TIE2RAT



TIE2AUTO



## Tiedown Shrouds

Protect fairings and bodywork from abrasion when using tie-downs. Bespoke neoprene sleeves wrap and fasten around the tie-down webbing strap. The shrouds can then be adjusted along the tie-down to contact points between bike and webbing. Supplied in pairs. Available for 25, 30 and 50mm width straps.

Order Code	Width
TIE2SHR	25mm
TIE2SRA	30mm
TIE2SRB	50mm

**NEW**



## Micro Tiedown Straps

TUV approved micro webbing strap with auto-lock mechanism. Ideal for additional strapping of motorcycles and vehicles in transit and storage.

- 25mm wide, 2.5m long
- 200kgs capacity
- Supplied in pairs

Order Code: **TIE2MIC**



## Quick Release Tiedown Anchors

This pair of stainless-steel anchors consist of 2 base mounting blocks and quick-release anchor-loops.

The mounting blocks should be drill mounted to wood or metal surfaces, such as van floor or side wall, providing a sturdy fixing point for the quick-release anchors.

The anchors attach by a simple but strong spring mechanism, ready to secure tie-down straps or ropes to the strong loops.

When not in use, the anchor-loops can be easily removed leaving just the flush-fitting mounting blocks – preventing nasty snags and scrapes

Order Code: **TIE2ANC**



MotoGP  
Exhausts  
Screens  
Commuter  
Controls  
Headlights  
Indicators  
Mirrors  
Rear Lights  
Lifts & Stands  
Tools  
Batteries & Chargers  
Electrics  
Chain  
Servicing  
Tyres & Tubes  
Security  
Bike Accs  
Luggage  
Rider Accs  
Tank Pads  
Extras  
www.bikeit.co.uk



## Lever Jammer 2

Additional securing device for use when transporting motorcycles. The jammer attaches over the brake lever and throttle grip, engaging the front brake of the motorbike. Prevents movement of the front wheel whilst being transported.

Order Code: **LEVJMR**

**NEW**



## Bar Support Straps

Nylon webbing strap with grip cuffs. Fits across handlebars to provide anchor points for tie-down straps to secure bike in transit.

Order Code: **TIEBAR**



## Easy Loops

Pair of 45cm long nylon tie down extensions, eliminates direct contact between metal tie down hooks and motorcycle. Prevents damage and scratching from metal hooks.

Order Code: **TIEEASY**



## Lever Jammer

Lever Jammer is an additional securing device for use when transporting motorcycles, locking the front brake of the bike to prevent potential movement of the front wheel when on a truck or van. The Lever Jammer, a strong neoprene strap with D-clip, wraps around the throttle grip and closed brake lever and secures fast to keep the lever depressed and front brake locked on. Lever Jammers should be used in conjunction with other securing products such as tie-down straps and shrouds.

Order Code: **LEVJAM**



- Motocp
- Exhausts
- Screens
- Commuter
- Controls
- Headlights
- Indicators
- Mirrors
- Rear Lights
- Lifts & Stands
- Tools
- Batteries & Chargers
- Electrics
- Chain
- Servicing
- Tyres & Tubes
- Security
- Bike Accs
- Luggage
- Rider Accs
- Tank Pads
- Extras

# Super Performance Lithium Ion Batteries

The latest in motorcycle battery technology, Lithium Ion batteries are the lightest and most environmentally friendly options on the market.

More than 65% weight saving of normal lead-acid type batteries, makes Lithium Ion batteries perfect for track and race bikes where weight reduction is an enhancement.

Unique casing design with spacers for exact height adjustment, cases are same size as the original battery that is being replaced.

**Less volume and weight** – 1/3 of equivalent model normal lead-acid batteries

**No pollution** – contains no acid or heavy metals such as lead, cadmium, mercury

**Non-spilling** – contains no acid

**Super cranking power** – greater cranking power (40CA+)

**Increased safety** - non-polluting, non-explosive and non-combustable.

**Excellent cycle life** - 2000+ charging cycles

**Easy charging** - Any standard 12v motorcycle battery charger can be used with Lithium Ion Batteries.



## Li-PO replacements for Dry Charge (12N) batteries

Order Code	Replaces
LIPO05B	12N5.5-3B
LIPO05B	12N5-3B
LIPO09C	12N7-4A
LIPO09C	12N7-4B
LIPO09C	12N9-4B-1
LIPO12E	12N12A-4A-1
LIPO14C	12N14-3A

## Li-PO replacements for Dry Charge (CB/YB) batteries

Order Code	Replaces
LIPO05B	CB4L-A
LIPO05B	CB4L-B
LIPO05B	CB5L-B
LIPO09C	CB7-A
LIPO09C	CB9A-A
LIPO09C	CB9-B
LIPO12E	CB10A-A2
LIPO12F	CB10L-A2
LIPO12F	CB10L-B2
LIPO12E	CB12A-A
LIPO12E	CB12A-B
LIPO12F	CB12AL-A
LIPO12F	CB12AL-A2
LIPO12C	CB12B-B2
LIPO14C	CB14L-A2
LIPO14C	CB14L-B2
LIPO12A	CB16A-LA2
LIPO20A	CB16CL-B
LIPO20A	CB16L-B
LIPO20A	CB18L-A2
LIPO20A	C50-N18L-A2
LIPO20A	C50-N18L-A3

## Li-PO replacements for Maintenance Free (DTX/YTX) batteries

Order Code	Replaces
LIPO04A	YTX4L-BS
LIPO05A	YTX5L-BS
LIPO07C	YTX7A-BS
LIPO07B	YTX7L-BS
LIPO09A	YTX9-BS
LIPO12C	YTX12A-BS
LIPO12A	YTX12B-BS
LIPO12C	YTX12-BS
LIPO14C	YTX14AHL-BS
LIPO14A	YTX14-BS
LIPO14C	YTX14L-BS
LIPO20A	YTX15L-BS
LIPO20A	YTX20HL-BS
LIPO20A	YTX20L-BS
LIPO20A	YTX24HL-BS

## Li-PO replacements for Sealed Activated (MG/YT) batteries

Order Code	Replaces
LIPO05A	YTZ5-S
LIPO07A	YTZ7-S
LIPO09B	YT7B-BS
LIPO09B	YT9B-4
LIPO09B	YT9B-BS
LIPO09A	YTR9-BS
LIPO10A	YT10B-4
LIPO10A	YTZ10-S
LIPO12D	YT12A-BS
LIPO12A	YT12B-BS
LIPO12B	YTZ12-S
LIPO12A	YT14B-BS
LIPO14B	YTZ14-S

## Intelligent Lithium Ion Battery Charger

- A fully automatic intelligent charger designed specifically for use only with 12V Lithium Ion motorcycle batteries.
- This 12V 2Amp charger will take full care of Lithium Ion batteries, maximising battery power and life
- Recovers deep discharged batteries
- Features UK 3-pin plug
- Supplied with interchangeable crocodile and ring terminal leads

**NEW**



Order Code: **LIPOBCH**

MotorGP  
Exhausts  
Screens  
Commuter  
Controls  
Headlights  
Indicators  
Mirrors  
Rear Lights  
Lifts & Stands  
Tools  
Batteries & Chargers  
Electrics  
Chain  
Servicing  
Tyres & Tubes  
Security  
Bike Accs  
Luggage  
Rider Accs  
Tank Pads  
Extras  
www.bikekit.co.uk





## Dynavolt Batteries

Dynavolt is an established and recognised OEM motorcycle battery manufacturer, the batteries are also the approved after sales battery to several top Japanese and European motorcycle manufacturers.

Bike It customers can now benefit from this superior range with the reassurance of an OEM product, superior build quality and guaranteed performance.

**GEL NANOTECHNOLOGY**  
**CONVENTIONAL SEALED-ACTIVATED**  
**MAINTENANCE FREE WITH ACID PACKS**  
**HIGH PERFORMANCE DRY CHARGE**  
**CONVENTIONAL DRY CHARGE**



## Maintenance Free With Acid Packs (DTX Series)

Valve regulated lead acid batteries once activated, are totally sealed. This eliminates spills and leakages, making them particularly suitable for motorcycles, ATVs and personal watercraft. Each battery is supplied with an easy-fill acid pack for activation, no further maintenance or topping up is required. Robust and vibration resistant, maintenance free batteries last up to three times longer than conventional batteries.

Order Code	Dynavolt Ref	Alt. Ref
YTX4LBS	DTX4L-BS	YTX4L-BS
YTX5LBS	DTX5L-BS	YTX5L-BS
YTX7ABS	DTX7A-BS	YTX7A-BS
YTX7LBS	DTX7L-BS	YTX7L-BS
YTX9BS	DTX9-BS	YTX9-BS
YTX9LBS	DTX9L-BS	YTX9L-BS
YTX12ABS	DTX12A-BS	YTX12A-BS
YTX12BBS	DTX12B-BS	YTX12B-BS
YTX12BS	DTX12-BS	YTX12-BS
YTX12LBS	DTX12L-BS	YTX12L-BS
YTX14BS	DTX14-BS	YTX14-BS
YTX14LBS	DTX14L-BS	YTX14L-BS
YTX14L2	DTX14AHLBS	YTX14-L2
YTX15L-BS	DTX15L-BS	YTX15L-BS
YTH1612	DTH16-12	YTH16-12
YTX16BS	DTX16-BS	YTX16-BS
YTX16LBS	DTX16L-BS	YTX16L-BS
YTX20ABS	DTX20ABS	YTX20A-BS
YTX20HLBS	DTX20HLBS	YTX20HL-BS
YTX20LBS	DTX20-LBS	YTX20-LBS
YTX20BS	DTX20-BS	YTX20-BS
YTX24HLBS	DTX24-HLBS	YTX24-HLBS



Motocp  
 Exhausts  
 Screens  
 Computer  
 Controls  
 Headlights  
 Indicators  
 Mirrors  
 Rear Lights  
 Lifts & Stands  
 Tools  
 Batteries & Chargers  
 Electrics  
 Chain  
 Servicing  
 Tyres & Tubes  
 Security  
 Bike Accs  
 Luggage  
 Rider Accs  
 Tank Pads  
 Extras

## Gel Nanotechnology (MG Series)

### High Performance MG...

Dynavolt offer an advanced range of sealed activated models (MG). Utilising a real gel electrolyte, rather than liquid, the Nano-Gel is able to fully cover the active material all the time, providing a larger effective surface area and prevent lead from sulphation. The nature of Nano-Gel provides maximum holding to the plates which is able to withstand severe vibration and prolong battery life.

Significantly, true gel MG batteries offer more battery cycles and longer shelf life, compared to other factory-activated batteries on the market.

Order Code	Dynavolt Ref	Alt. Ref
<b>MG4ABS</b>	MG4ABS	YTX4A-BS
<b>MG4BBS</b>	MG4BBS	YTX4B-BS / YT4B-5
<b>MG51913</b>	MG51913	51913
<b>MG6ZS</b>	MG6ZS	YTZ6-S
<b>MG7B4</b>	MG7B4	YT7B-4
<b>MG7ZS</b>	MG7ZS	YTZ7-S
<b>MG9B4</b>	MG9B4	YT9B-4
<b>MG10ZS</b>	MG10ZS	YT10B-4 / YT10-ZS
<b>MG1218</b>	MG1218	SLA12-18
<b>MG12ABS</b>	MG12ABS	YT12A-BS
<b>MG12B4</b>	MG12B4	YT12B-4
<b>MG12ZS</b>	MG12ZS	YTZ12-S
<b>MG14B4</b>	MG14B4	YT14B-4
<b>MG14ZS</b>	MG14ZS	YTZ14-S
<b>SLA1222</b>	MG1222	SLA12-22



## Gel Nanotechnology Upgrades

### MG versions of DTX and DB models.

Dynavolt have taken some of the most popular maintenance free and conventional battery models (eg DTX9BS and DB4L-B) and developed upgrade batteries using MG technology. These upgrade batteries offer improved battery performance over the original battery type, and as they are factory sealed and activated they do not require acid-filling to commission.



### GEL NANO UPGRADE - DTX Series

Order Code	Upgrade from	Alt. Ref
<b>MG4LBS</b>	DTX4L-BS	YTX4L-BS
<b>MG5LBS</b>	DTX5L-BS	YTX5L-BS
<b>MG7ABS</b>	DTX7A-BS	YTX7A-BS
<b>MG7LBS</b>	DTX7L-BS	YTX7L-BS
<b>MG9BS</b>	DTX9-BS	YTX9-BS
<b>MG12BS</b>	DTX12-BS	YTX12-BS
<b>MG14BS</b>	D TX14-BS	YTX14-BS
<b>MG30LBS</b>	YIX30L	N/A

### GEL NANO UPGRADE - DB Series

Order Code	Upgrade from	Alt. Ref
<b>MGCB4LB</b>	DB4L-B	YB4L-B
<b>MGCB5LB</b>	DB5L-B	YB5L-B
<b>MGCB9B</b>	DB9-B	YB9-B
<b>MGCB12AA</b>	DB12A-A	YB12A-A
<b>MGCB14LA2</b>	DB14L-A2	YB14L-A2
<b>MGCB16ALA2</b>	DB16AL-A2	YB16AL-A2
<b>MGC50N18LA2</b>	D50-N18L-A2	Y50-N18L-A2

## Conventional Sealed Activated Batteries

Dynavolt factory-activated sealed batteries are supplied pre-charged and require no acid-filling to commission. This range is targeted as direct standard replacement for OE batteries fitted to the majority of the latest motorcycles.

Order Code	Dynavolt Ref	Alt. Ref
<b>MGS6ZS</b>	MGS6ZS	YTZ6-S
<b>MGS7B4</b>	MGS7B4	YT7B-4
<b>MGS7ZS</b>	MGS7ZS	YTZ7-S
<b>MGS9B4</b>	MGS9B4	YT9B-4
<b>MGS10ZS</b>	MGS10ZS	YT10B-4/YT10Z-S
<b>MGS12ABS</b>	MGS12ABS	YT12-ABS
<b>MGS12B4</b>	MGS12B4	YT12B-4
<b>MGS12ZS</b>	MGS12ZS	YTZ12-S
<b>MGS14B4</b>	MGS14B4	YT14B-4
<b>MGS14ZS</b>	MGS14ZS	YTZ14-S



MotoGP  
 Exhausts  
 Screens  
 Commuter  
 Controls  
 Headlights  
 Indicators  
 Mirrors  
 Rear Lights  
 Lifts & Stands  
 Tools  
 Batteries & Chargers  
 Electrics  
 Chain  
 Servicing  
 Tyres & Tubes  
 Security  
 Bike Accs  
 Luggage  
 Rider Accs  
 Tank Pads  
 Extras  
 www.bikeit.co.uk



## High Performance Dry Charge (DB Series)

20-30% more starting power than conventional batteries, more plates per cell give higher cranking performance. Extra power for machines with additional electrical components or high compression engines.

Order Code	Dynavolt Ref	Alt. Ref	ACID Packs Req.	Order Code	Dynavolt Ref	Alt. Ref	ACID Packs Req.
CB25LC	DB25L-C	YB2.5L-C	1	CB14B2	DB14-B2	YB14-B2	3
CB3LA	DB3L-A	YB3L-A	1	CB14LA2	DB14L-A2	YB14L-A2	3
CB3LB	DB3L-B	YB3L-B	1	CB14LB2	DB14L-B2	YB14L-B2	3
CB4LA	DB4L-A	YB4L-A	1	HCB16AA	HDB16A-A	HYB16A-A	3
CB4LB	DB4L-B	YB4L-B	1	CB16ALA2	DB16AL-A2	YB16AL-A2	3
CB5LB	DB5L-B	YB5L-B	1	CB16BA	DB16B-A	YB16B-A	3
CB7A	DB7-A	YB7-A	2	CB16B	DB16-B	YB16-B	4
CB7CA	DB7C-A	YB7C-A	2	CB16CLB	DB16CL-B	YB16CL-B	4
CB7LB2	DB7L-B2	CB7L-B2	2	CB16LB	DB16L-B	YB16L-B	4
CB9AA	DB9A-A	YB9A-A	2	CB18LA2	DB18L-A2	YB18L-A2	3
CB9B	DB9-B	YB9-B	2	CB30CLB	DB30CL-B	YB30CL-B	4
CB9LA2	DB9L-A2	YB9L-A2	2	C50N18LA2	D50-N18L-A2	Y50-N18L-A2	4
CB9LB	DB9L-B	YB9L-B	2	C50N18LA3	D50-N18L-A3	Y50-N18L-A3	4
CB10AA2	DB10A-A2	YB10A-A2	2	C60N24ALB	D60-N24AL-B	Y60-N24AL-B	5
CB10LA2	DB10L-A2	YB10L-A2	2	C60N30LA	D60-N30L-A	Y60-N30L-A	5
CB10LB2	DB10L-B2	YB10L-B2	2	UI9	UI-9	UI-9	6
CB12AA	DB12A-A	YB12A-A	3	UIR9	UI-R9	UI-R9	6
CB12AB	DB12A-B	YB12A-B	3				
CB12ALA	DB12AL-A	YB12AL-A	3				
CB12ALA2	DB12AL-A2	YB12AL-A2	3				
CB12BB2	DB12B-B2	YB12B-B2	2				
CB14A2	DB14-A2	YB14-A2	3				
CB14AA2	DB14A-A2	YB14A-A2	3				

Supplied dry without electrolyte.  
Order electrolyte packs as detailed.



## Conventional Dry Charge (6N & 12N Series)

Standard replacement dry charge batteries. General dependable power. High cranking power

Order Code	Dynavolt. Ref	ACID Packs Req.	Order Code	Dynavolt. Ref	ACID Packs Req.
6CB83B	6DB8-3B	1	B396	B39-6	1
6N112D	6N11-2D	2	B496	B49-6	2
6N11A1B	6N11A-1B	2	12N53B	12N5-3B	2
6N11A4	6N11A-4	2	12N553B	12N5.5-3B	2
6N11A4A	6N11A-4A	2	12N554A	12N5.5-4A	2
6N12A2C	6N12A-2C	1	12N554B	12N5.5-4B	2
6N12A2D	6N12A-2D	1	12N55A3B	12N5.5A-3B	2
6N22A	6N2-2A	1	12N73A	12N7-3A	2
6N22A8	6N2-2A-8	1	12N73B	12N7-3B	2
6N42A	6N4-2A	1	12N74A	12N7-4A	2
6N42A2	6N4-2A-2	1	12N74B	12N7-4B	2
6N42A4	6N4-2A-4	1	12N93B	12N9-3B	2
6N42A5	6N4-2A-5	1	12N94B1	12N9-4B-1	2
6N42A7	6N4-2A-7	1	12N113A1	12N11-3A-1	2
6N4A4D	6N4A-4D	1	12N12A4A1	12N12A-4A-1	2
6N4B2A	6N4B-2A	1	12N143A	12N14-3A	3
6N4B2A3	6N4B-2-A3	1	12C16A3B	12D16A-3B	3
6N4B2A4	6N4B-2A-4	1	12N183A	12N18-3A	4
6N551D	6N5.5-1D	1	12N243	12N24-3	5
6N61B	6N6-1B	1	12N244	12N24-4	5
6N61C	6N6-1C	1			
6N61D2	6N6-1D-2	1			
6N63B	6N6-3B	1			
6N63B1	6N6-3B-1	1			
B386A	B386-A	2			

Supplied dry without electrolyte.  
Order electrolyte packs as detailed.



## Dynavolt Catalogue

A totally comprehensive application guide detailing the full range of Dynavolt.



Order Code: **DYNACAT02**

## Dry Charge Acid Packs

1.270sg electrolyte suitable for dry charge batteries

Order Code	Description
ACID	Single acid pack 400cc
ACIDBOT01	1 litre bottle



ACID



ACIDBOT01

Motorcycle  
Exhausts  
Screens  
Commuter  
Controls  
Headlights  
Indicators  
Mirrors  
Rear Lights  
Lifts & Stands  
Tools  
Batteries & Chargers  
Electrics  
Chain  
Servicing  
Tyres & Tubes  
Security  
Bike Accs  
Luggage  
Rider Accs  
Tank Pads  
Extras

## 6/12V Battery Charger

A simple and very effective charger for all 6V/12V lead acid, sealed, VRLA and GEL batteries.

Supplied with interchangeable crocodile and ring terminal leads

- Trickle-charge function ensures battery is constantly maintained
- Auto-stop prevents overcharging
- 6V/12V 1A
- Solid state dual colour LED indicator
- Reverse polarity protection
- Spark proof
- Fireproof plastic enclosure

Order Code: **BCH012**



## 9 Stage 12V Battery Charger with Battery Recovery

A fully automatic 12V 1A charger with a 9 stage charge programme. Battery Recovery function maximises potential of badly maintained batteries. Suitable for all 12V lead acid, sealed, VRLA and GEL batteries. Supplied with interchangeable crocodile and ring terminal leads

- Fully automatic charging and maintenance
- Spark proof
- Reverse polarity protection
- Fireproof plastic housing
- Short circuit protection
- LED indicator display
- 12V 1A

Order Code: **BCH014**



## 4 Stage 6V / 12V Automatic Battery Charger

A fully automatic charger that detects 6V and 12V batteries. Microprocessor controlled. 4 stage charge programme. Suitable for all 6V / 12V lead acid, sealed, VRLA and GEL batteries. Supplied with interchangeable crocodile and ring terminal leads

- Fully automatic charging and maintenance
- Spark proof
- Reverse polarity protection
- Fireproof plastic housing
- LED indicator display
- 6V 0.8A / 12V 3.8A

Order Code: **BCH016**



## BikeTek PRO-3 Diagnostic Battery Charger

12V 1A Battery Charger. Fully Automatic diagnostic charger and maintainer. Suitable for all 12V batteries including lead-acid, sealed lead acid and gel-filled.

Features:

- Reverse Polarity Protection
- Identifies and recovers deeply discharged batteries
- Short circuit protection
- Thermal protection
- Over-charge prevention
- Interchangeable connection leads
- LED status indicators
- Suitable for medium to longterm charging
- Charge battery whilst still connected to vehicle
- Includes interchangeable leads (crocodile clamp and terminal type)

Order Code: **BCH001**

**LEADS**

Order Code Description

**BCHCON03** Terminal Leads (Female)

**BCHCON04** Crocodile Leads (Female)





## BikeTek Battery Chargers

BikeTek chargers offer a simple and effective motorcycle battery charging solution. Each charger is supplied with two connector leads, "Crocodile" and "Terminal", which have a male connector block. This block simply plugs into the female block of the charger unit, offering quick and versatile connection. Crocodile leads simply clip to the battery terminals and are suitable for worktop charging. Terminal leads can be permanently connected to the battery terminals whilst fitted on the motorcycle eliminating the need for battery removal. Spare leads are available separately to enable one charger to be used on multiple bikes.

Order Code Description

- BCH2PIN** European 2 pin plug, 12v  
**BCH3PIN** UK 3 pin plug, 12v/6v selectable  
**ACEURO** European 2 pin plug adaptor (Converts UK 3 pin plug to Euro 2 pin)  
**ACFRA** French plug multi-adaptor, converts 3 plugs to 1, CE approved

### LEADS

- BCHCON01** Terminal Leads (Male)  
**BCHCON02** Crocodile Leads (Male)



## Terminal Adaptors

Order Code: **BATADAPTOR**



## Motorcycle Booster Cable

- Ideal for emergency use in Motorcycles and small vehicles
- Light weight, easier for storage
- For 6V and 12V batteries
- Length: 1.5M
- Copper area: 6mm<sup>2</sup>
- Amps: 30 amp

Order Code:  
**BCHCON07**



## Battery and Charging System Voltage Tester

- Tests voltage of all 12V lead acid, sealed, VRLA and GEL batteries
- Rainbow indicator shows state of charge
- Good / Bad alternator test

Order Code: **BCH018**



## Battery Filler

This oversized dropper has a 175ml bulb, allowing electrolyte to be taken up and injected into dry battery cells simply and safely.

Order Code: **ACDFLL13**

**NEW**



## Acid Filler Funnel

Plastic tapered funnel makes adding electrolyte to dry-charge batteries simple and safe.

Order Code: **ACDFNL**



## Battery & Alternator Tester

Biketek battery and alternator tester monitors the charge state of 12V batteries and alternator system, showing results with a simple traffic light display. Connecting to the battery by terminal leads, the unit will give a Poor, Fair or Good reading of battery state, and an indication of the operating status of the alternator when the engine is running. The unit is IP65 water-proof, allowing it to be permanently connected to the motorcycle if required. Ensures quick and easy battery monitoring, prompting good battery maintenance and extending battery life.

Unit size: L56 x W45 x H21mm

Battery State:

- No LED – FAULTY battery (<11.6V)
- Red LED – POOR battery (11.6V+)
- Yellow LED – FAIR battery (12.0V+)
- Green LED – GOOD battery (12.5V+)

Alternator Function:

- Green LED – Charging system working well (13.5V detected)

Order Code: **BCH020**

**NEW**



Motocp  
 Exhausts  
 Screens  
 Commuter  
 Controls  
 Headlights  
 Indicators  
 Mirrors  
 Rear Lights  
 Lifts & Stands  
 Tools  
 Batteries & Chargers  
 Electrics  
 Chain  
 Servicing  
 Tyres & Tubes  
 Security  
 Bike Accs  
 Luggage  
 Rider Accs  
 Tank Pads  
 Extras

MotoGP  
Exhausts  
Screens  
Commuter  
Controls  
Headlights  
Indicators  
Mirrors  
Rear Lights  
Lifts & Stands  
Tools  
Batteries & Chargers  
Electrics  
Chain  
Servicing  
Tyres & Tubes  
Security  
Bike Accs  
Luggage  
Rider Accs  
Tank Pads  
Extras  
www.bikeit.co.uk

## Twinz 12V Horns

Twin packs of 12V snail-style horns 130dB, High and Low tones. Includes mounting kit Use individually or as pair. 3 colour options to choose from.

Order Code	Colour
HORTBLK	Solid Black
HORTBU	Translucent Blue
HORTR	Translucent Red



## Horns

Order Code	Description
HORS6V	6V alloy horn, 70mm diameter, 100db
HORS12V	12V alloy horn, 70mm diameter, 100db
HORL12VBLK	12V black horn, 100mm diameter, 110db
HOR12VR	Red coloured horn, 12v, 110db, 90mm
HOR12VBU	Blue coloured horn, 12v, 110db, 90mm
HOR12VGD	Gold coloured horn, 12v, 110db, 90mm
HOR12VCH	Chrome horn, 12V, 110 db, 100mm diameter
HOR12VCHS	Chrome slitted horn, 12V, 110 db, 100mm diameter



## Indicator Relays

### UNIVERSAL

Order Code	V	W	Pins	Size
WRE01*	6	8/10	2	Small
WRE02*	12	8/10	2	Small
WRE03*	6	18/23	2	Small
WRE04*	12	18/23	2	Small
WRE05*	6	18/23	3	Small
WRE06*	12	18/23	3	Small
WRE08	12	18/23	2	Medium
WRE09	6	18/23	2	Large

### OEM

WRE11*	Yamaha DT50
WRE12*	Yamaha TZR125
WRE14*	Honda 12.8v 23(21)x2+3.4w CBR600, CBR900, CBR1100, VFR750, VTR1000 etc

\*Complete with Rubber Holder



## LED Indicator Relays

LED indicators work to a lower wattage than standard bulb-type indicators. It may be necessary therefore to replace the existing relay with a specially designed LED relay with the correct wattage.

Order Code	Description
WRELED01	2 pin Universal
WRELED02	3 pin Universal
WRELED03	OEM Block type Fits most Honda, Kawasaki, Yamaha
WRELED05	7 pin Suzuki OEM block type, 12V



## LED Indicator Resistor

An easy alternative to installing an LED indicator relay, these resistors are simply connected in series to each indicator, creating correct indicator flash rate without needing to replace the OE relay. Each indicator requires 1 resistor. Sold individually.

Order Code:  
**WRELED04**

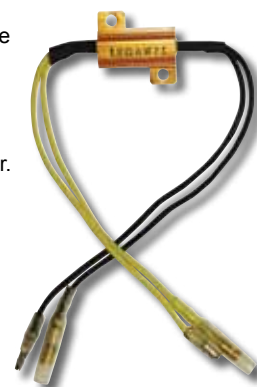



## Fuses & Holders

### Blade Fuses (per 10)

Order Code	Amps	Width
FUS3B	3	Standard
FUS5B	5	Standard
FUS75B	7.5	Standard
FUS10B	10	Standard
FUS15B	15	Standard
FUS20B	20	Standard
FUS25B	25	Standard
FUS30B	30	Standard
FUS3BS	3	Small
FUS5BS	5	Small
FUS75BS	7.5	Small
FUS10BS	10	Small
FUS15BS	15	Small
FUS20BS	20	Small
FUS25BS	25	Small
FUS30BS	30	Small

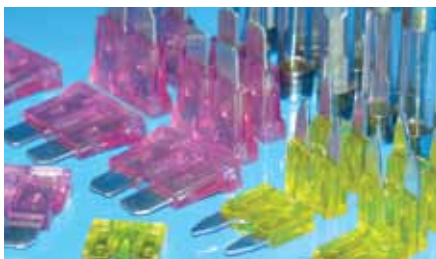

### Glass Fuses (per 10)

Order Code	Amps	Length
FUS725G	7	25mm
FUS1025G	10	25mm
FUS1525G	15	25mm
FUS2025G	20	25mm
FUS2525G	25	25mm
FUS3025G	30	25mm
FUS730G	7	30mm
FUS1030G	10	30mm
FUS1530G	15	30mm
FUS2030G	20	30mm
FUS3030G	30	30mm

### Fuse Holders (per 10)

#### Order Code Description

**FUSUNIH** Plastic in-line fuse holders

**FUSPIGH** Plastic in-line fuse holders  
Piggy back style with spare fuse.

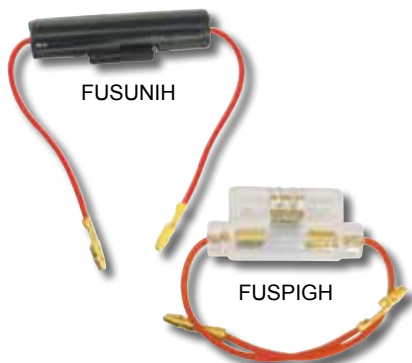

## HT Lead Connector

Order Code: **HTC01**



## Oil Pressure Switches

#### Order Code Description

**OPS012** M10 1.25MM Gold  
**OPS015** M10 1.00MM Silver



## Rectifiers, Regulators & Solenoids

#### Order Code OEM Equivalent Models

#### HONDA

**RECCB** 31600-413-008 CB250/400N (Inc. Regulator), CB450DX, XBR500

**RECH001** 31600-MV4-000

#### SUZUKI

#### RECSUZ

TS50/AP50/CS/CL50/FR50/80/ZR50/OR50/  
GP/TS100 GT/TS125/TS125X/TS185.

#### YAMAHA

**RECY001** 47X-81960-A21/2FZR400/600/750/100 XJ600

#### UNIVERSAL

**REC6V** Universal 6V. (Per 10)

**RECSLN02** 12V Universal Starter Solenoid



\* Use of OEM codes for comparative use only

## Plug Caps

#### Order Code Description

**PLCRUB** Universal black rubber plug cap  
(Per card of 10)

**PLCCX** CX500 Long plug cap (1 pc)



## Ignition Coils

#### Order Code Description

**IGC01** Ignition coil 6V

**IGC02** Ignition coil 12V

**IGC08** Ignition coil Suzuki GS550



## Stop/Kill Switches

#### Order Code Description

**BUTWP** Universal Waterproof stop switch

**BUTWP10** Universal 10 pieces waterproof stop switch

**BUTH** Chrome horn button

**BUTH10** 10 pieces chrome horn button

**BUT2TOG** Universal 2 position toggle switch (on/off)

**BUT3TOG** Universal 3 position toggle switch

**SSUBRIT** Universal British type stop switch

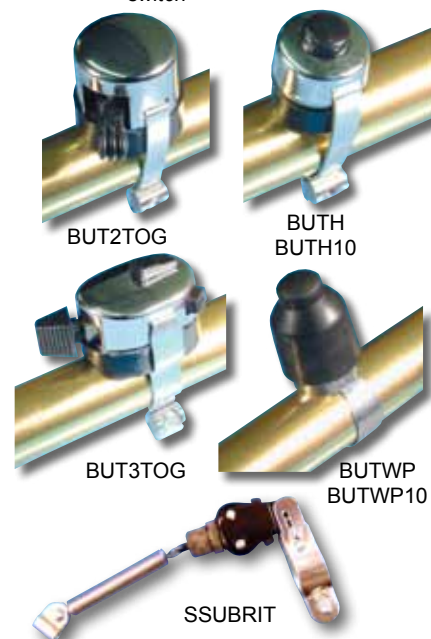

Motorcycle  
Exhausts  
Screens  
Commuter  
Controls  
Headlights  
Indicators  
Mirrors  
Rear Lights  
Lifts & Stands  
Tools  
Batteries & Chargers  
Electricity  
Chain  
Servicing  
Tyres & Tubes  
Security  
Bike Accs  
Luggage  
Rider Accs  
Tank Pads  
Extras

## Bar Switches

Order Code	Description
BUTKILL03	Universal kill switch with On/Off function
BUTKILL07	Universal kill switch with Hi/Lo beam and On/Off function
BUTSWT12	Universal ATV switch with horn, indicators, hazards and LED function

For Off Road and ATV kill switches see Off Road section.



## Clutch Switches

Order Code	Description
SSKC01	Kawasaki type (27010-1094)
SSKC02	Kawasaki type (27010-1406, 27010-1171)
SSSC01	Suzuki type (57560-14F00)
SSSC02	Suzuki type (37560-38A00)
SSYC01	Yamaha type (36Y-83917-00, 36Y-82917-00)
SSYC02	Yamaha type (3YX-82917-00)



## Front Stop Light Switches

Order Code	Description
SSHF01	Honda type (35340-422-013)
SSHF02	Honda type (35340-MA5-670)
SSHF03	Honda type (35330-413-003)
SSUF02	Honda type (35335-MCJ-750)
SSKF01	Kawasaki type (27010-1170)
SSKF02	Kawasaki type (27010-1492)
SSKF03	Kawasaki type (27010-1056)
SSSF01	Suzuki type (57460-17C00)
SSSF02	Suzuki type (46-50810, 57460-49100)
SSSF04	Suzuki type (35330-MBO-003, 57560-02FAO)
SSSF05	Suzuki type (57560-05A00, 27010-1268)
SSUF02	Yamaha type (4XV-82917-01)
SSYF01	Yamaha type (45J-82503-01-00, 367-83980-01)
SSYF03	Yamaha type (4BH-83980-00)
SSYF04	Yamaha type (4HM-83980-00)
SSYF05	Yamaha type (31A-82917-00)



## Rear Stop Light Switches

Order Code	Description
SSHR01	Honda type
SSSR01	Suzuki type
SSYR01	Yamaha type
SSYR02	Yamaha DT50/80MX type (also fits Suzuki)
SSUR10	Universal type, card of 10pcs
SSURM10	Mixed types, card of 10pcs (4 x Honda, 4 x Suzuki, 2 x Yamaha)



MIXED CARD OF 10 SWITCHES ALSO AVAILABLE:

SSURM10 Mixed card of 10 switches, 2 x Yamaha, 4 x Suzuki, 4 x Honda

## Universal Front Stop Switches

Order Code	Description
SSHF04	Honda type
SSPF01	Piaggio type
SSSF03	Suzuki type
SSYF02	Yamaha type
SSUF01	Universal scooter type
SSUF08	Universal scooter type
SSUF10	Universal type, card of 10pcs
SSUSCOOT	Universal scooter type

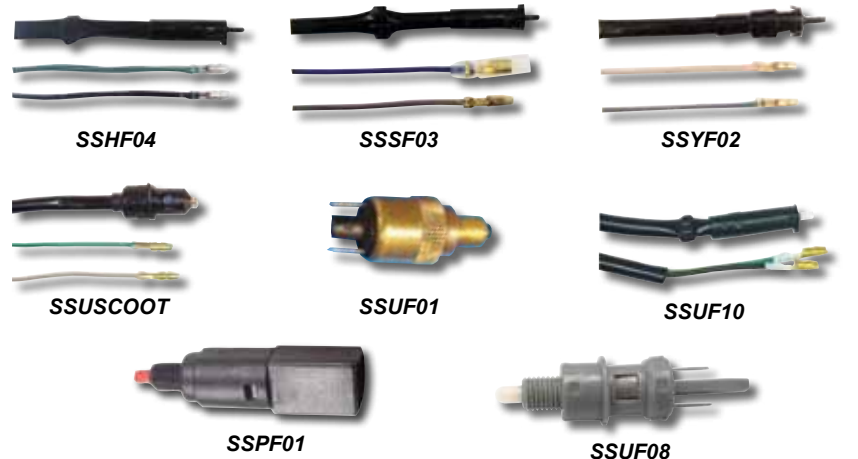

MotoGP  
Exhausts  
Screens  
Commuter  
Controls  
Headlights  
Indicators  
Mirrors  
Rear Lights  
Lifts & Stands  
Tools  
Batteries & Chargers  
Electrics  
Chain  
Servicing  
Tyres & Tubes  
Security  
Bike Accs  
Luggage  
Rider Accs  
Tank Pads  
Extras  
www.bikekit.com





# Triple SSS Chains *the Driving Force*

Triple-S chains have been developed with the input and support over the years of professional Yamaha race teams in World MX, British Superbikes & British Supersport.

Ongoing rigorous and extensive testing with these Yamaha squads gives Triple-S the race proven knowledge to pass on to the customer a superb range of chains.

The Triple-S range of standard, heavy duty, solid bush, O-ring and X-ring chains may not bring you the British Titles and World Championship race wins of the Yamaha UK teams, but it will give you the reassurance on the road and track that you have an excellent product keeping you in front.





## Standard - Triple S Chains

Standard grade motorcycle drive chain available in 420, 428, 520 and 530 sizes.

Triple-S Standard chains offer all the performance required from smaller capacity motorcycles requiring this grade of roller chain.

Produced in an OE facility, Triple S Standard chains are quality engineered and manufactured to guarantee trouble free strength and durability.

### Order Code Length

420 Standard	
CHS420078	420-78L
CHS420084	420-84L
CHS420086	420-86L
CHS420096	420-96L
CHS420098	420-98L
CHS420100	420-100L
CHS420102	420-102L
CHS420104	420-104L
CHS420106	420-106L
CHS420108	420-108L
CHS420110	420-110L
CHS420112	420-112L
CHS420114	420-114L
CHS420116	420-116L
CHS420118	420-118L
CHS420120	420-120L
CHS420122	420-122L
CHS420124	420-124L
CHS420126	420-126L
CHS420130	420-130L
CHS420136	420-136L
CHS420250*	420 (600L) x 25' roll

### Order Code Length

428 Standard	
CHS428100	428-100L
CHS428102	428-102L
CHS428104	428-104L
CHS428106	428-106L
CHS428108	428-108L
CHS428110	428-110L
CHS428112	428-112L
CHS428114	428-114L
CHS428116	428-116L
CHS428118	428-118L
CHS428120	428-120L
CHS428122	428-122L
CHS428124	428-124L
CHS428126	428-126L
CHS428128	428-128L

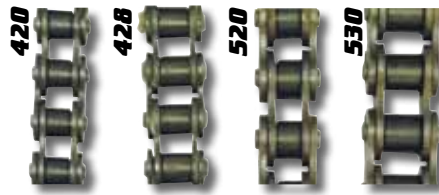

### Order Code Length

#### 428 Standard cont...

CHS428130	428-130L
CHS428132	428-132L
CHS428134	428-134L
CHS428136	428-136L
CHS428138	428-138L
CHS428250*	428 (600L) x 25' roll

#### 520 Standard

CHS520102	520-102L
CHS520104	520-104L
CHS520106	520-106L
CHS520108	520-108L
CHS520110	520-110L
CHS520112	520-112L
CHS520114	520-114L
CHS520116	520-116L
CHS520118	520-118L
CHS520120	520-120L
CHS520122	520-122L
CHS520130	520-130L
CHS520250*	520 (480L) x 25' roll

#### 530 Standard

CHS530100	530-100L
CHS530102	530-102L
CHS530104	530-104L

### Order Code Length

530 Standard cont...	
CHS530106	530-106L
CHS530108	530-108L
CHS530110	530-110L
CHS530112	530-112L
CHS530114	530-114L
CHS530116	530-116L
CHS530120	530-120L
CHS530250*	530 (480L) 25' roll

\* 25' rolls exclude connecting links

## Connecting Links

Packs of spare connecting links for Triple-S chain, available in spring-clip and rivet link types.

Order Code	Type	Qty
CHLSS420	420 Spring	10pcs
CHLSS428	428 Spring	10pcs
CHLSS520	520 Spring	10pcs
CHLSS530	530 Spring	10pcs
CHLRS420	420 Rivet	10pcs
CHLRS428	428 Rivet	10pcs
CHLRS520	520 Rivet	10pcs
CHLRS530	530 Rivet	10pcs



## Heavy Duty - Triple S Chains

### Order Code Length

415 Heavy Duty	
CHH415120	415H-120L

### Order Code Length

420 Heavy Duty	
CHH420120	420H-120L
CHH420126	420H-126L
CHH420130	420H-130L

### Order Code Length

428 Heavy Duty	
CHH428104	428H-104L
CHH428106	428H-106L
CHH428108	428H-108L
CHH428110	428H-110L
CHH428112	428H-112L
CHH428114	428H-114L
CHH428116	428H-116L
CHH428118	428H-118L
CHH428120	428H-120L
CHH428122	428H-122L
CHH428124	428H-124L
CHH428126	428H-126L
CHH428128	428H-128L
CHH428130	428H-130L
CHH428132	428H-132L
CHH428134	428H-134L
CHH428136	428H-136L
CHH428138	428H-138L
CHH428140	428H-140L
CHH428142	428H-142L
CHH428146	428H-146L
CHH428250*	428H (600L) 25' roll

### Order Code Length

520 Heavy Duty	
CHH520100	520H-100L
CHH520102	520H-102L
CHH520104	520H-104L
CHH520106	520H-106L
CHH520108	520H-108L
CHH520110	520H-110L
CHH520112	520H-112L
CHH520114	520H-114L
CHH520116	520H-116L
CHH520118	520H-118L
CHH520120	520H-120L

Heavy Duty grade motorcycle drive chain available in 415, 420, 428, 520, 525 and 530 sizes. Triple-S Heavy Duty chains offer all the performance required from road and off-road motorcycles requiring this grade of roller chain.

Produced in an OE facility, Triple S Heavy Duty chains are quality engineered and manufactured to guarantee trouble free strength and durability.



### Order Code Length

#### 520 Heavy Duty cont...

CHH520130	520H-130L
CHH520250*	520H (480L) 25' roll

#### 525 Heavy Duty

CHH525102	525H-102L
CHH525104	525H-104L
CHH525106	525H-106L
CHH525108	525H-108L
CHH525110	525H-110L
CHH525114	525H-114L
CHH525118	525H-118L
CHH525120	525H-120L
CHH525128	525H-128L

#### 530 Heavy Duty

CHH530098	530H-98L
CHH530100	530H-100L
CHH530102	530H-102L
CHH530104	530H-104L
CHH530106	530H-106L
CHH530108	530H-108L
CHH530110	530H-110L
CHH530112	530H-112L
CHH530114	530H-114L
CHH530116	530H-116L
CHH530118	530H-118L
CHH530120	530H-120L
CHH530250*	530H (480L) 25' roll

\* 25' rolls exclude connecting links

## Connecting Links

Packs of spare connecting links for Triple-S chain, available in spring-clip and rivet link types.

Order Code	Type	Qty
CHLSH415	415H Spring	10pcs
CHLSH420	420H Spring	10pcs
CHLSH428	428H Spring	10pcs
CHLSH520	520H Spring	10pcs
CHLSH525	525H Spring	10pcs
CHLSH530	530H Spring	10pcs
CHLRH415	415H Rivet	10pcs
CHLRH420	420H Rivet	10pcs
CHLRH428	428H Rivet	10pcs
CHLRH520	520H Rivet	10pcs
CHLRH525	525H Rivet	10pcs
CHLRH530	530H Rivet	10pcs



MotoGP  
 Exhausts  
 Screens  
 Commuter  
 Controls  
 Headlights  
 Indicators  
 Mirrors  
 Rear Lights  
 Lifts & Stands  
 Tools  
 Batteries & Chargers  
 Electrics  
 Chain  
 Servicing  
 Tyres & Tubes  
 Security  
 Bike Accs  
 Luggage  
 Rider Accs  
 Tank Pads  
 Extras  
 www.bikeit.co.uk



## Solid Bush - Triple S Chains

Solid Bush motorcycle drive chain available in Standard 420, Heavy Duty 428 and 520 sizes. Solid Bush chains utilise the same links and rollers as the equivalent Standard or Heavy Duty chains, but use a solid bushing instead of a split bushing inside the roller. This solid bushing increases wear resistance of the chain and minimises chain elongation, making the chains a worthy upgrade. Suitable for road and off-road applications. Produced in an OE facility, quality engineered and manufactured to guarantee trouble free strength and durability.

### Order Code Length

420 Solid Bush Standard	
CHU420078	420-78L
CHU420090	420-90L
CHU420110	420-110L
CHU420120	420-120L
CHU420126	420-126L

### 428 Solid Bush Heavy Duty

CHU428100	428-100L
CHU428114	428-114L
CHU428116	428-116L
CHU428118	428-118L
CHU428120	428-120L
CHU428122	428-122L
CHU428124	428-124L
CHU428130	428-130L
CHU428134	428-134L
CHU428138	428-138L
CHU428142	428-142L

### 520 Solid Bush Heavy Duty

CHU520100	520-100L
CHU520110	520-110L
CHU520112	520-112L
CHU520114	520-114L
CHU520116	520-116L
CHU520120	520-120L
CHU520130	520-130L

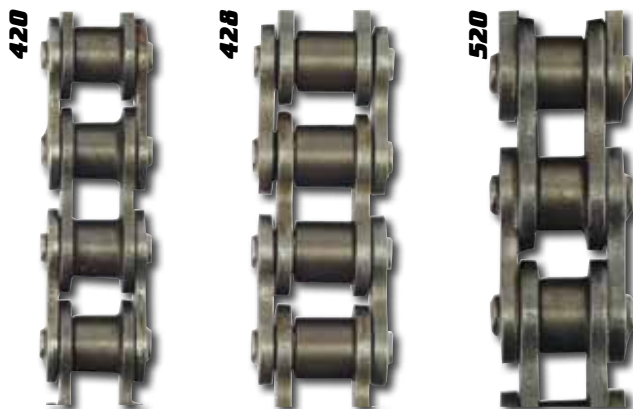

### Connecting Links

Packs of spare connecting links for Triple-S chain, available in spring-clip and rivet link types.

Order Code	Type	Qty
CHLSU420	420 Spring	10pcs
CHLSU428	428 Spring	10pcs
CHLSU520	520 Spring	10pcs
CHLRU420	420 Rivet	10pcs
CHLRU428	428 Rivet	10pcs
CHLRU520	520 Rivet	10pcs

Rivet Link



Spring Link



## O-Ring Black

Heavy duty O-Ring grade motorcycle drive chain available in 428 and 520 sizes. Featuring a rubber O-ring between the inner and outer link, O-Ring chains both retain the lubricant sealed within the pin and bushing and prevent dirt working into the chain, prolonging chain longevity. Triple-S O-Ring chains offer all the performance required from larger capacity road and off-road motorcycles requiring this grade of roller chain. Produced in an OE facility, Triple S O-Ring chains are quality engineered and manufactured to guarantee trouble free strength and durability. Nickel plate finish.

### Order Code Length

428 O-Ring Black	
CHK428100	428-100L
CHK428104	428-104L
CHK428108	428-108L
CHK428110	428-110L
CHK428112	428-112L
CHK428114	428-114L
CHK428116	428-116L
CHK428118	428-118L
CHK428120	428-120L
CHK428122	428-122L
CHK428124	428-124L
CHK428126	428-126L
CHK428128	428-128L
CHK428130	428-130L
CHK428132	428-132L
CHK428134	428-134L
CHK428136	428-136L
CHK428138	428-138L
CHK428140	428-140L
CHK428142	428-142L

### Order Code Length

520 O-Ring Black	
CHK520098	520-98L
CHK520100	520-100L
CHK520102	520-102L
CHK520104	520-104L
CHK520106	520-106L
CHK520108	520-108L
CHK520110	520-110L
CHK520112	520-112L
CHK520114	520-114L
CHK520116	520-116L
CHK520118	520-118L
CHK520120	520-120L



### Connecting Links

Packs of spare connecting links for Triple-S chain, available in spring-clip and rivet link types.

Order Code	Type	Qty
CHLSK428	428	5pcs
CHLSK520	520	5pcs
CHLRK428	428	5pcs
CHLRK520	520	5pcs

Rivet Link



Spring Link



Motorcycle  
Exhausts  
Screens  
Commuter  
Controls  
Headlights  
Indicators  
Mirrors  
Rear Lights  
Lifts & Stands  
Tools  
Batteries & Chargers  
Electrics

Chain

Servicing

Tires & Tubes

Security

Bike Accs

Luggage

Rider Accs

Tank Pads

Extras

www.bikeit.co.uk

MotoGP  
 Exhausts  
 Screens  
 Commuter  
 Controls  
 Headlights  
 Indicators  
 Mirrors  
 Rear Lights  
 Lifts & Stands  
 Tools  
 Batteries & Chargers  
 Electrics  
 Chain  
 Servicing  
 Tyres & Tubes  
 Security  
 Bike Accs  
 Luggage  
 Rider Accs  
 Tank Pads  
 Extras  
 www.bikekit.co.uk

## O-Ring Gold - Triple S Chains

These chains incorporate a rubber O-shaped seal that fits between the inner and outer links. This seal ensures that the grease between the pin and solid bush is retained and offers permanent internal lubrication. With the dual purpose of stopping dirt working into the chain, the seals help prolong the life of the chain.

Order Code	Length
<b>420 Extra Heavy DUTY</b>	
CHO420130	420XHO-130L
CHO420132	420XHO-132L
CHO420136	420XHO-136L
CHO420142	420XHO-142L

Order Code	Length
<b>520 Extra Heavy DUTY</b>	
CHO520098	520XHO-98L
CHO520102	520XHO-102L
CHO520104	520XHO-104L
CHO520106	520XHO-106L
CHO520108	520XHO-108L
CHO520110	520XHO-110L
CHO520112	520XHO-112L
CHO520114	520XHO-114L
CHO520116	520XHO-116L
CHO520118	520XHO-118L
CHO520120	520XHO-120L
CHO52075*	520XHO-473L (7.5m roll)

Order Code	Length
<b>525 Extra Heavy DUTY</b>	
CHO525108	525XHO-108L
CHO525110	525XHO-110L
CHO525112	525XHO-112L
CHO525114	525XHO-114L
CHO525116	525XHO-116L
CHO525118	525XHO-118L
CHO525120	525XHO-120L
CHO525122	525XHO-122L
CHO525124	525XHO-124L
CHO525128	525XHO-128L
CHO52575*	525XHO-473L (7.5m roll)



Order Code	Length
<b>530 Extra Heavy DUTY</b>	
CHO530104	530XHO-104L
CHO530106	530XHO-106L
CHO530108	530XHO-108L
CHO530110	530XHO-110L
CHO530112	530XHO-112L
CHO530114	530XHO-114L
CHO530116	530XHO-116L
CHO530118	530XHO-118L
CHO530120	530XHO-120L
CHO530130	530XHO-130L
CHO53075*	530XHO-473L (7.5m roll)

\* 7.5m rolls exclude connecting links

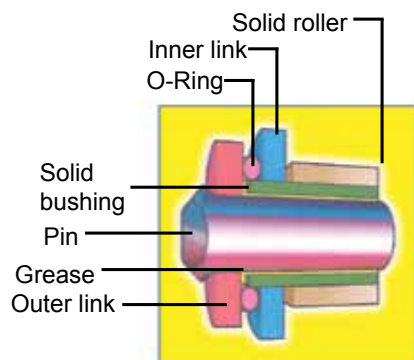

## Connecting Links

Packs of spare connecting links for Triple-S chain, available in spring-clip and rivet link types.

Order Code	Type	Qty
CHLSO420	420XHO spring	5pcs
CHLSO520	520XHO spring	5pcs
CHLSO525	525XHO spring	5pcs
CHLSO530	530XHO spring	5pcs
CHLRO420	420XHO rivet	5pcs
CHLRO520	520XHO rivet	5pcs
CHLRO525	525XHO rivet	5pcs
CHLRO530	530XHO rivet	5pcs



## X-Ring Gold - Triple S Chains

In these chains an X-shaped rubber seal is fitted between the inner and outer links, the extra two points against the links retain internal grease and stop dirt entering. With characteristic lower friction levels and increased running performance over O-ring chains, X-ring chains are recommended for higher powered and touring bikes.

Order Code	Length
<b>520 Extra Heavy DUTY</b>	
CHX520104	520XHX-104L
CHX520108	520XHX-108L
CHX520110	520XHX-110L
CHX520112	520XHX-112L
CHX520114	520XHX-114L
CHX520116	520XHX-116L
CHX520118	520XHX-118L
CHX520120	520XHX-120L

Order Code	Length
<b>525 Extra Heavy DUTY</b>	
CHX525096	525XHX-96L
CHX525106	525XHX-106L
CHX525108	525XHX-108L
CHX525110	525XHX-110L
CHX525112	525XHX-112L
CHX525114	525XHX-114L
CHX525118	525XHX-118L
CHX525120	525XHX-120L
CHX525124	525XHX-124L
CHX525128	525XHX-128L

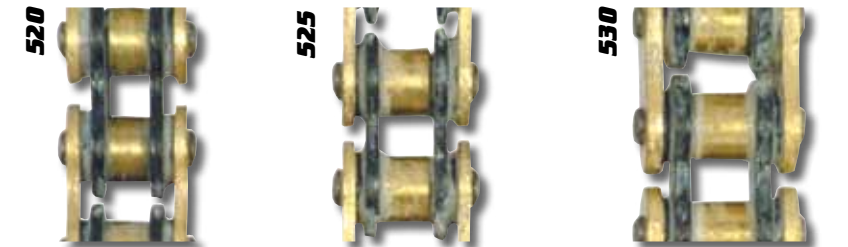

Order Code	Length
<b>530 Extra Heavy DUTY</b>	
CHX530102	530XHX-102L
CHX530104	530XHX-104L
CHX530106	530XHX-106L
CHX530108	530XHX-108L
CHX530110	530XHX-110L
CHX530112	530XHX-112L
CHX530114	530XHX-114L
CHX530116	530XHX-116L
CHX530118	530XHX-118L
CHX530120	530XHX-120L
CHX530122	530XHX-122L
CHX530130	530XHX-130L

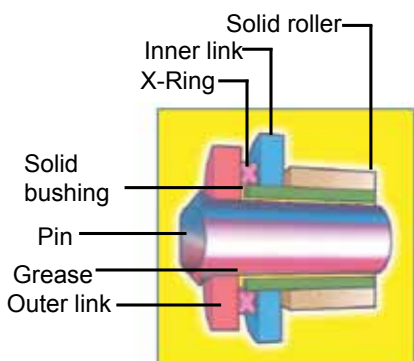

## Connecting Links

Packs of spare connecting links for Triple-S chain, available in spring-clip and rivet link types.

Order Code	Type	Qty
CHLSX520	520XHX spring	5pcs
CHLSX525	525XHX spring	5pcs
CHLSX530	530XHX spring	5pcs
CHLRX520	520XHX rivet	5pcs
CHLRX525	525XHX rivet	5pcs
CHLRX530	530XHX rivet	5pcs



## Cam Chain - Triple S Chains

Order Code	Length
CHC25084	25H-84L
CHC25098	25H-98L
CHC25100	25H-100L
CHC25104	25H-104L



# Chain & Sprocket Kits

A winning combination of two proven products - Triple S chain and JT sprockets. Triple S chain, as used by and developed by Team Yamaha UK's Superbike and MX teams, is the perfect replacement chain for today's motorcycles. Available in X-ring, O-ring, HD and Standard options.

To compliment the chain, Bike It utilise JT sprockets to offer a comprehensive range of Chain & Sprocket kits. JT Sprockets are Japanese made from C45 steel (rear sprockets) and C45 steel/ SCM415 chromoly (front sprockets).

The listed chain and sprocket kits are comprised of the correct combination sprockets and chain type/ grade for the bikes as stipulated by the manufacturer. Use of alternative chain will render warranty claims void - use the detailed chain grade only!

Please note, if the correct length of chain is not available, Bike It will send an alternative longer length that needs to be cut to the correct size. If JT Sprockets are not available, Bike It will send an alternative of equivalent quality.

To order, select correct bike model, then choose chain grade required.



Model	Year	Front	Rear	Notes	Chain	Manufacturers Recommended Chain Grade	STD Chain Order Code	HD Chain Order Code	O-RING Chain Order Code	X-RING Chain Order Code
<b>* 513-15 = 566-15</b>										
<b>Aprilia</b>										
50RS	99-05	1120-12	23-47	#	420-122	STD	JTKARS5A			
50RS	06-11	1128-11	1133-53	#	420-132	O-RING			JTKARS5B	
50RX	06-11	1128-11	1131-53	#	420-132	O-RING			JTKARS5B	
50SX	06-11	1128-11	1131-53	#	420-132	O-RING			JTKARS5B	
125 RS Extrema	93-03	394-16	701-39	ALTERNATE GEARING	520-108	HD		JTKARS1A	JTKARS1G	
125 RS Extrema	93-03	394-17	701-41	#	520-108	HD		JTKARS1C	JTKARS1H	
125 RS Extrema	04-05	394-17	701-40	#	520-108	HD		JTKARS1D	JTKARS1J	
125 RS Replica	93-03	394-14	701-39	#	520-108	HD		JTKARS1B	JTKARS1K	
125 RS Replica	93-03	394-16	701-39	ALTERNATE GEARING	520-108	HD		JTKARS1E	JTKARS1L	
125 RS	06-11	394-17	703-40	#	520-110	O-RING			JTKARS1F	
125 Tuono	03-07	394-14	701-40	#	520-104	HD		JTKATU1A	JTKATU1B	
250 RS	95-04	436-14	28-42	#	520-110	O-RING			JTKARS2A	
1000 RSV Mille R, SL, SP	98-04	704-17	702-42	#	525-108	X-RING			JTKARSV10C	JTKARSV10A
1000 RSV Tuono	03-05	704-17	702-42	#	525-108	X-RING			JTKARSV10C	JTKARSV10A
1000 RSV Mille R	04-08	704-16	702-40	#	525-106	X-RING			JTKARSV10D	JTKARSV10B
1000 Tuono R Racing	06-10	704-16	702-40	#	525-106	X-RING			JTKATU10B	JTKATU10A
1000 RSV R	04-09	704-16	702-40	#	525-106	O-RING			JTKATU10B	
1000 RSV4 Factory	09-10	704-16	702-40	#	525-TBC	O-RING			JTKARSV4	
<b>BMW</b>										
F650 GS Dakar	01-05	402-16	5-47	#	520-116	O-RING			JTKBF65C	
F650 GS	99-07	402-16	5-47	#	520-116	O-RING			JTKBF65C	
F650 GS	08	704-17	6-41	#	525-116	O-RING			JTKBF65B	
F650 GS (FOR 10.5MM BOLTS)	09-12	704-17	3-41	#	525-116	O-RING			JTKBF6A	
F650 GSE	12	704-17	3-41	#	525-116	O-RING			JTKBF6A	
F800 GS	09-12	704-16	3-42	#	525-116	O-RING			JTKBF8A	
F800 R	09-12	405-20	3-47	#	525-120	O-RING			JTKBF8B	
S1000 RR	09-11	404-17	7-44	#	525-118	O-RING			JTKBS10A	
S1000 RR	12	404-17	7-45	#	525-118	O-RING			JTKBS10B	



# Chain & Sprocket Kits cont...

Model	Year	Front	Rear	Notes	Chain	Manufacturers Recommended Chain Grade	STD Chain		O-RING Chain		X-RING Chain	
							Order Code	Order Code	Order Code	Order Code	Order Code	Order Code
<b>Cagiva</b>												
125 Raptor	04-10	711-14	701-43	#	520-116	HD	JTKCRPT1A	JTKCRPT1A				
125 Mito Evolution	92-99	711-14	701-41	#	520-114	HD	JTKCMT1B	JTKCMT1C				
125 Mito Evolution	00-04	711-14	701-39	ALTERNATE GEARING	520-114	HD	JTKCMT1A	JTKCMT1D				
125 Mito Euro 2	04-08	711-14	701-43	#	520-116	HD	JTKCRPT1A					
125 Mito SP525	08-10	711-14	701-43	#	520-116	HD	JTKCRPT1A					
<b>Daelim</b>												
125 Roadwin	04-07	259-14	269-42	#	428-146	HD	JTKLR1A					
125 Roadwin FI	08-09	259-14	269-42	#	428-146	HD	JTKLR1A					
<b>Derbi</b>												
50 Senda SM X-treme	00-05	1127-14	1131-53	#	420-130	HD	JTKD5SENA					
50 Senda SM/R X-treme	06-11	1128-11	1131-53	#	420-130	HD	JTKD5SENB					
50 Senda SM X-race	04-05	1127-14	1131-53	#	420-130	HD	JTKD5SENA					
50 Senda SM/R X-race	06-10	1128-11	1131-53	#	420-130	HD	JTKD5SENB					
<b>Ducati</b>												
600 Monster	99-01	736-15	735-46	#	520-102	O-RING	JTKD6MONB					
620 / S Monster ie	02-03	736-15	735-46	#	520-106	O-RING	JTKD6MONA					
620 / S Monster ie	04-06	736-15	735-48	#	520-106	O-RING	JTKD6MONC					
620 Monster Dark	03	736-15	735-46	#	520-106	O-RING	JTKD6MONA					
620 Monster Dark	04-06	736-15	735-48	#	520-106	O-RING	JTKD6MONC					
695 Monster	07	736-15	735-48	#	520-106	O-RING	JTKD6MONC					
695 Monster	08	736-15	735-42	#	520-106	O-RING	JTKD6MOND					
696 Monster	08-11	736-15	735-45	#	520-106	O-RING	JTKD6MONE					
696 Monster	12	736-15	735-45	#	520-108	O-RING	JTKD6MONF					
749 S	03	740-14	744-39	#	525-96	X-RING	JTKD749E	JTKD749A				
749 S	04-06	741-14	744-38	#	525-96	X-RING	JTKD749F	JTKD749D				
749	04-05	740-14	744-39	#	525-96	X-RING	JTKD749E	JTKD749A				
749	06	740-14	744-39	#	525-98	X-RING	JTKD749G	JTKD749B				
749 R	06	741-15	744-36	#	525-98	X-RING	JTKD749H	JTKD749C				
750 Monster	98-01	736-15	735-41	#	520-100	O-RING	JTKD7MONA					
750 Monster ie / Dark	02	736-15	735-41	#	520-102	O-RING	JTKD7MONB					
800 Monster ie	03-04	736-15	735-42	#	520-102	O-RING	JTKD8MONA					
800 Monster Dark	03	736-15	735-42	#	520-102	O-RING	JTKD8MONA					
848	08-10	741-15	752-39 +	ALU REAR / JT750B REAR	525-98	O-RING	JTKD848B					
			JT750B	SPROCKET CARRIER								
848	08-09	740-15	752-40 +	ALU REAR / JT750B REAR	525-98	O-RING	JTKD848C					
			JT750B	SPROCKET CARRIER								
848 EVO	11-12	741-15	752-39 +	ALU REAR / JT750B REAR	525-TBC	O-RING	TBC					
			JT750B	SPROCKET CARRIER								
900 Monster	94-98	736-15	735-39	#	520-98	O-RING	JTKD9MONA					

\* 513-15 = 566-15



# Chain & Sprocket Kits cont...

Model	Year	Front	Rear	Notes	Chain	Manufacturers Recommended Chain Grade	STD Chain Order Code	HD Chain Order Code	O-RING Chain Order Code	X-RING Chain Order Code
<b>Ducati cont...</b>										
900 Monster ie	00-01	736-15	735-39	#	520-98	O-RING			JTKD9MONA	
900 Monster	99	736-15	735-38	#	520-98	O-RING			JTKD9MONB	
900 Monster ie	02	736-15	735-38	#	520-100	O-RING			JTKD9MONC	
916 Monster S4	01-03	740-15	745-37	#	525-100	O-RING			JTKD9MOND	
999 / S	03-06	740-15	744-36	#	525-96	X-RING			JTKD999B	JTKD999A
999 R	06	740-15	744-36	#	525-96	X-RING			JTKD999B	JTKD999A
1000 Monster ie	03-05	740-15	745-39	#	525-100	O-RING			JTKD10MONA	
1000 Monster S ie	04-05	740-15	745-39	#	525-100	O-RING			JTKD10MONA	
1098 / R / S	07-09	741-15	761-38 + JTA760B	ALU REAR / JT750B REAR SPROCKET CARRIER	525-98	O-RING			JTKD10A	
1099 Streetfighter / S	09-11	741-15	761-38 + JTA760B	ALU REAR / JT750B REAR SPROCKET CARRIER	525-102	O-RING			JTKD10SFA	
1100 / S Monster	09-10	741-15	752-39 + JT750B	ALU REAR / JT750B REAR SPROCKET CARRIER	525-104	O-RING			JTKD11MONA	
1100 / S Multistrada	07-09	741-15	752-42 + JT750B	ALU REAR / JT750B REAR SPROCKET CARRIER	525-106	O-RING			JTKD11MSTA	
1100 / S Hypermotard	08-09	741-15	752-42 + JT750B	ALU REAR / JT750B REAR SPROCKET CARRIER	525-104	O-RING			JTKD11HYPA	
1198 / S	09-11	741-15	761-38 + JTA760B	ALU REAR / JT760B REAR SPROCKET CARRIER	525-98	O-RING			JTKD11A	
<b>Honda</b>										
C90 CLUB	84-02	253-15	211-39	#	420-98	STD	JTKHC90			
ANF125 Innova	03-11	249-14	212-35	#	420-104	STD	JTKHANF125A			
CBR125 R-4,5,6,7,8,9,A	04-10	1264-15	1206-42	#	428-124	HD	JTKHCBR1A			
CBR125 R B-C	11-12	1264-15	1221-44	#	428-130	HD	JTKHCBR1B			
CBF125 M9-MB	09-11	1264-16	1219-42	#	428-118	HD	JTKHCBF1A			
CBF125 MC	12	1264-16	1219-42	#	428-118	HD	JTKHCBF1A			
CBZ125 EIRE	01	264-14	269-44	#	428-126	HD	JTKHCBZ1A			
CG125 Brazil	85-92	259-14	269-41	#	428-110	HD	JTKHCG125BA			
CG125 Brazil	93-98	259-14	269-41	#	428-114	HD	JTKHCG125BB			
CG125 E	98	259-15	269-36	#	428-112	HD	JTKHCG125E			
CG125	99-00	259-15	269-36	#	428-112	HD	JTKHCG125E			
CG125 W	01	259-15	269-36	#	428-112	HD	JTKHCG125E			
CG125 M1	02-05	259-14	269-43	#	428-116	HD	JTKHCG125F			
CG125	06>	259-14	218-44	ALTERNATE GEARING	428-116	HD	JTKHCG125A			
NSR125 R-R,S,V	93-98	327-14	604-36	#	520-108	HD	JTKHNSR1A			
NSR125 R-Y,1	99-02	327-14	604-38	#	520-110	HD	JTKHNSR1B			
VT125 C,C2 Shadow	99-07	327-14	279-41	#	520-112	HD	JTKHVT1A			JTKHXL1A
XL125 V Varadero	01-11	327-14	273-44	#	520-110	O-RING				
XLR125 W-2	98-02	1264-17	1249-51	#	428-130	HD	JTKHXLR1A			
XR125 L-3,4,5,6,7	03-07	1264-17	1258-54	#	428-132	HD	JTKHXLR1A			

\* 513-15 = 566-15

- MotorGP
- Exhausts
- Screens
- Commuter
- Controls
- Headlights
- Indicators
- Mirrors
- Rear Lights
- Lifts & Stands
- Tools
- Batteries & Chargers
- Electrics
- Chain
- Servicing
- Tires & Tubes
- Security
- Bike Accs
- Luggage
- Rider Accs
- Tank Pads
- Extras

# Chain & Sprocket Kits cont...

Model	Year	Front	Rear	Notes	Chain	Manufacturers Recommended Chain Grade	STD Chain		HD Chain		O-RING Chain		X-RING Chain	
							Order Code	Order Code	Order Code	Order Code	Order Code	Order Code	Order Code	Order Code
<b>Honda cont...</b>														
CB250 N Two Fifty	92-02	287-14	272-31	#	520-104	O-RING	JTKHCB2A					JTKHCB2A		
CB250 Night Hawk	99-08	287-14	279-33	#	520-106	O-RING	JTKHCBF25B					JTKHCBF25B		
CBF250	04-06	1321-13	254-37	#	520-106	O-RING	JTKHCBF25A					JTKHCBF25A		
CBR250 R	11-12	1321-14	1220-38	#	520-108	O-RING	JTKHCBR2A					JTKHCBR2A		
VFR400 R3-L,M (NC30)	90-93	297-15	312-40	#	525-108	O-RING	JTKHVFR4A					JTKHVFR4A		
CB500 R,S,T,V,W	94-03	297-15	1332-40	#	525-108	O-RING	JTKHCB5A					JTKHCB5A		
CB500 S-W,X,Y,1,2,3	98-03	297-15	1332-40	#	525-108	O-RING	JTKHCB5A					JTKHCB5A		
CBF500 / ABS	04-08	297-15	1304-41	#	525-110	O-RING	JTKHCBF50A					JTKHCBF50A		
CB600 S F2-Y,1,2,3 Hornet	00-03	1371-15	1304-42	#	525-110	X-RING	JTKHCB6C					JTKHCB6A		
CB600 Hornet F-W,X,Y,1,2,3,4,5,6	98-06	1371-15	1304-42	#	525-110	X-RING	JTKHCB6C					JTKHCB6A		
CB600 Hornet F	07-12	1370-16	1304-43	#	525-118	O-RING	JTKHCB6B					JTKHCB6A		
CBF600 S-4-7 ABS	04-07	1371-15	1304-43	#	525-116	O-RING	JTKHCBF6A					JTKHCB6A		
CBF600 N-4,5,6,7	04-07	1371-15	1304-43	#	525-116	O-RING	JTKHCBF6B					JTKHCB6A		
CBF600	08-12	1370-16	1304-42	#	525-124	O-RING	JTKHCBF6C					JTKHCB6A		
CBR600 FH,F,J,FK,FL	87-90	295-15	1334-43	#	530-110	O-RING	JTKHCBR6J					JTKHCB6A		
CBR600 FM,FN,FP,FR,FS,FT	91-96	295-15	302-43	#	530-108	X-RING	JTKHCBR6K					JTKHCB6A		
CBR600 FV,FW	97-98	1371-15	1304-43	#	525-110	X-RING	JTKHCBR6L					JTKHCB6A		
CBR600 FX,FY	99-00	1370-16	1304-44	#	525-108	X-RING	JTKHCBR6M					JTKHCB6A		
CBR600 F1	01	1370-16	1307-45	#	525-112	X-RING	JTKHCBR6N					JTKHCB6A		
CBR600 FS-1, FS-2 Sport	01-02	1370-16	1307-46	#	525-112	X-RING	JTKHCBR6O					JTKHCB6A		
CBR600 F2,F3,F4,F5,F6,F7	02-07	1370-16	1307-45	#	525-108	X-RING	JTKHCBR6P					JTKHCB6A		
CBR600 RR-3,4,5,6	03-06	1370-16	1307-42	#	525-112	X-RING	JTKHCBR6Q					JTKHCB6A		
CBR600 RR-7,8,9,A,B	07-11	1370-16	1307-41	#	525-112	X-RING	JTKHCBR6R					JTKHCB6A		
CBR600 C-ABS RA-B	10-12	1370-16	1307-41	#	525-112	X-RING	JTKHCBR6R					JTKHCB6A		
VT600 C Shadow (VLX)	99-07	296-16	1332-44	#	525-120	O-RING	JTKHVT6A					JTKHCB6A		
VT600 CD Shadow Deluxe	94-00	296-16	1332-44	#	525-120	O-RING	JTKHVT6A					JTKHCB6A		
VT600 CD/CD2 Shadow Deluxe	01-07	296-16	1332-44	#	525-120	O-RING	JTKHVT6A					JTKHCB6A		
FMX650	05-08	308-14	245/3-42	#	520-110	O-RING	JTKHFMX65A					JTKHCB6A		
XL600 Transalp	91-00	296-15	300-47	#	525-120	O-RING	JTKHXL6B					JTKHCB6A		
XL650 V Transalp	01-07	296-15	300-48	#	525-118	O-RING	JTKHXL6A					JTKHCB6A		
XR650 R Y-6	00-07	1307-14	210-48	ALU REAR	525-110	O-RING	JTKHXR6A					JTKHCB6A		
XL700 VVA Transalp 8,9,A	08-12	296-15	300-47	#	525-118	O-RING	JTKHXL7A					JTKHCB6A		
CB750 F2-N-Y	92-00	1332-15	1332-40	#	525-112	O-RING	JTKHCB7A					JTKHCB6A		
CB750 F2-1	01-03	1332-15	1332-40	#	525-112	O-RING	JTKHCB7A					JTKHCB6A		
VF750 C Magna	99-04	333-16	1334-40	#	530-118	O-RING	JTKHV75A					JTKHCB6A		
VF750 CD / 2 Magna Deluxe	95-04	333-16	1334-40	#	530-118	O-RING	JTKHV75A					JTKHCB6A		
VFR750 FL,FM,FN,FP,FR,FS,FT,FV,FW (RC36)	90-98	333-16	1340-43	#	530-112	X-RING	JTKHVFR7B					JTKHCB6A		
VT750 C / CD / C2 / CD2 Shadow / Deluxe	98-07	1372-17	1304-41	#	525-122	O-RING	JTKHVT7A					JTKHCB6A		
VT750 DC Shadow Spirit	01-07	1372-17	1304-42	#	525-122	O-RING	JTKHVT75B					JTKHCB6A		
XR750 Africa Twin	93-03	314-16	1332-45	#	525-124	O-RING	JTKHXR7A					JTKHCB6A		

\* 513-15 = 566-15



# Chain & Sprocket Kits cont...

Model	Year	Front	Rear	Notes	Chain	Manufacturers Recommended Chain Grade	STD Chain Order Code	HD Chain Order Code	O-RING Chain Order Code	X-RING Chain Order Code
<b>Honda cont...</b>										
VFR800 FI-W,X,Y,1 PGM/CBS	98-01	339-17	1340-43	#	530-108	X-RING			JTKHVFR8C	JTKHVFR8A
VFR800 Vtec / ABS	02-11	339-16	1340-43	#	530-110	X-RING			JTKHVFR8D	JTKHVFR8B
VFR800 X-C	12	339-16	1340-43	#	530-116	X-RING			JTKHVFR8F	JTKHVFR8E
CB900 F Hornet	02-06	333-16	302-43	#	530-114	X-RING			JTKHCB9B	JTKHCB9A
CBR900RR N,P,R,S Fireblade	92-95	333-16	302-42	#	530-108	X-RING			JTKHCBR9G	JTKHCBR9D
CBR900RR T,V,W,X Fireblade	96-99	1370-16	1304-42	#	525-108	X-RING			JTKHCBR9E	JTKHCBR9A
CBR900RR Y,1, 2, 3 Fireblade	00-03	333-16	1306-42	#	530-108	X-RING			JTKHCBR9F	JTKHCBR9C
CB1000 R/RA-8-C (ABS)	08-12	333-16	1340-44	#	530-116	O-RING			JTKHCB10A	
CBF1000 F-B, CC	11-12	333-16	302-41	#	530-114	O-RING			JTKHCB10B	
CBF1000 F / ABS	06-10	333-16	302-43	#	530-120	O-RING			JTKHCBF10A	
CBR1000 FT,FV,FW,FX,FY	96-00	339-17	1334-41	#	530-114	O-RING			JTKHCBR10C	
CBR1000 RR Fireblade	04-05	333-16	1306-40	#	530-114	O-RING			JTKHCBR10A	
CBR1000 RR Fireblade	06-07	333-16	1306-42	#	530-114	X-RING			JTKHCBR10E	JTKHCBR10B
CBR1000RR Fireblade	08-12	333-16	1306-42	#	530-116	O-RING			JTKHCBR10D	
VTR1000F-V,W,X,Y,1,2,3,4,5 Firestorm	97-05	333-16	302-41	#	530-102	X-RING			JTKHVTRD	JTKHVTRA
VTR1000 SP-1	00-01	333-16	1306-40	#	530-104	X-RING			JTKHVTRF	JTKHVTRB
VTR1000 SP-2	02-06	333-16	1306-40	#	530-106	X-RING			JTKHVTRG	
XL1000 V-C Varadero	99-12	1370-16	1304-47	#	525-112	X-RING			JTKHXL10B	JTKHXL10A
CB1100SF (X-11)	00-03	339-17	302-43	#	530-110	X-RING			JTKHCB11SG	JTKHCB11SF
CBR1100 XX-V,W,X,Y,1,2,3,4,5,6,7 Blackbird	97-07	339-17	302-44	#	530-110	X-RING			JTKHCBR11B	JTKHCBR11A
CB1300 F-3,4,5,6,7,8,9	03-09	339-18	302-39	#	530-114	O-RING			JTKHCB13A	
CB1300 S-6,7,8,9	06-09	339-18	302-39	#	530-114	O-RING			JTKHCB13A	
CB1300 SA-C	10-12	339-18	302-39	#	530-114	O-RING			JTKHCB13A	
<b>Hyosung</b>										
GV125 C / Aquila	01-10	410-14	810-48	ALTERNATE GEARING	428-138	HD		JTKHYGV1A		
GT125 Naked	03-08	410-14	1067-52	#	428-138	HD		JTKHYGT1A		
GT125R Comet	09-12	410-14	1067-52	#	428-138	HD		JTKHYGT1A		
GT125R Supersport	06-08	410-14	1067-52	#	428-138	HD		JTKHYGT1A		
RT125 Katyon D Citytrail	08-10	410-13	810-48	#	428-128	HD		JTKHYRT1A		
RX125 D	07-11	410-14	810-48	#	428-132	HD		JTKHYRX1A		
XR125 Funduro	07-08	410-14	810-48	#	428-132	HD		JTKHYRX1A		
GT250 R EFI	11-12	1554-14	1068-46	#	520-112	O-RING		JTKHYGT2A		
GT250 Sport R	04-08	1554-14	1068-46	#	520-112	O-RING		JTKHYGT2A		
GT250 Comet / FI	06-10	1554-14	1068-46	#	520-112	O-RING		JTKHYGT2A		
GT650 / R / S Comet / FI	04-10	520-15	1074-44	#	525-108	O-RING		JTKHYGT65A		
GT650 Naked	04-06	520-15	1074-44	#	525-108	O-RING		JTKHYGT65A		
GT650R Sport-Touring	05-08	520-15	1074-44	#	525-108	O-RING		JTKHYGT65A		
GT650S Sport	05-08	520-15	1074-44	#	525-108	O-RING		JTKHYGT65A		
GT650S EFI	11	520-15	1074-44	#	525-108	O-RING		JTKHYGT65A		

\* 513-15 = 566-15

- MotorGP
- Exhausts
- Screens
- Commuter
- Controls
- Headlights
- Indicators
- Mirrors
- Rear Lights
- Lifts & Stands
- Tools
- Batteries & Chargers
- Electrics
- Chain
- Servicing
- Tyres & Tubes
- Security
- Bike Accs
- Luggage
- Rider Accs
- Tank Pads
- Extras

# Chain & Sprocket Kits cont...

Model	Year	Front	Rear	Notes	Chain	Manufacturers Recommended Chain Grade		STD Chain Order Code		HD Chain Order Code		O-RING Chain Order Code		X-RING Chain Order Code	
						Chain Grade	Order Code	Chain	Order Code	Chain	Order Code	Chain	Order Code	Chain	Order Code
<b>Kawasaki</b>															
BN125 Eliminator A1-A9F	98-09	417-15	468-46	#	428-132	HD		JTKKBN125A							
KMX125 A1-5, B1-12	86-03	417-14	463-48	#	428-124	HD		JTKKKNM125A							
EX250R Ninja K8F-KCF	08-12	1539-14	486-43	#	520-106	O-RING		JTKKEX2B							
KLX250 SF W9F, WAF	09-10	516-13	460-39	#	520-104	O-RING		JTKKKLX25A							
KLX250 S TCF	12	516-14	460-42	#	520-106	O-RING		JTKKKLX25B							
ZXR400 H2, L1-L9	88-02	512-15	478-45	#	520-110	O-RING		JTKKZX4A							
EN500 Vulcan C1-C10	96-05	512-16	1490-42	#	520-110	O-RING		JTKKEN5A							
EN500 Vulcan C6F-C9F	06-09	512-16	1490-42	#	520-110	O-RING		JTKKEN5A							
ER-5 (ER500) A1-A4, C1-C4, Twister	97-06	512-17	486-42	#	520-106	O-RING		JTKKER5A							
GPZ500 S D1-12	94-05	512-16	486-41	#	520-104	O-RING		JTKKGPZ5A							
KLE500 B6F-B7F	06-07	512-17	487-44	#	520-110	O-RING		JTKKKL5A							
ER-6N A6F-CBF	06-12	565-15	478-46	#	520-114	O-RING		JTKKER6A							
ER-6F A6F-DAF	06-10	565-15	478-46	#	520-114	O-RING		JTKKER6A							
ZX6-R F1-F3 Ninja	95-97	1515-15	498-40	#	525-108	X-RING		JTKKZX6G							JTKKZX6C
ZX6-R G1-G2 Ninja	98-99	1535-15	1489-40	#	525-108	X-RING		JTKKZX6H							JTKKZX6B
ZX6-R J1-J2 Ninja	00-01	1535-15	1489-40	#	525-108	X-RING		JTKKZX6H							JTKKZX6B
ZX6-RA1P Ninja	02	1535-15	1489-40	#	525-108	X-RING		JTKKZX6H							JTKKZX6B
ZX-6R B1-B2 Ninja	03-04	1307-15	1478-40	#	520-108	X-RING		JTKKZX6I							JTKKZX6D
ZX-6RR K1, M1 Ninja	03-04	1307-15	1478-40	#	520-108	X-RING		JTKKZX6I							JTKKZX6D
ZX-6R C1, C6F, D6F Ninja	05-06	1307-15	1478-43	#	520-110	X-RING		JTKKZX6J							JTKKZX6E
ZX-6RR N1, N6F	05-06	1307-15	1478-43	#	520-110	X-RING		JTKKZX6J							JTKKZX6E
ZX-6R	07-12	1536-16	478-43	#	520-112	O-RING		JTKKZX6F							
ZZ-R600 (ZX600 E1-E12)	93-05	519-16	499-48	#	530-112	O-RING		JTKKZZR6A							
ZZ-R600	05-08	1535-15	1489-40	#	525-108	O-RING		JTKKZZR6B							
KLR650	90-11	511-15	487-43	#	520-106	O-RING		JTKKCLR6A							
KLE650 Versys A7F-CBF	07-11	565-15	478-46	#	520-114	O-RING		JTKK650A							
KLE650 Versys ABS B7F-DBF	07-11	565-15	478-46	#	520-114	O-RING		JTKK650A							
ZX-7RR N1-N2 Ninja	96-99	520-16	1489-42	#	525-108	X-RING		JTKKZX7C							JTKKZX7B
ZX-7R P1-P8 Ninja	96-03	520-16	1489-43	#	525-110	X-RING		JTKKZX7D							JTKKZX7A
Z750 J1-J6F, L7F-LBF, M7F-M9F (MAF-MBF ABS)	04-11	1538-15	1478-43	#	520-112	O-RING		JTKKZ75A							
Z750 S K1, K6F	05-06	1538-15	1478-43	#	520-112	O-RING		JTKKZ75A							
Z750 M ABS	07-09	1538-15	478-43	#	520-112	O-RING		JTKKZ75B							
ZR-7 F1-F5	99-04	520-16	498-38	#	525-108	O-RING		JTKKZR7A							
ZR-7S H1-H3	01-04	520-16	498-38	#	525-108	O-RING		JTKKZR7A							
ZXR750 R L1-L3	93-95	519-16	488-44	#	530-110	O-RING		JTKKZXR7A							
VN800 A3-A11 Vulcan	97-05	519-17	499-42	#	530-114	O-RING		JTKKVN8C							
VN800 B1-B10 Classic	96-06	519-17	499-42	#	530-112	O-RING		JTKKVN8A							
VN800 C1-E6F Drifter	99-06	519-17	499-40	#	530-112	O-RING		JTKKVN8B							
ZX-9R B1-B4 Ninja	94-97	519-16	488-44	#	530-112	X-RING		JTKKZX9D							JTKKZX9A
ZX-9R C1-C2, E1-E2 Ninja	98-01	519-16	488-41	#	530-110	X-RING		JTKKZX9E							JTKKZX9B

\* 513-15 = 566-15

**Kawasaki**



# Chain & Sprocket Kits cont...

Model	Year	Front	Rear	Notes	Chain	Manufacturers Recommended Chain Grade	STD Chain Order Code	HD Chain Order Code	O-RING Chain Order Code	X-RING Chain Order Code
<b>Kawasaki cont...</b>										
ZX-9R F1-F2 Ninja	02-03	1537-16	1489-41	#	525-110	X-RING			JTKKZX9F	JTKKZX9C
KLV1000	04-06	1537-17	1792-41	#	525-112	O-RING			JTKKLV10A	
Z1000 A1-A3,A6F	03-06	1537-16	1489-42	#	525-112	X-RING			JTKKZ10C	JTKKZ10A
Z1000 B7F-B9F	07-09	1537-15	1489-40	#	525-110	X-RING			JTKKZ10D	JTKKZ10B
Z1000 ABS DAF	10	1537-15	1489-42	#	525-112	O-RING			JTKKZ10F	
Z1000 SX GBF-GCF	11-12	1537-15	1489-41	#	525-112	O-RING			JTKKZ10G	
Z1000 SX HBF ABS	11	1537-15	1489-41	#	525-112	O-RING			JTKKZ10G	
Z1000 SX City	11	1537-15	1489-41	#	525-112	O-RING			JTKKZ10G	
Z1000 SX Tourer	11-12	1537-15	1489-41	#	525-112	O-RING			JTKKZ10G	
Z1000 DBF	11	1537-15	1489-42	#	525-112	O-RING			JTKKZ10F	
Z1000 Black E	10-12	1537-15	1489-42	#	525-112	O-RING			JTKKZ10F	
ZX-10R C1-C2 Ninja	04-05	1537-17	1489-39	#	525-110	X-RING			JTKKZX10D	JTKKZX10A
ZX-10R D6F-D7F Ninja	06-07	1537-17	1489-40	#	525-108	X-RING			JTKKZX10E	JTKKZX10B
ZX-10R E8F-FAF Ninja	08-10	1537-17	1489-41	#	525-110	O-RING			JTKKZX10C	
ZX-10R JBF Ninja	11>	1537-17	1489-39	#	525-112	O-RING			JTKKZX10F	
ZX-10R KBF Ninja ABS	11>	1537-17	1489-39	#	525-112	O-RING			JTKKZX10F	
ZRX1100 C1-C4,D1	97-00	1529-17	502-45	#	530-110	X-RING			JTKKZRX11B	JTKKZRX11A
ZZ-R1100 D1-D5, D8-D9	93-97	517-17	502-45	#	530-110	X-RING			JTKKZZR11C	JTKKZZR11B
ZZ-R1100 D6-D7	98-99	517-17	502-44	#	530-110	X-RING			JTKKZZR11D	JTKKZZR11A
ZZ-R1100 D8-D9	00-01	517-17	502-45	#	530-110	X-RING			JTKKZZR11C	JTKKZZR11B
ZRX1200	01-04	1529-17	488-42	#	530-110	X-RING			JTKKZRX12B	JTKKZRX12A
ZRX1200 RA1-A5	01-06	1529-17	488-42	#	530-110	X-RING			JTKKZRX12B	JTKKZRX12A
ZRX1200 S B1P-B3P	01-06	1529-17	488-42	#	530-110	X-RING			JTKKZRX12B	JTKKZRX12A
ZX-12R A1-A2	00-01	517-18	488-46	#	530-116	X-RING			JTKKZX12B	JTKKZX12A
ZX-12R B1-B4	02-05	517-18	488-46	#	530-116	X-RING			JTKKZX12B	JTKKZX12A
ZZ-R1200 C1-C4	02-05	517-17	488-44	#	530-112	X-RING			JTKKZZR12B	JTKKZZR12A
ZX-14 A Ninja	06-08	517-17	1493-41	#	530-116	X-RING			JTKKZX14B	JTKKZX14A
ZX-14 C Ninja	09-11	517-17	1493-41	#	530-116	X-RING			JTKKZX14B	JTKKZX14A
ZX-14 C Ninja ECF	12	517-17	1493-42	#	530-116	X-RING			JTKKZX14C	
ZZR1400 B/D	06-10	517-17	1493-41	#	530-116	X-RING			JTKKZX14B	
<b>KTMM</b>										
125 Duke	11-12	1903-14	273-45	#	525-112	HD		JTKVDK1A		
<b>Rieju</b>										
50 Naked	04-09	1120-11	1077-47	#	420-126	STD	JTKRRS5A			
125 RS2 Matrix	06-09	1263-14	1081-46	#	428-126	HD		JTKRRS1A		
125 RS2 Naked	06-09	1263-14	1081-46	#	428-126	HD		JTKRRS1A		

\* 513-15 = 566-15

- Motorcycle
- Exhausts
- Screens
- Commuter
- Controls
- Headlights
- Indicators
- Mirrors
- Rear Lights
- Lifts & Stands
- Tools
- Batteries & Chargers
- Electrics
- Chain
- Servicing
- Tyres & Tubes
- Security
- Bike Accs
- Luggage
- Rider Accs
- Tank Pads
- Extras

# Chain & Sprocket Kits cont...

Model	Year	Front	Rear	Notes	Chain	Manufacturers Recommended Chain Grade	STD		O-RING		X-RING	
							Chain	Order Code	Chain	Order Code	Chain	Order Code
<b>Suzuki</b>												
DR-Z125 K3-K9, L0	03-10	409-14	797-51	#	428-134	HD	JTKSDRZ1A					
DR-Z125 L K3-K9, L0	03-10	409-14	797-57	#	428-134	HD	JTKSDRZ1B					
FL125 SDW Address	07-10	273-14	802-34	#	428-100	HD	JTKSFL1A					
GZ125 Marauder	98-10	410-15	1794-45	#	428-132	HD	JTKSGZ125A					
RV125 K3-K6 Van Van	03-06	425-15	1796-51	#	428-134	HD	JTKSRV1A					
RV125 K7-L0 Van Van	07-10	425-15	1796-49	#	428-134	HD	JTKSRV1B					
VL125 Intruder LC	00-07	410-14	1806-56	#	428-142	HD	JTKSVL1A					
DR-Z250 K1-K7	01-07	432-13	808-49	ALU REAR	520-112	O-RING	JTKSDRZ25A					
DR-Z400S K1-L2	00-12	432-15	808-44	#	520-112	O-RING	JTKSDRZ4A					
DR-Z400 E K1-K7	01-07	432-14	808-47	#	520-112	O-RING	JTKSDRZ4B					
DR-Z400 SM 05-L0	05-10	432-15	808-41	#	520-112	O-RING	JTKSDRZ4C					
GS500 E-R,S,T,V,W (2 cyl)	94-98	516-16	823-39	#	520-112	O-RING	JTKSGS5A					
GS500 E-Y,K1-K7	99-07	516-16	823-39	#	520-110	O-RING	JTKSGS5B					
GS500F K4-L0	04-10	516-16	823-39	#	520-110	O-RING	JTKSGS5B					
GSF 600 / S Bandit	95-99	566-15*	829-47	#	530-110	X-RING	JTKSGSF6A					
GSF 600 / S Bandit	00-04	566-15*	829-47	#	530-112	X-RING	JTKSGSF6D					
GSR600 K6-L0	06-10	520-16	1792-48	#	525-114	X-RING	JTKSGSR6B					
GSR600 B Yoshimura	10	520-16	1792-48	#	525-114	O-RING	JTKSGSR6B					
GSX600 F-W,X,Y,K1-K6	98-06	566-15*	829-47	#	530-118	O-RING	JTKSGSX6A					
GSX-R600 V,W,X	97-99	520-16	498-45	#	525-108	X-RING	JTKSGSXR6E					
GSX-R600 Y	00	520-16	498-46	#	525-108	X-RING	JTKSGSXR6C					
GSX-R600 K1-K5	01-05	520-16	1792-45	#	525-110	X-RING	JTKSGSXR6G					
GSX-R600 K6-L0	06-10	520-16	1792-43	#	525-114	O-RING	JTKSGSXR6D					
GSX-R600 L1-L2	11-12	520-16	1876-43	#	525-114	O-RING	JTKSGSXR6H					
DL650 V-Strom K4-K9	04-09	520-15	1792-47	#	525-116	O-RING	JTKSDL65A					
DL650 V-Strom L0-L1	10-11	520-15	1792-47	#	525-118	O-RING	JTKSDL65B					
DL650 V-Strom ABS K7-L2	07-12	520-15	1792-47	#	525-118	O-RING	JTKSDL65B					
DL650 V-Strom G T A L0	10	520-15	1792-47	#	525-118	O-RING	JTKSDL65B					
DL650 V-Strom Traveller A L0	10	520-15	1792-47	#	525-118	O-RING	JTKSDL65B					
DL650 V-Strom X A L0-L1	10-11	520-15	1792-47	#	525-118	O-RING	JTKSDL65B					
GSF650 Bandit K5-K6	05-06	566-15*	829-47	#	530-112	O-RING	JTKSGSF65A					
GSF650 Bandit S-K5-K6	05-06	566-15*	829-47	#	530-116	O-RING	JTKSGSF65B					
GSF650 Bandit SA-K6	06	566-15*	829-47	#	530-116	O-RING	JTKSGSF65B					
GSF650 Bandit / SA K7-L2	07-12	520-15	807-48	#	525-118	O-RING	JTKSGSF65C					
GSF650 Bandit Traveller S-L0	10	520-15	807-48	#	525-118	O-RING	JTKSGSF65C					
GSX650 F K8-L1	08-11	520-15	807-48	#	525-118	O-RING	JTKSGSX65A					
SV650 X,Y,K1-K8	99-08	520-15	807-45	#	525-110	O-RING	JTKSSV6A					
SV650S X-K9	99-09	520-15	807-44	#	525-108	O-RING	JTKSSV6B					
SV650S L0-L2	10-12	520-15	807-45	#	525-108	O-RING	JTKSSV6D					

\* 513-15 = 566-15

Motocp  
Exhausts  
Screens  
Commuter  
Controls  
Headlights  
Indicators  
Mirrors  
Rear Lights  
Lifts & Stands  
Tools  
Batteries & Chargers  
Electrics  
Chain  
Servicing  
Tyres & Tubes  
Security  
Bike Accs  
Luggage  
Rider Accs  
Tank Pads  
Extras



# Chain & Sprocket Kits cont...

Model	Year	Front	Rear	Notes	Chain	Manufacturers Recommended Chain Grade	STD Chain Order Code	HD Chain Order Code	O-RING Chain Order Code	X-RING Chain Order Code
<b>Suzuki cont...</b>										
SV650 SA K8-L0 (ABS)	08-10	520-15	807-45	#	525-114	O-RING			JTKSSV6C	
SFV650 Gladius	09-11	565-15	823-46	#	520-112	O-RING			JTKSSFV6A	
GSX750 F-X, Y, K1-K6	99-06	566-15*	829-45	#	530-116	O-RING			JTKSGSX75A	
GSX-R750 WN, WP, WR, WS	92-95	566-15*	816-42	#	530-108	X-RING			JTKSGSX7G	JTKSGSX7A
GSX-R750 WT, WV, SRAD	96-97	566-15*	499-43	#	530-108	X-RING			JTKSGSX7H	JTKSGSX7B
GSX-R750 WW, SRAD, X Fuel Inj	98-99	520-16	498-44	#	525-110	X-RING			JTKSGSX7J	JTKSGSX7C
GSX-R750 Y, K1-K3 Fuel Inj, SRAD	00-03	520-17	1792-42	#	525-110	X-RING			JTKSGSX7K	JTKSGSX7D
GSX-R750 K4, K5 Fuel Injection	04-05	520-17	1792-43	#	525-110	X-RING			JTKSGSX7L	JTKSGSX7F
GSX-R750 K6-L0	06-10	520-17	1792-45	#	525-116	O-RING			JTKSGSX7E	
GSX-R750 L1-L2	11-12	520-16	1876-45	#	525-116	O-RING			JTKSGSX7M	
VZ800 Marauder V-K4	97-04	566-15*	829-48	#	530-116	O-RING			JTKSVZ8A	
DL1000 V-Strom K2-L0	02-10	520-17	1792-42	#	525-112	X-RING			JTKSDL10B	JTKSDL10A
DL1000 V-Strom SE L0	10	520-17	1792-42	#	525-112	O-RING			JTKSDL10B	
GSX-R1000 K1-K6	01-06	513-17	1800-42	#	530-110	X-RING			JTKSGSX1D	JTKSGSX1A
GSX-R1000 K7-K8	07-08	513-17	1800-43	#	530-112	X-RING			JTKSGSX1E	JTKSGSX1B
GSX-R1000 K9, L2	09-12	423-17	479-42	#	530-114	O-RING			JTKSGSX1C	
SV1000 K3-K7	03-07	513-17	1800-40	#	530-110	X-RING			JTKSSV1C	JTKSSV1A
SV1000S K3-K7	03-07	513-17	1800-40	#	530-108	X-RING			JTKSSV1D	JTKSSV1B
TL1000 R-W, X, Y, K1, K2	98-02	513-17	499-39	#	530-104	X-RING			JTKSTL1C	JTKSTL1A
TL1000 S-V, W, X, Y	97-00	513-17	499-38	#	530-104	X-RING			JTKSTL1D	JTKSTL1B
GSX-R1100 WP, WR	93-94	566-15*	816-42	530 CONVERSION	530-114	X-RING			JTKSGSX11C	JTKSGSX11A
GSX-R1100 WS, WT, WV, WW	95-98	513-16	816-44	530 CONVERSION	530-116	X-RING			JTKSGSX11D	JTKSGSX11B
GSF1200 Bandit / S T-K5	95-05	566-15*	816-45	530 CONVERSION	530-110	X-RING			JTKSGSF12F	JTKSGSF12A
GSF1200 Bandit SA-K6	06	566-15*	1800-45	#	530-116	X-RING			JTKSGSF12G	JTKSGSF12E
GSF1250 Bandit/S K7-K9 (ABS)	07-09	513-18	1800-43	#	530-118	X-RING			JTKSGSF12H	JTKSGSF12C
GSF1250 A-L0-L1 Bandit (ABS)	10-11	513-18	1800-43	#	530-120	O-RING			JTKSGSF12J	
GSF1250 SA Bandit Traveller L0	10	513-18	1800-43	#	530-120	O-RING			JTKSGSF12J	
GSX1250 F/FA Traveller L0	10	513-18	1800-43	#	530-120	O-RING			JTKSGSX12A	
Suzuki GSX1250 FA-L1	11	513-18	1800-43	#	530-120	O-RING			JTKSGSF12J	
Suzuki GSX1250 FA-L1 ST	11	513-18	1800-43	#	530-120	O-RING			JTKSGSF12J	
GSX-R1300R Hayabusa X-K5, RZ K3-K7	99-07	513-17	499-40	530 CONVERSION	530-112	X-RING			JTKSGSX13D	JTKSGSX13A
GSX-R1300R Hayabusa K8-L2	08-12	423-18	1800-43	#	530-118	O-RING			JTKSGSX13B	
GSX1300 B-King K8-L0	08-10	423-18	1800-43	#	530-118	O-RING			JTKSGSX13B	
GSX1400 K1-K8	01-08	513-18	1797-41	#	530-116	X-RING			JTKSGSX14B	JTKSGSX14A
<b>Triumph</b>										
600 Speed Four	03-05	1182-14	1792-42	#	525-106	O-RING			JTKTSPE6A	
600 Daytona	03-04	1182-14	1792-45	#	525-108	O-RING			JTKTDAY65A	
600 TT	00-03	1182-14	1792-42	#	525-106	O-RING			JTKTSPE6A	

\* 513-15 = 566-15

- MotorGP
- Exhausts
- Screens
- Commuter
- Controls
- Headlights
- Indicators
- Mirrors
- Rear Lights
- Lifts & Stands
- Tools
- Batteries & Chargers
- Electrics
- Chain
- Servicing
- Tyres & Tubes
- Security
- Bike Accs
- Luggage
- Rider Accs
- Tank Pads
- Extras

# Chain & Sprocket Kits cont...

Model	Year	Front	Rear	Notes	Chain	Manufacturers Recommended Chain Grade	STD Chain Order Code	HD Chain Order Code	O-RING Chain Order Code	X-RING Chain Order Code
<b>Triumph cont...</b>										
650 Daytona	05	1182-14	1792-45	#	525-108	O-RING	JTKTDAY65A		JTKTDAY65A	
675 Daytona	06-12	520-16	2014-47	#	525-116	O-RING	JTKTDAY67A		JTKTDAY67A	
675 Speed Triple / R	08-10	520-16	2014-47	#	525-116	O-RING	JTKTDAY67A		JTKTDAY67A	
800 Bonneville	02-06	1183-17	1792-43	#	525-104	O-RING	JTKTBON8B		JTKTBON8B	
800 Bonneville T100	03-05	1183-17	1792-43	#	525-104	O-RING	JTKTBON8B		JTKTBON8B	
800 Tiger XC	11	520-16	2014-50	#	525-124	O-RING	JTKTTIG8A		JTKTTIG8A	
865 Bonneville	07-12	1183-18	1792-43	#	525-104	O-RING	JTKTBON8A		JTKTBON8A	
865 Thruxton	07-11	1183-18	1792-43	#	525-104	O-RING	JTKTBON8A		JTKTBON8A	
865 Bonneville / Black / T100	07-12	1183-18	1792-43	#	525-104	O-RING	JTKTBON8A		JTKTBON8A	
865 Scrambler	07-11	1183-18	1792-43	#	525-106	O-RING	JTKTSCR8A		JTKTSCR8A	
955i Daytona	99-01	1180-18	2011-42	#	530-106	O-RING	JTKTDAY95B		JTKTDAY95B	
955i Daytona	03-06	1180-18	2011-42	#	530-106	O-RING	JTKTDAY95A		JTKTDAY95A	
955 Sprint ST	99-04	1180-18	2011-43	#	530-108	O-RING	JTKTSPR95A		JTKTSPR95A	
955 Sprint RS	00-03	1180-19	1800-43	#	530-108	O-RING	JTKTSPR95B		JTKTSPR95B	
1050 Sprint ST	05-11	1180-19	2011-42	#	530-106	O-RING	JTKTSPR10A		JTKTSPR10A	
1050 Speed Triple	05-12	1180-18	2011-42	#	530-106	O-RING	JTKTDAY95B		JTKTDAY95B	
1050 Tiger / SE	09-12	1180-18	1800-44	#	530-114	O-RING	JTKTTIG10A		JTKTTIG10A	
<b>Yamaha</b>										
DT125X	05-06	558-16	839-57	#	428-134	HD	JTKYDTR1A		JTKYDTR1A	
DTR125 (DT125R)	90-03	558-16	839-57	#	428-134	HD	JTKYDTR1A		JTKYDTR1A	
DT125 RE	04-06	558-16	839-57	#	428-134	HD	JTKYDTR1A		JTKYDTR1A	
SR125	95-03	1263-14	835-49	#	428-120	HD	JTKYSR1A		JTKYSR1A	
WR125 R/X -Y,A	09-11	1550-14	839-53	#	428-134	HD	JTKYWR1A		JTKYWR1A	
XT125 X	05-09	1263-14	1134-48	#	428-126	HD	JTKYXT1A		JTKYXT1A	
XT125 R	05-09	1263-14	1134-50	#	428-128	HD	JTKYXT1B		JTKYXT1B	
XVS125 Drag Star	00-04	564-13	857-47	520 CONVERSION	520-116	HD	JTKYXVS1A		JTKYXVS1A	
YBR125	05-06	1263-14	838-45	#	428-118	HD	JTKYYBR1A		JTKYYBR1A	
YBR125	07-12	548-14	838-45	#	428-118	HD	JTKYYBR1B		JTKYYBR1B	
YBR125 Custom	08-12	548-14	838-43	#	428-118	HD	JTKYYBR1C		JTKYYBR1C	
YZF125R	08-12	1550-14	1844-48	#	428-132	HD	JTKYYZF125A		JTKYYZF125A	
TW200 B1 10DM	12	1559-14	1842-50	#	428-122	HD	JTKYTW2A		JTKYTW2A	
WR250 R X-B	08-12	1590-13	245/2.43	#	520-108	HD	JTKYWR250C		JTKYWR250C	
WR250 X-A	08-11	1590-13	245/2.42	#	520-108	HD	JTKYWR250D		JTKYWR250D	
XT250 X-B	08-12	1594-15	1847-48	#	428-128	HD	JTKYXT2A		JTKYXT2A	
YBR250	07-10	1594-15	1870-44	#	428-132	HD	JTKYYBR2A		JTKYYBR2A	
FZ6	04-09	580-16	479-46	#	530-118	O-RING	JTKYFZ6A		JTKYFZ6A	
FZ6 Fazer	04-08	580-16	479-46	#	530-118	O-RING	JTKYFZ6A		JTKYFZ6A	
FZ6 Fazer S2 / ABS	07-09	580-16	479-46	#	530-118	O-RING	JTKYFZ6A		JTKYFZ6A	
FZS600 Fazer / SP Fazer	98-03	566-15*	859-48	#	530-110	X-RING	JTKYFZS6B		JTKYFZS6B	JTKYFZS6A
XJ600S D-R Diversion	92-03	582-16	855-48	#	520-110	X-RING	JTKYXJ6D		JTKYXJ6D	JTKYXJ6A

\* 513-15 = 566-15



# Chain & Sprocket Kits cont...

Model	Year	Front	Rear	Notes	Chain	Manufacturers Recommended Chain Grade	STD Chain Order Code	HD Chain Order Code	O-RING Chain Order Code	X-RING Chain Order Code
<b>Yamaha cont...</b>										
XJ600N	95-03	582-16	855-48	#	520-110	X-RING			JTKYXJ6E	JTKYXJ6B
XJ600 H, N	84-90	571-16	862-44	#	530-106	X-RING			JTKYXJ6F	JTKYXJ6C
XJ6 Diversion / ABS	09-12	1595-16	245/3-46	#	520-118	O-RING			JTKYXJ6G	
XJ600 XJ6 / ABS	09-11	1595-16	245/3-46	#	520-118	O-RING			JTKYXJ6G	
YZF R-6	99-02	580-16	1871-48	530 CONVERSION	530-116	X-RING			JTKYR6E	JTKYR6A
YZF R-6	03-05	580-16	479-48	530 CONVERSION	530-116	X-RING			JTKYR6F	JTKYR6B
YZF R-6	06-12	1586-16	1876-45	#	525-114	X-RING			JTKYR6G	JTKYR6C
YZF R-6	06-10	580-16	479-48	530 CONVERSION	530-114	X-RING			JTKYR6H	JTKYR6D
YZF R-6 S	06-10	580-16	479-48	530 CONVERSION	530-116	X-RING			JTKYR6F	JTKYR6B
YZF600R Thundercat	96-04	566-15*	859-47	#	530-108	X-RING			JTKYYZF6B	JTKYYZF6A
XT660 R	04-12	308-15	855-45	#	520-110	O-RING			JTKYXTZ6A	
XT660 X Super Motard	04-12	308-15	855-45	#	520-110	O-RING			JTKYXTZ6A	
XTZ660 Z Tenere	08-12	308-15	855-45	#	520-110	O-RING			JTKYXTZ6A	
MT-03	06-10	308-15	855-47	#	520-112	O-RING			JTKYMT03A	
YZF750 R	93-97	580-16	859-43	530 CONVERSION	530-106	X-RING			JTKYYZF7C	JTKYYZF7A
YZF750 SP	93-97	580-16	859-39	530 CONVERSION	530-104	X-RING			JTKYYZF7D	JTKYYZF7B
FZ8 N	10-12	1591-16	300-46	#	525-122	O-RING			JTKYFZ8A	
FZ8 S/SA Fazer 8 / ABS	10-12	1591-16	300-46	#	525-122	O-RING			JTKYFZ8A	
TDM850	99-01	520-16	867-43	#	525-114	O-RING			JTKYTDIM8A	
TDM900	02-12	1591-16	300-42	#	525-118	O-RING			JTKYTDIM9A	
FZR1000R Exup	89-95	580-17	859-47	530 CONVERSION	530-110	X-RING			JTKYFZR1C	JTKYFZR1A
FZS1000 Fazer	01-05	579-16	479-44	#	530-116	X-RING			JTKYFZS1B	JTKYFZS1A
FZ1 / Fazer ABS	06-12	579-17	479-45	#	530-122	X-RING			JTKYFZ1B	JTKYFZ1A
GTS1000	93-00	580-17	859-47	530 CONVERSION	530-118	X-RING			JTKYGTS1B	JTKYGTS1A
YZF R1	98-03	579-16	479-43	#	530-114	X-RING			JTKYR1E	JTKYR1A
YZF R1	04-05	579-17	479-45	#	530-116	X-RING			JTKYR1F	JTKYR1B
YZF R1 / SP	06-08	579-17	479-45	#	530-118	X-RING			JTKYR1G	JTKYR1C
YZF R1	09-12	579-17	1479-47	#	530-120	O-RING			JTKYR1D	
YZF1000R Thunderace	96-03	580-17	859-46	530 CONVERSION	530-110	X-RING			JTKYYZF1B	JTKYYZF1A
MT01	05-11	579-17	479-39	#	530-114	X-RING			JTKYMT01B	JTKYMT01A
FJ1200 / FJ1200A	91-96	579-17	859-39	#	530-110	X-RING			JTKYFJ12B	JTKYFJ12A
XJR1200	95-98	579-17	859-38	530 CONVERSION	530-110	X-RING			JTKYXJR12B	JTKYXJR12A
XJR1300 / SP	99-01	579-17	859-38	#	530-110	X-RING			JTKYXJR13E	JTKYXJR13A
XJR1300	02-03	579-17	859-39	#	530-112	X-RING			JTKYXJR13F	JTKYXJR13B
XJR1300	04-06	579-17	479-39	#	530-112	X-RING			JTKYXJR13G	JTKYXJR13C
XJR1300	07-12	579-17	479-38	#	530-110	O-RING			JTKYXJR13J	

\* 513-15 = 566-15



- MotorGP
- Exhausts
- Screens
- Commuter
- Controls
- Headlights
- Indicators
- Mirrors
- Rear Lights
- Lifts & Stands
- Tools
- Batteries & Chargers
- Electrics
- Chain
- Servicing
- Tyres & Tubes
- Security
- Bike Accs
- Luggage
- Rider Accs
- Tank Pads
- Extras



# ARMSTRONG

## RACING DISC PADS

Armstrong Racing Disc Pads offer a comprehensive range of TUV approved disc pads for all of today's motorcycle applications, on and off-road.

- **HH Gold Pads** – designed for use on all bikes, especially today's powerful superbikes. A sintered compound with heat transfer of up to 650°C, ideal for rapid braking.

- **GG Green Pads** – an organic compound pad particularly suited for commuters. A heat transfer of up to 350°C offers performance braking for lesser powered machines including scooters, learner-legals and mid-range power bikes.

- **HH MX Pads** – developed for the varied and demanding conditions of off-road riding, a sintered compound with excellent durability and resistance. As used by the Bike It Cosworth Yamaha Racing MX team in FIM World MX Championship.

- **C-Pro Race Pads** – a soft-sintered compound with added carbon component, offering a very high resistance to temperature with greater friction coefficient than standard sintered pads. Suited for harder sportsbike braking and track use.



**Manufactured from premium Japanese induction hardened stainless steel.**

### ARMSTRONG BRAKE DISCS

Armstrong Brake Discs comprises a fully comprehensive range of wavy design upgrades to OEM discs, offering improved braking. Braking performance is optimised by the wavy design by creating a more efficient area of disc pad contact.

All discs are precision laser cut from premium Japanese induction hardened stainless steel, diamond ground for perfect finish.

- Front floating wavy street discs
- Rear solid wavy street discs
- Front and Rear solid wavy off-road discs. As used by the Bike It Cosworth Yamaha Racing MX team in FIM World MX Championship.
- Oversize front floating wavy off-road discs, with caliper adaptor





# Armstrong Racing Disc Pads



To order Armstrong disc pads, select the required pads from the table below. Where there is a choice of compounds be sure to choose the one with the right properties for that motorcycle. See the splash page for advice about organic GG, sintered HH and sintered carbon C-PRO pads. Also visit [www.bikeit.co.uk](http://www.bikeit.co.uk) for full downloadable application list.

Cross Reference Guide			Armstrong	Armstrong	Armstrong
VESRAH	FERODO	EBC	GG Range	HH Range	C-PRO Range
VD907	FDB148	FA18	PAD230008	PAD320008	
VD107/112		FA29	PAD230019		
VD112	FDB182	FA30	PAD230020	PAD320020	
VD112	FDB182	FA31	PAD230020	PAD320020	
VD404/408/409/411	FDB132	FA33	PAD230023		
VD205/212	FDB177R	FA34	PAD230024		
VD306	FDB151R	FA36	PAD230026		
VD117	FDB183	FA45	PAD230035		
VD314		FA46	PAD230036		
VD911	FDB705	FA47	PAD230037	PAD320037	
VD912	FDB218	FA51	PAD230041	PAD320041	
VD120	FDB250	FA54	PAD230044	PAD320044	
VD-327/2		FA58	PAD230151	PAD320151	PAD440151
VD920	FDB694	FA60	PAD230050	PAD320050	
VD327	FDB338/R	FA63	PAD230053	PAD320053	PAD440053
VD324	FDB217	FA65	PAD230055	PAD320055	
VD420	FDB298/R	FA66	PAD230058	PAD320058	
VD325	FDB314	FA67	PAD230057	PAD320057	
VD420	FDB298/R	FA68	PAD230058	PAD320058	
VD123	FDB244/R	FA69	PAD230059	PAD320059	
VD123	FDB244/R	FA69/2	PAD232059		
VD123	FDB244/R	FA69/3	PAD233059	PAD323059	
VD228	FDB227	FA70	PAD230060		
VD235	FDB311	FA81	PAD230071	PAD320071	
VD339	FDB313	FA83	PAD230073	PAD320073	
VD128	FDB381	FA84	PAD230074	PAD320074	
VD127	FDB661	FA84/3		PAD323074	
VD424	FDB339/R	FA85	PAD230075	PAD320075	
VD131	FDB312	FA86	PAD230076	PAD320076	
VD236	FDB337/R	FA88	PAD230078	PAD320078	
VD134	FDB382	FA92	PAD230082	PAD320082	
VD346	FDB384	FA93	PAD230083		
VD919		FA94		PAD320084	
VD945	FR408	FA95	PAD230085	PAD320085	
VD932	FDB436	FA99	PAD230089	PAD320089	
		FA100	PAD230090		
VD239	FDB383	FA101	PAD230091	PAD320091	
VD330	FDB389/R	FA103	PAD230093	PAD320093	
VD240	FDB386/R	FA104	PAD230094	PAD320094	
VD329	FDB404	FA106	PAD230096	PAD320096	
VD329	FDB404	FA106/2		PAD322096	
VD335	FDB437	FA110	PAD230100		
VD152	FDB438	FA113	PAD230103		
VD-925	FDB405	FA115	PAD230105		
VD-937	FDB697	FA116	PAD230106	PAD320106	
VD-245	FDB583	FA118		PAD320108	
VD-244	FDB453	FA119		PAD320109	
VD-924	FDB592	FA120		PAD320110	
VD-142	FDB462	FA121	PAD230111	PAD320111	
VD-146		FA122	PAD230112	PAD320112	
VD-242	FDB662	FA123	PAD230113	PAD320113	
VD-143	FDB452/R	FA124	PAD230114	PAD320114	
VD-143/2	FDB663	FA124/2	PAD232114	PAD322114	
VD-139	FDB495	FA125	PAD230115	PAD320115	
VD-943	FDB498	FA126	PAD230116	PAD320116	
VD-427	FDB481/R	FA129	PAD230119	PAD320119	

\* Use of other brands codes for reference use only

\*\* Contains 4 pads.

Motocp  
Exhausts  
Screens  
Commuter  
Controls  
Headlights  
Indicators  
Mirrors  
Rear Lights  
Lifts & Stands  
Tools  
Batteries & Chargers  
Electrics  
Chain  
Servicing  
Tyres & Tubes  
Security  
Bike Accs  
Luggage  
Rider Accs  
Tank Pads  
Extras  
[www.bikeit.co.uk](http://www.bikeit.co.uk)

# Armstrong Racing Disc Pads

To order Armstrong disc pads, select the required pads from the table below. Where there is a choice of compounds be sure to choose the one with the right properties for that motorcycle. See the splash page for advice about organic GG, sintered HH and sintered carbon C-PRO pads. Also visit [www.bikeit.co.uk](http://www.bikeit.co.uk) for full downloadable application list.

Cross Reference Guide			Armstrong	Armstrong	Armstrong
VESRAH	FERODO	EBC	GG Range	HH Range	C-PRO Range
VD-144	FDB539	FA131	PAD230121	PAD320121	
VD-144	FDB783	FA131/2	PAD232121		
VD-144	FDB539	FA131/3	PAD233121		
VD-936	FDB561	FA132		PAD320122	
VD-340	FDB497	FA135	PAD230125	PAD320125	
VD-246	FDB591	FA136	PAD230126		
VD-341	FDB2016	FA137		PAD320127	
VD-923	FDB521	FA139		PAD320129	
VD-147	FDB531	FA140	PAD230130	PAD320130	
VD-430	FDB508	FA141	PAD230131	PAD320131	
VD-156	FDB570	FA142	PAD230132	PAD320132	
VD-156/2	FDB664	FA142/2	PAD232132	PAD322132	
VD-139/2	FDB496	FA143	PAD230133		
VD-154	FDB858	FA144	PAD230134	PAD320134	
VD-343	FDB557	FA145	PAD230135	PAD320135	
VD-345	FDB569	FA146	PAD230136	PAD320136	
VD-347	FDB606	FA147		PAD320137	
VD150	FDB2192	FA151	PAD230141		
VD-432		FA152	PAD230142	PAD320142	
VD-432/2	FDB659	FA152/2		PAD322142	
VD-943	FDB886	FA156	PAD230146	PAD320146	
VD-344	FDB574	FA158	PAD230148	PAD320148	PAD440148
		FA159	PAD230149		
VD-251	FDB666	FA160	PAD230150	PAD320150	
VD-327/2		FA161	PAD230151	PAD320151	PAD440151
VD-253		FA162	PAD230152		
VD-927		FA163		PAD320153	
VD-250	FDB631	FA165	PAD230155	PAD320155	
		FA166	PAD230156		
	FDB706	FA167	PAD230157		
VD-248/249	FDB605	FA168	PAD230158	PAD320242	PAD440242
VD-253	FDB636	FA169	PAD230159	PAD320159	
VD-941	FDB170	FA170		PAD320236	
		FA171	PAD230161		
VD-252	FDB737	FA172	PAD230162	PAD320162	
VD-425	FDB828	FA173	PAD230163		
VD-163	FDB754	FA174	PAD230164	PAD320164	PAD440164
	FDB782	FA177		PAD320167	
VD-162		FA178	PAD230168		
VD-255	FDB781	FA179	PAD230169	PAD320169	
VD-433	FDB741	FA180	PAD230170		
VD-947	FDB2039R	FA181	PAD230171	PAD320171	
VD-257	FDB637	FA182	PAD230172	PAD320172	
		FA184	PAD230174		
VD-161	FDB892	FA185	PAD230175	PAD320175	
VD-949	FDB784	FA186	PAD230176	PAD320176	
VD-154	FDB858	FA187	PAD230134	PAD320134	
VD-349	FDB873	FA188	PAD230178	PAD320178	PAD440178
VD-164	FDB2002	FA189	PAD230179	PAD320179	
VD-258	FDB864	FA190	PAD230180	PAD320180	
VD-434	FDB2012R	FA192	PAD230182	PAD320182	PAD440182
VD-948	FDB680	FA193	PAD230183	PAD320183	
	FDB677	FA194	PAD230184		
VD-156/2	FDB664	FA196	PAD232132	PAD322132	
	FDB2087	FA197	PAD230187		
		FA198	PAD230188		
VD-260	FDB2003	FA199	PAD230189	PAD320189	
VD-923	FDB521	FA200		PAD320129	
VD-340	FDB497	FA202	PAD230125	PAD320125	
VD-142	FDB462	FA203	PAD230111	PAD320111	
VD-256	FDB889	FA206	PAD230196	PAD320196	
VD-953	FDB2019	FA208	PAD230198	PAD320198	
VD-958	FDB2006	FA209	PAD230199	PAD320199	
VD-953	FDB2019	FA213	PAD230198	PAD320198	
VD340	FDB497	FA214	PAD230204	PAD320204	
VD250/250/2	FDB631	FA215	PAD230205	PAD320205	
	FDB2040	FA216	PAD230206		
	FDB2040/H	FA216/2	PAD232206		

\* Use of other brands codes for reference use only

\*\* Contains 4 pads.

Motocp  
Exhausts  
Screens  
Commuter  
Controls  
Headlights  
Indicators  
Mirrors  
Rear Lights  
Lifts & Stands  
Tools  
Batteries & Chargers  
Electrics  
Chain  
Servicing  
Tyres & Tubes  
Security  
Bike Accs  
Luggage  
Rider Accs  
Tank Pads  
Extras  
[www.bikeit.co.uk](http://www.bikeit.co.uk)



# Armstrong Racing Disc Pads

Cross Reference Guide			Armstrong	Armstrong	Armstrong
VESRAH	FERODO	EBC	GG Range	HH Range	C-PRO Range
	FDB2007	FA218	PAD230208		
VD-350	FDB570	FA222	PAD230212		
VD-156	FDB570	FA226	PAD230132	PAD320132	
VD-340	FDB497	FA228	PAD230125	PAD320125	
VD-352	FDB2048	FA229	PAD230219	PAD320219	
VD-351		FA230	PAD230220		
VD-435	FDB2049	FA231	PAD230221	PAD320221	
	FDB2054	FA232	PAD230222		
		FA233	PAD230223		
		FA234		PAD320224	
		FA235	PAD230225		
VD-343	FDB557	FA236	PAD230135	PAD320135	
VD-352	FDB2048	FA237	PAD230219	PAD320219	
VD-262	FDB2042	FA244	PAD230234	PAD320234	
VD-947	FDB2039R	FA245	PAD230235		
VD-959	FDB2050	FA246		PAD320236	
VD-248/249	FDB605	FA252	PAD230158	PAD320242	PAD440242
VD-436	FDB211	FA254	PAD230244	PAD320244	PAD440244
VD-955	FDB2037	FA255	PAD230245		
VD152	FDB438	FA256	PAD230103		
VD-162		FA257	PAD230168		
VD-438		FA258			
VD-435	FDB2049	FA259	PAD230221	PAD320221	
	FDB2057	FA260	PAD230250	PAD320250	
VD-165	FDB2073	FA261	PAD230251	PAD320251	PAD440251
		FA262		PAD320252	
VD9012	FDB2190	FA264	PAD230254		
VD-166	FDB2079	FA265	PAD230286	PAD320286	PAD440255
	FDB2074	FA266	PAD230256	PAD320256	
	FDB2084	FA267	PAD230257	PAD320257	
	FDB2062	FA268	PAD230258		
		FA269		PAD320224	
	FDB2083	FA275	PAD230265	PAD320265	
	FDB2075	FA281	PAD230271		
VD353	FDB2085	FA283	PAD230273		
		FA291	PAD230281		
		FA294	PAD230284	PAD320284	
	FDB2079	FA296	PAD230286	PAD320286	PAD440255
	FDB2090	FA298	PAD230288		
VD971	FDB2097	FA299		PAD320289	
	FDB2095	FA301	PAD230291		
	FDB2110	FA302			
	FDB2109	FA303	PAD230293		
	FDB2102	FA304		PAD320294	
	FDB2096	FA305	PAD230295		
	FDB2108	FA306	PAD230296		
		FA307	PAD230297		
	FDB2126	FA319	PAD230309	PAD320309	
		FA320		PAD320310	
		FA321	PAD230311		
	FDB2120	FA322/4		PAD320312	
		FA323	PAD230313		
		FA324	PAD230314		
		FA325			
		FA335		PAD320325	
	FDB2143	FA343	PAD230333		
	FDB2145	FA345		PAD320335	
	FDB2139	FA346	PAD230336		
	FDB2158	FA347		PAD320337	PAD440337
	FDB2150	FA348		PAD320338	
		FA350	PAD230340		
	FDB2127	FA351	PAD230341		
		FA353	PAD230343		
		FA355	PAD230345		
	FDB2157	FA357			
	FDB2039	FA363	PAD230353	PAD320353	
	FDB2163	FA366		PAD320356	

\* Use of other brands codes for reference use only

\*\* Contains 4 pads.

Motorcycle  
Exhausts  
Screens  
Commuter  
Controls  
Headlights  
Indicators  
Mirrors  
Rear Lights  
Lifts & Stands  
Tools  
Batteries & Chargers  
Electrics  
Chain  
Servicing  
Tyres & Tubes  
Security  
Bike Accs  
Luggage  
Rider Accs  
Tank Pads  
Extras  
www.bikeit.co.uk

# Armstrong Racing Disc Pads

To order Armstrong disc pads, select the required pads from the table below. Where there is a choice of compounds be sure to choose the one with the right properties for that motorcycle. See the splash page for advice about organic GG, sintered HH and sintered carbon C-PRO pads. Also visit [www.bikeit.co.uk](http://www.bikeit.co.uk) for full downloadable application list.

Cross Reference Guide			Armstrong	Armstrong	Armstrong
VESRAH	FERODO	EBC	GG Range	HH Range	C-PRO Range
	FDB2162	FA367			
	FDB2165	FA368			
	FDB2164	FA369/4		<b>PAD320359 **</b>	<b>PAD440359 **</b>
VD9013	FDB2147	FA374	<b>PAD230364</b>		
	FDB2169	FA375	<b>PAD230365</b>		
VD9026	FDB2184	FA377	<b>PAD230367</b>		
VD355		FA379		<b>PAD320369</b>	<b>PAD440369</b>
VD248	FDB605	FA380		<b>PAD320370</b>	<b>PAD440370</b>
		FA381		<b>PAD320371</b>	
		FA382	<b>PAD230372</b>		
		FA384	<b>PAD230374</b>		
		FA387		<b>PAD320377</b>	
		FA388	<b>PAD230378</b>	<b>PAD320378</b>	
VD-161	FDB892	FA389	<b>PAD230175</b>	<b>PAD320175</b>	
VD170	FDB2181	FA390		<b>PAD320380</b>	<b>PAD440380</b>
VD273		FA393	<b>PAD230383</b>		
		FA396	<b>PAD230386</b>		
	FDB2201	FA399	<b>PAD230389</b>		
VVD9022		FA400		<b>PAD320390</b>	
VD358	FDB2197	FA401			
VD959	FDB2050	FA407		<b>PAD320236</b>	
VD275	FDB2200	FA408	<b>PAD230398</b>		
VD9025		FA409		<b>PAD320399</b>	
VD356		FA411	<b>PAD230401</b>	<b>PAD320401</b>	
VD357		FA412	<b>PAD230402</b>	<b>PAD320402</b>	
VD266/2		FA413	<b>PAD230403</b>		
		FA414	<b>PAD230404</b>		
VD173		FA415	<b>PAD230405</b>		
VD354		FA417/4		<b>PAD320407 **</b>	<b>PAD440407 **</b>
		FA418	<b>PAD230408</b>		
		FA419	<b>PAD230409</b>	<b>PAD320409</b>	<b>PAD440409</b>
VD353		FA423/4		<b>PAD320413 **</b>	
		FA424		<b>PAD320414</b>	
		FA425	<b>PAD230415</b>		
		FA427	<b>PAD230417</b>		
		FA430	<b>PAD230420</b>		
		FA432	<b>PAD230422</b>	<b>PAD320422</b>	
		FA433/4		<b>PAD320423 **</b>	
		FA434		<b>PAD320424</b>	
		FA435/4		<b>PAD320425 **</b>	
		FA436	<b>PAD230426</b>	<b>PAD320426</b>	<b>PAD440426</b>
		FA442/4		<b>PAD320432 **</b>	<b>PAD440432 **</b>
		FA447		<b>PAD320437</b>	
		FA450			
		FA454		<b>PAD320444</b>	
		FA457		<b>PAD320447</b>	
VD9035	FDB2251	FA458		<b>PAD320448</b>	
		FA464	<b>PAD230454</b>		
		FA465	<b>PAD230455</b>	<b>PAD320455</b>	
		FA486	<b>PAD230476</b>		
		FA488		<b>PAD320478</b>	
		FA491		<b>PAD320481</b>	
		FA492	<b>PAD230482</b>		
		FA495	<b>PAD230485</b>		
		FA496	<b>PAD230486</b>	<b>PAD320486</b>	
		FA498	<b>PAD230488</b>		
		FA499/4		<b>PAD320489 **</b>	
		FA603	<b>PAD230593</b>		
		FA606	<b>PAD230596</b>		
		FA607	<b>PAD230597</b>		
		FA608	<b>PAD230598</b>		
		FA613		<b>PAD320603</b>	
		FA604/4		<b>PAD320594</b>	



\* Use of other brands codes for reference use only    \*\* Contains 4 pads.

Motocp  
Exhausts  
Screens  
Commuter  
Controls  
Headlights  
Indicators  
Mirrors  
Rear Lights  
Lifts & Stands  
Tools  
Batteries & Chargers  
Electrics  
Chain  
Servicing  
Tyres & Tubes  
Security  
Bike Accs  
Luggage  
Rider Accs  
Tank Pads  
Extras  
[www.bikeit.co.uk](http://www.bikeit.co.uk)



# Filtrex Foam Scooter Air Filters

New from the Filtrex camp comes a range of replacement foam air filters for scooter applications.

Supplied pre-oiled for ease of use, the filters perform to allow maximum air flow in without sacrificing protection from particles and dirt.



Model	Order Code	Model	Order Code	Model	Order Code
<b>APRILIA</b>		<b>KYMCO</b>		Fly 50cc 4-Str <i>AIRC056</i>	
Area 51 LC 2-Str	<i>AIRC052</i>	B&W 50cc 2-Str	<i>AIRC068</i>	Liberty 4-Str	<i>AIRC048</i>
Gulliver 2-Str	<i>AIRC052</i>	Dink 50cc 2-Str	<i>AIRC068</i>	Liberty 50cc 2-Str	<i>AIRC074</i>
Rally - Rally LC 2-Str	<i>AIRC052</i>	DJ Refined 50cc 2-Str	<i>AIRC084</i>	LX 50cc 4-Str	<i>AIRC056</i>
Scarabeo 2-Str Street Piaggio	<i>AIRC082</i>	DJ-Y 50cc 2-Str	<i>AIRC096</i>	MC3 DD	<i>AIRC082</i>
Sonic LC 2-Str	<i>AIRC052</i>	DJ-Yes 50cc 2-Str	<i>AIRC084</i>	MC3 DT	<i>AIRC082</i>
SR 2-Str (1994/..)	<i>AIRC052</i>	K12 50cc 2-Str	<i>AIRC084</i>	NRG Extreme 2-Str	<i>AIRC080</i>
SR 2-Str www	<i>AIRC052</i>	KB50 50cc 2-Str	<i>AIRC084</i>	NRG LC 2-Str	<i>AIRC082</i>
SR LC 2-Str (2004) Carb Piaggio	<i>AIRC088</i>	Scout 50cc 2-Str	<i>AIRC084</i>	NRG LC 2-Str (1994/1996)	<i>AIRC086</i>
SR LC 2-Str Ditech Aprilia	<i>AIRC088</i>	Super 9 - 50cc 2-Str	<i>AIRC068</i>	NRG LC 2-Str MC2 (./1997)	<i>AIRC086</i>
SR LC 2-Str Ditech GP1 Piaggio	<i>AIRC088</i>	Top Boy 50cc 2-Str	<i>AIRC068</i>	NRG LC 2-Str MC2 (1998/..)	<i>AIRC080</i>
SR LC 2-Str Netscaper / Racing (Minarelli)	<i>AIRC052</i>	Yup 50cc 2-Str	<i>AIRC068</i>	NRG LC 2-Str MC3 Extreme	<i>AIRC082</i>
SR LC 2-Str Replica	<i>AIRC052</i>	ZX 50cc 2-Str	<i>AIRC084</i>	NRG LC 2-Str MC3 Purejet / Power	<i>AIRC080</i>
SR LC 2-Str Replica 2000 (morini motor)	<i>AIRC088</i>	<b>LAVARDA</b>		NTT 2-Str LC (1995/1996)	<i>AIRC086</i>
SR LC 2-Str Stealth (Minarelli)	<i>AIRC052</i>	Quasar 50cc 2-Str	<i>AIRC098</i>	Power DD LC	<i>AIRC082</i>
Stealth 50cc 2-Str	<i>AIRC098</i>	<b>MALAGUTI</b>		Sfera RST 50cc 2-Str Restyling	<i>AIRC070</i>
Atlantic 125cc LC 4-Str	<i>AIRC046</i>	Centro 2-Str	<i>AIRC098</i>	Vespa 2-Str ET-2 (carb) ET2 2000 - LX 2-Str	<i>AIRC070</i>
Sportcity 125cc LC 4-Str (Piaggio M281M)	<i>AIRC046</i>	Ciak 2-Str	<i>AIRC098</i>	Zip 2000	<i>AIRC082</i>
Atlantic 200cc LC 4-Str (Piaggio M234M)	<i>AIRC046</i>	F10 2-Str	<i>AIRC098</i>	Zip 2-Str 4-Str	<i>AIRC090</i>
Sportcity 200cc LC 4-Str (Piaggio)	<i>AIRC046</i>	F12 Phantom	<i>AIRC098</i>	Zip 2-Str Fast Rider (1993/1994)	<i>AIRC090</i>
Atlantic 250cc LC 4-Str (Piaggio M237M)	<i>AIRC046</i>	F12 Phantom LC 2-Str	<i>AIRC098</i>	Zip 2-Str Fast Rider (1996/1997)	<i>AIRC072</i>
Sportcity 250cc LC 4-Str (Pia. M288M) i.e Euro3	<i>AIRC046</i>	F12 Phantom LC 2-Str Digit Cat	<i>AIRC098</i>	Zip SP LC 2-Str (./2000)	<i>AIRC072</i>
Atlantic 400cc LC 4-Str Sprint (Piaggio M348M)	<i>AIRC046</i>	F12 Phantom LC 2-Str Digit Cat euro 2	<i>AIRC098</i>	Zip SP LC 2-Str (2001/..)	<i>AIRC082</i>
Atlantic 500cc LC 4-Str Sprint (Piaggio M273M)	<i>AIRC046</i>	Yesterday 2-Str	<i>AIRC098</i>	Beverly 125cc - 200cc LC 4-Str	<i>AIRC046</i>
<b>BENELLI</b>		Phantom Max 200cc LC 4-Str (Piaggio)	<i>AIRC046</i>	Liberty 125cc 4-Str	<i>AIRC070</i>
491 50cc 2-Str	<i>AIRC098</i>	Madison 250cc RS LC 4-Str (Piaggio M237M)	<i>AIRC046</i>	Skipper 2-Str LX - 150cc LXT	<i>AIRC044</i>
K12 50cc 2-Str	<i>AIRC098</i>	Phantom Max 250cc LC 4-Str (Piaggio M361M)	<i>AIRC046</i>	Vespa 4-Str ET-4 (1996/1998)	<i>AIRC070</i>
<b>BETA</b>		<b>MBK</b>		Liberty 200 - 200S 4-Str (Leader)	<i>AIRC048</i>
Ark 50cc 2-Str	<i>AIRC098</i>	Booster 2-Str euro 0-1 (1990/1994)	<i>AIRC094</i>	Beverly 250cc LC 4-Str (Piaggio M285M)	<i>AIRC046</i>
Chrono 50cc 2-Str	<i>AIRC098</i>	Booster 2-Str euro 2	<i>AIRC094</i>	X9 250cc LC 4-Str Evolution (Piaggio M237M)	<i>AIRC046</i>
Quadra 50cc 2-Str	<i>AIRC098</i>	Booster NG	<i>AIRC094</i>	Beverly 400cc LC 4-Str (Piaggio M345M)	<i>AIRC046</i>
Ycon 50cc 2-Str	<i>AIRC098</i>	Booster Spirit 2-Str euro 0-1 (1996/1998)	<i>AIRC094</i>	X8 400cc LC 4-Str i.e euro 3 (Piaggio M521M)	<i>AIRC046</i>
<b>CPI</b>		Evolis 2-Str (1994-1995)	<i>AIRC098</i>	Beverly 500cc LC 4-Str i.e euro 2-3	<i>AIRC046</i>
Hussar - Oliver 50cc 2-Str (2002)	<i>AIRC052</i>	Fizz	<i>AIRC098</i>	<b>PUCH</b>	
Popcorn 50cc 2-Str (./2002)	<i>AIRC052</i>	Flipper 2-Str	<i>AIRC076</i>	NRG 50cc 2-Str	<i>AIRC086</i>
<b>DERBI</b>		Forte	<i>AIRC098</i>	NTT 50cc 2-Str	<i>AIRC086</i>
Atlantis Bullet 2-Str (2006/..)	<i>AIRC082</i>	Hot Champ 2-Str	<i>AIRC098</i>	Typhoon 50cc 2-Str	<i>AIRC086</i>
GP1 - GP1 Open LC 2-Str	<i>AIRC082</i>	Mach G	<i>AIRC098</i>	Zip o.m. 50cc 2-Str	<i>AIRC090</i>
Senda 50cc 2-Str	<i>AIRC066</i>	Mach G LC 2-Str	<i>AIRC098</i>	<b>SUZUKI</b>	
GP1 125cc LC 4-Str euro2	<i>AIRC046</i>	Naked 2-Str euro 2	<i>AIRC094</i>	Burgman 400cc LC 4-Str AN (Business)	<i>AIRC042</i>
<b>DINLI</b>		Nitro LC 2-Str	<i>AIRC098</i>	Burgman 400cc LC 4-Str AN Inject (M237M)	<i>AIRC042</i>
Helix 2-Str DL603 50cc - 90cc	<i>AIRC098</i>	Ovetto 2-Str	<i>AIRC098</i>	<b>TGB</b>	
T-Rex 50cc 2-Str	<i>AIRC098</i>	Rocket 2-Str euro 0-1	<i>AIRC094</i>	202 - 50cc 2-Str	<i>AIRC060</i>
<b>GILERA</b>		Rocket 2-Str euro 2	<i>AIRC094</i>	203 - 50cc 2-Str	<i>AIRC060</i>
Dna 50cc LC 2Str	<i>AIRC082</i>	Sorriso 2-Str (1995/..)	<i>AIRC098</i>	303- 50cc 2-Str	<i>AIRC060</i>
Ice 2Str	<i>AIRC082</i>	Stunt 2-Str euro 2	<i>AIRC094</i>	<b>YAMAHA</b>	
Runner / Runner SP LC 2-Str (./2005)	<i>AIRC080</i>	<b>PEUGEOT</b>		Aerox LC 50cc 2-Str euro 0-1-2	<i>AIRC098</i>
Runner LC 2-Str SP-Carb (2006/..)	<i>AIRC082</i>	Buxy 50cc 2-Str	<i>AIRC092</i>	Axis 50cc 2-Str	<i>AIRC098</i>
Runner LC Purejet 2-Str (./2005)	<i>AIRC080</i>	Elyseo 50cc 2-Str	<i>AIRC092</i>	Booster 50cc 2-Str	<i>AIRC094</i>
Stalker 50cc 2-Str	<i>AIRC080</i>	Elystar 50cc 2-Str	<i>AIRC058</i>	Breeze 2-Str	<i>AIRC098</i>
Storm 2-Str	<i>AIRC086</i>	Fox 50cc 2-Str	<i>AIRC062</i>	Bump 50cc 2-Str	<i>AIRC094</i>
Typhoon 2-Str	<i>AIRC086</i>	Looxor	<i>AIRC092</i>	BW's - BW's Next Generation 2-Str euro 0-1	<i>AIRC094</i>
Dna 125cc - 180cc LC 4Str	<i>AIRC050</i>	Looxor TSDI	<i>AIRC092</i>	BW's - BW's Next Generation 2-Str euro 2	<i>AIRC094</i>
Runner 125cc FX LC 2-Str 180cc FXR	<i>AIRC044</i>	Metal-X 50cc 2-Str	<i>AIRC092</i>	Jog 50cc 2-Str	<i>AIRC098</i>
Runner 125cc VX LC 4-Str (./2005) 180cc VXR	<i>AIRC050</i>	Rapido 50cc 2-Str	<i>AIRC064</i>	Jog R 50cc 2-Str	<i>AIRC098</i>
Runner 125cc VX LC 4-Str (2005/..)	<i>AIRC046</i>	Speedake 50cc 2-Str	<i>AIRC092</i>	Jogz 50cc 2-Str	<i>AIRC098</i>
200cc VXR		Speedfight 2 50cc LC 2-Str (2004)	<i>AIRC092</i>	Neo's 50cc 2-Str	<i>AIRC098</i>
Nexus 250cc LC 4-Str i.e. Euro 3	<i>AIRC046</i>	Speedfight 50cc 2-Str	<i>AIRC092</i>	Spy 50cc 2-Str	<i>AIRC094</i>
<b>HONDA</b>		Squab 50cc 2-Str	<i>AIRC092</i>	Vino	<i>AIRC098</i>
SFX 50cc 2-Str	<i>AIRC078</i>	TKR 50cc 2-Str	<i>AIRC092</i>	Why 50cc 2-Str	<i>AIRC076</i>
Vision Met-In 50cc 2-Str	<i>AIRC096</i>	Trekker	<i>AIRC092</i>	Zest 50cc 2-Str	<i>AIRC098</i>
<b>ITALJET</b>		Vivacity 50cc 2-Str	<i>AIRC092</i>	Zuma 2-Str	<i>AIRC094</i>
Dragster 125cc - 180cc LC 2-Str	<i>AIRC044</i>	X-Fight	<i>AIRC092</i>	<b>www.bikeit.co.uk</b>	
		X-Fight 2-Str	<i>AIRC092</i>		
		X-Fight LC	<i>AIRC092</i>		
		Zenith 50cc 2-Str	<i>AIRC092</i>		
		<b>PIAGGIO</b>			
		Diesis 50cc 2-Str	<i>AIRC082</i>		
		ET2 50cc 2-Str	<i>AIRC070</i>		
		ET4 50cc 4-Str	<i>AIRC054</i>		



Motocp  
Exhausts  
Screens  
Commuter  
Controls  
Headlights  
Indicators  
Mirrors  
Rear Lights  
Lifts & Stands  
Tools  
Batteries & Chargers  
Electrics  
Chain  
Scratching  
Tyres & Tubes  
Security  
Bike Accs  
Luggage  
Rider Accs  
Tank Pads  
Extras

## Armstrong Road Wavy Front Floating Brake Discs\*

Optimising performance with a more efficient area of pad contact compared to standard round discs. Laser cut from premium Japanese induction hardened stainless steel, diamond ground for the perfect finish, these discs not only look great but also offer lighter weight over standard OEM models. (All discs are sold individually).



\* All discs are Wavy Front Floating except those indicated otherwise.

Order Code	Model	Year	Diameter (mm)
------------	-------	------	---------------

Aprilia			
BKF748	RS125	92-05	320
BKF770	RS125 (radial)	06-12	320
BKF793	RS4 125 4T	11-12	300
BKF748	Tuono 125	03-04	320
BKF770	Pegaso 650 / Factory	06-08	320
BKF770	Shiver 750 / GT	07-11	320
BKF770	NA 850 Mana GT	09-12	320
BKF770	NA 850 Mana ABS	09-12	320
BKF770	RSV 1000 SP	99-00	320
BKF770	RSV 1000 R Tuono	02-08	320
BKF770	RSV 1000/R Mille	01-03	320
BKF770	RSV 1000 R / Racing / Factory	04-08	320
BKF770	RSV 1000 R Factory	04-08	320
BKF770	Tuono R / Factory	02-11	320

BMW			
BKF507	F650 CS	00-06	300
BKF507	F650 GS / Dakar	93-07	300
BKF507	F650 ST	93-00	300
BKF507	G650 GS	09-12	300
BKF529	F 800 R (fixed)	09-12	320
BKF529	F 800 S (fixed)	08-11	320
BKF531	F 800 S	06-08	320
BKF529	F 800 ST	08-11	320
BKF531	F 800 ST	06-08	320
BKF519	R 850 C	97-00	305
BKF519	R 850 C	97-01	305
BKF519	R 850 GS	96-00	305
BKF519	R 850 R	94-96	305
BKF519	R 850 RT	96-01	305
BKF503	R850 R	04-06	320
BKF509	R850 RT	06	305
BKF519	R 1100 GS	93-99	305
BKF519	R 1100 R	95-96	305
BKF519	R 1100 RT	94-01	305
BKF509	R1100 S	96-00	305
BKF503	R1100 S (ABS)	00-06	320
BKF519	R 1150 GS	98-01	305
BKF519	R 1150 GS Adventure	01-06	305
BKF503	R1150 GS Adv	03-06	320
BKF503	R1150 R	01-06	320
BKF503	R1150 R Rockster	03-06	320
BKF503	R1150 RS ABS	01-04	320
BKF503	R1150 RT ABS	00-04	320
BKF529	HP2 Megamoto	07-11	320
BKF529	HP2 Sport	08-11	320
BKF503	K1200 GT	03-06	320
BKF503	K1200 GT	06-08	320
BKF503	K1200 LT (ABS)	00-09	320
BKF503	K1200 R	05-08	320
BKF503	K1200 RS	01-04	320
BKF503	K1200 S (K40)	05-08	320
BKF519	R 1200	00-02	305
BKF519	R 1200 C	96-02	305
BKF519	R 1200 C Classic	03-04	305
BKF519	R 1200 C Independent	03-04	305
BKF527	R 1200 C Montauk	04	305

Order Code	Model	Year	Diameter (mm)
------------	-------	------	---------------

BMW cont..			
BKF527	R 1200 GS (Cast/ fixed)	10	305
BKF527	R 1200 GS Adventure (spoke/fixed)	05-07	305
BKF527	R 1200 GS Adventure (Spoke/fixed)	10	305
BKF527	R 1200 GS Adventure /M (fixed bobbins)	06-09	305
BKF527	R 1200 GS/M	06-09	305
BKF509	R 1200 GS (cast)	04-09	305
BKF509	R 1200 GS Adventure (spoke)	07-09	305
BKF525	R 1200 R (K27/0378) (Disc/fixed)	12/07-09	320
BKF529	R 1200 RT (Disc has fixed bobbins)	10-12	320
BKF531	R 1200 RT (K26/0368) (disc/loose)	05-11/07	320
BKF529	R 1200 RT SE (Disc/ fixed)	10-12	320
BKF529	R 1200 S (K29/0366) (Disc/fixed)	12/07-08	320
BKF531	R 1200 S (K29/0366) (Disc/loose)	06-11/07	320
BKF529	R 1200 ST (K28/0328) (Disc/fixed)	12/07-08	320
BKF531	R 1200 ST (K28/0328) (Disc/loose)	03-11/07	320
BKF503	R 1200 ST (K28)	03-08	320
BKF503	R 1200 Urban	06-08	320

Cagiva			
BKF768	Mito 125	91-11	320
BKF768	Raptor 125	03-11	320
BKF768	Mito 500	07-08	320

Ducati			
BKF737	600 Monster / Dark	93-99	320
BKF768	600 Monster (all models)	99-01	320
BKF768	Monster 620 IE	02-04	320
BKF768	620 Sport	03	320
BKF748	Monster 620 Dark	03-04	320
BKF768	Monster 620 IE	03-04	320
BKF772	Multistrada Dark 620	03-05	300
BKF772	Monster 620	05-06	300
BKF772	Multistrada 620	05-06	300
BKF772	695 Monster	07-08	300
BKF768	Monster 696 / +	08-09	320
BKF748	748	95-98	320
BKF737	748 SPS	98-99	320
BKF768	748 Biposto	99-02	320
BKF768	748 SP/Monoposto	99-02	320
BKF758	748 R	00-02	320
BKF760	749 / S / R	03-06	320
BKF748	750 Monster	96-99	320
BKF768	750 Monster / ie	00-02	320
BKF768	750 Supersport IE	00-02	320
BKF768	750 Sport	01-02	320

Motocp  
Exhausts  
Screens  
Commuter  
Controls  
Headlights  
Indicators  
Mirrors  
Rear Lights  
Lifts & Stands  
Tools  
Batteries & Chargers  
Electrics  
Chain  
Servicing  
Tyres & Tubes  
Security  
Bike Accs  
Luggage  
Rider Accs  
Tank Pads  
Extras  
www.bikeit.co.uk



# Armstrong Road Wavy Front Floating Brake Discs\* cont...

\* All discs are Wavy Front Floating except those indicated otherwise.

Order Code	Model	Year	Diameter (mm)
------------	-------	------	---------------

## Ducati cont..

<b>BKF768</b>	796 Hypermotard	10	320
<b>BKF768</b>	800 Sport	03	320
<b>BKF768</b>	Monster 800	03-04	320
<b>BKF768</b>	800 Supersport	03-05	320
<b>BKF772</b>	Monster S2R / Dark	05-07	300
<b>BKF760</b>	848 (Not Corse)	08-12	320
<b>BKF737</b>	900 Monster	93-99	320
<b>BKF768</b>	900 IE Monster	00-01	320
<b>BKF768</b>	900 Supersport IE	00-01	320
<b>BKF768</b>	900 Sport	02	320
<b>BKF737</b>	916	94-98	320
<b>BKF768</b>	ST4	01-02	320
<b>BKF737</b>	ST2	97-99	320
<b>BKF768</b>	ST2	00-03	320
<b>BKF709</b>	Desmosedici RR	08	330
<b>BKF768</b>	Supersport 1000 DS	03-06	320
<b>BKF768</b>	ST3 not ABS	04-07	320
<b>BKF758</b>	996 R	01	320
<b>BKF737</b>	998	02-04	320
<b>BKF760</b>	999 / S / R	03-06	320
<b>BKF768</b>	Monster 1000 (all models)	03-08	320
<b>BKF768</b>	GT1000 / Touring	07-11	320
<b>BKF768</b>	Sport 1000 S	07-09	320
<b>BKF709</b>	1098 / R / S / Tricolore	07-09	330
<b>BKF709</b>	Streetfighter 1100 / S	09-12	330
<b>BKF760</b>	1100 / S Monster	09-11	320
<b>BKF709</b>	1198 / S Superbike	09-11	330
<b>BKF709</b>	1199 Panigale S/ABS/ Tricolore	12	330

## Harley Davidson\*

<b>BKF523L</b>	Left disc - 2000 onwards	#	292
<b>BKF521L</b>	Left disc - Misc early	#	292
<b>BKF521R</b>	Right disc - Misc early	#	292
<b>BKF523L</b>	Sportster	00-11	292
<b>BKF523L</b>	Dyna	00-06	292
<b>BKF523L</b>	Softail	00-11	292
<b>BKF523L / R</b>	Touring	00-07	292
<b>BKF511L / R</b>	Touring	08-11	300

## Honda

<b>BKF702</b>	CBR400 NC23	81-89	296
<b>BKF702</b>	VFR400 NC30	89-92	296
<b>BKF702</b>	CBR400 NC29	90-94	296
<b>BKF702</b>	RVF400 NC35	94-96	296
<b>BKF711</b>	CB500	94-03	296
<b>BKF701</b>	CB600 Hornet (16")	98-99	296
<b>BKF734</b>	CB600 Hornet / S (17")	00-06	296
<b>BKF703</b>	CB600 Hornet / ABS	07-12	296
<b>BKF711</b>	CBF600 N / ABS	04-06	296
<b>BKF715</b>	CBF600 N / ABS	08-11	296
<b>BKF711</b>	CBF600 S non-ABS	04-05	296
<b>BKF715</b>	CBF600 S non-ABS	08-09	296
<b>BKF711</b>	CBF600 S ABS	04-07	296
<b>BKF715</b>	CBF600 S ABS	08-12	296
<b>BKF702</b>	CBR600 F	95-98	296
<b>BKF756</b>	CBR600 F	99-00	296
<b>BKF750</b>	CBR600 F	01-07	296
<b>BKF750</b>	CBR600 FS Sport	01-02	296
<b>BKF706</b>	CBR600RR	03-12	310
<b>BKF706</b>	CBR600RA C-ABS	09-12	320
<b>BKF702</b>	VFR750 F	94-97	296
<b>BKF756</b>	VFR800 Fi	98-05	296
<b>BKF780</b>	VFR800 (ABS)	02-09	296
<b>BKF780</b>	VFR800	06-09	296
<b>BKF750</b>	CB900 Hornet	02-07	296
<b>BKF756</b>	CBR900RR	92-93	296
<b>BKF702</b>	CBR900RR	94-97	296

Order Code	Model	Year	Diameter (mm)
------------	-------	------	---------------

## Honda cont..

<b>BKF704</b>	CBR900RR 929	00-01	330
<b>BKF704</b>	CBR900RR 954	02-03	330
<b>BKF706</b>	CB1000R / ABS	09-12	320
<b>BKF715</b>	CBF 1000	06-12	296
<b>BKF708</b>	CBR1000RR	04-05	310
<b>BKF774</b>	CBR1000RR	06-07	320
<b>BKF707</b>	CBR1000RR	08-09	320
<b>BKF707</b>	CBR1000RR C-ABS	09-12	320
<b>BKF702</b>	VTR1000 F Firestorm	97-06	296
<b>BKF752</b>	VTR1000 SP1/SP2	00-07	320
<b>BKF756</b>	XL1000 Varadero / ABS	99-09	293
<b>BKF754</b>	CB1100 X11	00-03	310
<b>BKF705</b>	CBR1100XX Blackbird	97-98	310
<b>BKF754</b>	CBR1100XX Blackbird	99-08	310
<b>BKF706</b>	CB1300 / S	05-11	310
<b>BKF756</b>	GL1500	97-03	296
<b>BKF756</b>	GL1800	01-12	296
<b>BKF750</b>	VTX1800	02-08	296

## Hyosung

<b>BKF739</b>	GT 650 R	04-12	300
---------------	----------	-------	-----

## Kawasaki

<b>BKF735</b>	EX250 Ninja	08-12	290
<b>BKF733</b>	ER-6 F/N non-ABS (A/C)	06-12	300
<b>BKF731</b>	ER-6 F/N ABS (B/D)	06-12	300
<b>BKF733</b>	KLE650 non-ABS (A/C)	07-12	300
<b>BKF730</b>	ZX6R G/J	98-01	300
<b>BKF730</b>	ZX6R A 636	02	300
<b>BKF738</b>	ZX6R B 636	03-04	280
<b>BKF738</b>	ZX6RR K/M	03-04	280
<b>BKF732</b>	ZX6RR N	05-06	300
<b>BKF732</b>	ZX6R C/P/R	05-12	300
<b>BKF729</b>	ZZR600 E	93-07	300
<b>BKF728</b>	ZX7R/RR	96-03	320
<b>BKF727</b>	Z750 / S J/K	04-07	300
<b>BKF731</b>	Z750 ABS M	07-09	300
<b>BKF733</b>	Z750 L	07-11	300
<b>BKF732</b>	Z750 R	11-12	300
<b>BKF727</b>	ZR-7 / S	99-04	300
<b>BKF728</b>	ZX9R B	94-97	320
<b>BKF730</b>	ZX9R C	98-99	300
<b>BKF726</b>	ZX9R E	00-01	310
<b>BKF728</b>	ZX9R F	02-04	320
<b>BKF786</b>	Z1000 A	03-06	300
<b>BKF732</b>	Z1000 B/C/D	07-11	300
<b>BKF732</b>	ZX10R C/D	04-07	300
<b>BKF788</b>	ZX10R E	08-12	310
<b>BKF726</b>	ZR1100 A/B	92-97, 02	310
<b>BKF726</b>	ZRX1100 C	97-00	310
<b>BKF726</b>	ZZR1100 C	90-92	310
<b>BKF728</b>	ZZR1100 D	93-01	310
<b>BKF726</b>	ZRX1200 R/S	01-08	310
<b>BKF728</b>	ZX12R A/B	00-03	320
<b>BKF786</b>	ZX12R B3-B6	04-06	300
<b>BKF728</b>	ZZR1200 C	02-04	320
<b>BKF736</b>	GTR1400 / ABS	08-12	310
<b>BKF736</b>	ZZR1400 / ABS	06-12	310
<b>BKF728</b>	VN1500 P Mean Streak	02-04	320
<b>BKF728</b>	VN1600 B Mean Streak	04-08	320

MotoCP  
 Exhausts  
 Screens  
 Commuter  
 Controls  
 Headlights  
 Indicators  
 Mirrors  
 Rear Lights  
 Lifts & Stands  
 Tools  
 Batteries & Chargers  
 Electrics  
 Chain  
 Servicing  
 Tyres & Tubes  
 Security  
 Bike Accs  
 Luggage  
 Rider Accs  
 Tank Pads  
 Extras

# Armstrong Road Wavy Front Floating Brake Discs' cont...

\* All discs are Wavy Front Floating except those indicated otherwise.

Order Code	Model	Year	Diameter (mm)
------------	-------	------	---------------

## KTM

<b>BKF737</b>	990 Superduke / R	05-12	320
<b>BKF737</b>	RC8 / R	08-12	320

## MV Agusta

<b>BKF776</b>	Brutale 750	03-08	310
<b>BKF776</b>	F4 750	99-03	310
<b>BKF776</b>	Brutale 910S	05-08	310
<b>BKF776</b>	F4 1000	04-06	310

## Suzuki

<b>BKF746</b>	GS500 EK-K3	89-03	310
<b>BKF746</b>	GS500 / F	04-08	310
<b>BKF718</b>	GSF600 Bandit	95-04	290
<b>BKF740</b>	GSR600	06-08	310
<b>BKF718</b>	GSX600 F	89-02	290
<b>BKF742</b>	GSX600 F	03-04	290
<b>BKF720</b>	GSXR600	97-03	320
<b>BKF722</b>	GSXR600	04-05	300
<b>BKF724</b>	GSXR600	06-07	310
<b>BKF790</b>	GSXR600	08-12	310
<b>BKF718</b>	RF600	93-97	290
<b>BKF744</b>	DL650 V-Strom	04-06	310
<b>BKF740</b>	DL650 V-Strom / ABS	07-12	310
<b>BKF740</b>	DL650 V-Strom Traveller	07-12	310
<b>BKF742</b>	GSF650 Bandit	05-06	290
<b>BKF723</b>	GSF650 Bandit ABS	05-06	290
<b>BKF740</b>	GSF650 Bandit / ABS	07-11	310
<b>BKF740</b>	GSX650	08-12	310
<b>BKF718</b>	SV650/S	99-02	290
<b>BKF742</b>	SV650/S non-ABS	03-12	290
<b>BKF723</b>	SV650/S ABS	07-12	290
<b>BKF742</b>	SVF650 Gladius	09-12	290
<b>BKF718</b>	GSX750 F	89-02	290
<b>BKF742</b>	GSX750 F	03-06	290
<b>BKF798</b>	GSXR750	88-95	310
<b>BKF720</b>	GSXR750	96-03	320
<b>BKF722</b>	GSXR750	04-05	300
<b>BKF724</b>	GSXR750	06-07	310
<b>BKF790</b>	GSXR750	08-12	310
<b>BKF746</b>	RF900	94-99	310
<b>BKF744</b>	DL1000 V-Strom	02-09	310
<b>BKF720</b>	GSXR1000	01-02	320
<b>BKF722</b>	GSXR1000	03-04	300
<b>BKF724</b>	GSXR1000	05-08	310
<b>BKF725</b>	GSXR1000	09-11	310
<b>BKF790</b>	GSXR1000	12	310
<b>BKF744</b>	SV1000/S	03-08	310
<b>BKF720</b>	TL1000 S/R	97-02	320
<b>BKF798</b>	GSXR1100	89-96	310
<b>BKF746</b>	GSF1200 / S Bandit	96-05	310
<b>BKF740</b>	GSF1200 / S	06	310
<b>BKF740</b>	GSF1250 / ABS Bandit	07-12	310
<b>BKF740</b>	GSF1250 Traveller	10-12	310
<b>BKF784</b>	GSX 1300 B-King	08-12	310
<b>BKF720</b>	GSX1300R Hayabusa	99-07	320
<b>BKF784</b>	GSX 1300R Hayabusa	08-12	310
<b>BKF720</b>	GSX1400	01-07	320
<b>BKF742</b>	C1800	08-12	290
<b>BKF724</b>	M1800	06-12	310

## Triumph

<b>BKF762</b>	Daytona 600	03-04	310
<b>BKF762</b>	Speedfour 600	02-05	310
<b>BKF762</b>	TT 600	00-03	310
<b>BKF762</b>	Daytona 650	05	310
<b>BKF796</b>	Daytona 675	06-12	310
<b>BKF796</b>	Daytona 675 R	11-12	310
<b>BKF796</b>	Street Triple 675	07-11	310
<b>BKF796</b>	Street Triple R 675	09-11	310
<b>BKF764</b>	Sprint RS	99-04	320

Order Code	Model	Year	Diameter (mm)
------------	-------	------	---------------

## Triumph cont..

<b>BKF764</b>	Sprint ST	99-04	320
<b>BKF764</b>	T509 Speed Triple	97-01	320
<b>BKF764</b>	T595 Daytona	97	320
<b>BKF764</b>	Daytona 955i	98-00	320
<b>BKF766</b>	Daytona 955i	01-06	320
<b>BKF766</b>	Speedtriple 955	02-04	320
<b>BKF778</b>	Speed Triple	05-07	320
<b>BKF741</b>	Speed Triple	08-12	320
<b>BKF766</b>	Sprint ST 1050	05-09	320
<b>BKF766</b>	Sprint ST 1050 ABS	09-10	320
<b>BKF778</b>	Tiger 1050	07-11	320
<b>BKF766</b>	Rocket III	04-12	320

## Yamaha

<b>BKF717</b>	FZS600 Fazer	98-03	298
<b>BKF712</b>	FZ6 ABS / Fazer	04-07	300
<b>BKF712</b>	FZ6 S2 / Fazer	07-09	300
<b>BKF710</b>	XJ600 N/S Diversion	98-03	300
<b>BKF712</b>	XJ6-N Diversion 600	09-12	300
<b>BKF712</b>	XJ6-F Diversion 600	09-12	300
<b>BKF712</b>	XJ6-S Diversion 600	09-12	300
<b>BKF710</b>	YZF600R Thundercat	96-03	300
<b>BKF710</b>	YZF-R6	99-02	300
<b>BKF712</b>	YZF-R6	03-04	300
<b>BKF716</b>	YZF-R6	05-07	310
<b>BKF792</b>	YZF-R6	08-12	310
<b>BKF712</b>	MT-03	06-12	300
<b>BKF748</b>	YZF750 R/SP	93-97	320
<b>BKF782</b>	FZ8	10-12	320
<b>BKF782</b>	Fazer 8	10-12	320
<b>BKF717</b>	TDM850	91-01	298
<b>BKF710</b>	TDM900 / ABS	02-12	300
<b>BKF721</b>	XVS950 A Midnight Star	09-11	320
<b>BKF748</b>	FZR1000 EX UP	89-95	320
<b>BKF748</b>	FZR1000 Genesis	87-88	320
<b>BKF782</b>	FZ1 / Fazer	06-12	320
<b>BKF710</b>	FZS1000 Fazer	01-05	300
<b>BKF710</b>	YZF1000R Thunderace	96-02	300
<b>BKF710</b>	YZF-R1	98-03	300
<b>BKF714</b>	YZF-R1	04-06	320
<b>BKF794</b>	YZF-R1	07-08	310
<b>BKF792</b>	YZF-R1	09-12	310
<b>BKF710</b>	BT1100 Bulldog	02-06	300
<b>BKF710</b>	V-Max	93-03	300
<b>BKF748</b>	XJR1200	95-98	320
<b>BKF710</b>	FJR1300	01-02	300
<b>BKF721</b>	FJR1300	03-12	320
<b>BKF748</b>	XJR1300 (Brembo 320mm)	98-99	320
<b>BKF710</b>	XJR1300 / SP	99-12	300
<b>BKF710</b>	XVS 1300 A Midnight Star	07-11	300
<b>BKF719</b>	MT-01 / S	05-09	320
<b>BKF710</b>	XVS 1900 A Midnight Star	06-12	300

## Brake Disc Display Plinths

Alloy display plinths with ARMSTRONG printed logo.

Plinth holds one MX solid disc or one front floating disc for retail display.

Order Code Holds  
**BKRPOS09** MX Solid Disc  
**BKRPOS11** Front Floating Disc



Motocp  
 Exhausts  
 Screens  
 Commuter  
 Controls  
 Headlights  
 Indicators  
 Mirrors  
 Rear Lights  
 Lifts & Stands  
 Tools  
 Batteries & Chargers  
 Electrics  
 Chain  
 Servicing  
 Tyres & Tubes  
 Security  
 Bike Accs  
 Luggage  
 Rider Accs  
 Tank Pads  
 Extras  
 www.bikekit.co.uk



## Armstrong Road Wavy Rear Solid Brake Discs

Optimising performance with a more efficient area of pad contact compared to standard round discs. Laser cut from premium Japanese induction hardened stainless steel, diamond ground for the perfect finish, these discs not only look great but also offer lighter weight over standard OEM models.

(All discs are sold individually)

Order Code	Model	Year	Diameter (mm)
------------	-------	------	---------------

Aprilia			
<b>BKR895</b>	RSV Mille (all models)	99-03	220
<b>BKR895</b>	RSV 1000 R/SP (all models)	99-11	220
<b>BKR895</b>	Tuono R / Factory	02-12	220
<b>BKR895</b>	RSV4 R/Factory/APRC	10-12	220

BMW			
<b>BKR847</b>	F650	93-07	240
<b>BKR847</b>	G650 GS	09-12	240
<b>BKR857</b>	R850 R	04-06	276
<b>BKR857</b>	R850 RT	06	276
<b>BKR803</b>	S 1000 RR	10-12	220
<b>BKR857</b>	R1100 S	96-00	276
<b>BKR857</b>	R1100 S (ABS)	00-06	276
<b>BKR857</b>	R1150 RT ABS	00-04	276
<b>BKR857</b>	R1150 R	01-06	276
<b>BKR857</b>	R1150 RS ABS	01-04	276
<b>BKR857</b>	R1150 GS Adv	03-06	276
<b>BKR857</b>	R1150 R Rockster	03-06	276
<b>BKR867</b>	K1200 R (Urban)	05-08	265
<b>BKR867</b>	K1200 S (K40)	05-08	265
<b>BKR867</b>	R1200 ST (K28)	03-08	265
<b>BKR867</b>	R1200 GS (cast)	04-09	265
<b>BKR867</b>	R1200 Urban	06-08	265
<b>BKR867</b>	R1200 GS Adventure (spoke)	07-09	265
<b>BKR867</b>	K1300 R	09-12	265
<b>BKR867</b>	K1300 S	09-12	265

Ducati			
<b>BKR865</b>	600 Monster / Dark	93-99	245
<b>BKR865</b>	620 Sport	03	245
<b>BKR865</b>	Monster 620 / Dark	03-06	245
<b>BKR865</b>	Monster 620 IE	03-04	245
<b>BKR865</b>	Multistrada Dark 620	03-05	245
<b>BKR865</b>	Multistrada 620	05-06	245
<b>BKR807</b>	Monster	07-08	245
<b>BKR865</b>	696 Monster	08-09	245
<b>BKR875</b>	748 R	00-02	220
<b>BKR875</b>	748 Biposto	95-98	220
<b>BKR865</b>	748 Biposto	99-02	245
<b>BKR865</b>	748 SP / Monoposto	99-02	245
<b>BKR875</b>	748 SPS	98-99	220
<b>BKR880</b>	749 / S / R	03-06	240
<b>BKR865</b>	750 Monster	96-01	245
<b>BKR865</b>	750 Supersport IE	00-02	245
<b>BKR865</b>	750 Sport	01-02	245
<b>BKR807</b>	796 Hypermotard	10-12	245
<b>BKR865</b>	800 Sport	03	245
<b>BKR865</b>	800 Supersport	03-05	245
<b>BKR865</b>	Monster 800	03-04	245
<b>BKR807</b>	Monster S2R / Dark	05-07	245
<b>BKR807</b>	848	08-12	245
<b>BKR865</b>	900 Monster / IE	93-01	245
<b>BKR865</b>	900 Supersport IE	00-01	245
<b>BKR865</b>	900 Sport	02	245
<b>BKR875</b>	916	94-98	220
<b>BKR865</b>	ST4	99-02	245
<b>BKR865</b>	ST2	97-03	245
<b>BKR880</b>	Desmosedici RR	08	240
<b>BKR865</b>	Supersport 1000 DS	03-06	245
<b>BKR865</b>	ST3 not ABS	04-07	245
<b>BKR875</b>	996	98-01	220



Order Code	Model	Year	Diameter (mm)
------------	-------	------	---------------

Ducati cont...			
<b>BKR875</b>	998	02-04	220
<b>BKR880</b>	999 / S / R	03-06	240
<b>BKR865</b>	GT1000 / Touring	07-11	245
<b>BKR865</b>	Monster 1000 all models	03-05	245
<b>BKR807</b>	Monster S2R	06-08	245
<b>BKR865</b>	Sport 1000 S	07-09	245
<b>BKR809</b>	1098 / R / S / Tricolore	07-09	245
<b>BKR809</b>	Streetfighter 1100 / S	09-12	245
<b>BKR807</b>	1100 / S Monster	09-12	245
<b>BKR807</b>	1100 Monster EVO	11-12	245

Harley Davidson			
<b>BKR887</b>	XL Sportster	00-12	292
<b>BKR887</b>	FXD Dyna	00-12	292
<b>BKR887</b>	FXST Softail	00-12	292
<b>BKR877</b>	Misc early	#	292
<b>BKR887</b>	FLHRi Touring*	00-11	292
<b>BKR899</b>	FLHR Road King	08-12	300
<b>BKR899</b>	FLHRC Road King Classic	08-12	300
<b>BKR899</b>	FLHTK Electra Glide Ultra LTD	10-12	300
<b>BKR899</b>	FLTR Road Glide	08-09	300
<b>BKR899</b>	FLTRX Road Glide Custom	10-12	300
<b>BKR899</b>	FLTRU Road Glide Ultra	11-12	300
<b>BKR899</b>	FLHTC Electra Glide Classic	08-12	300
<b>BKR899</b>	FLHTCU Ultra Classic Electra Glide	08-12	300
<b>BKR899</b>	FLHT Electra Glide Standard	08-10	300
<b>BKR899</b>	FLHX Street Glide	08-12	300

\* Except touring models listed below

Honda			
<b>BKR805</b>	CB600 Hornet	98-06	220
<b>BKR819</b>	CBF600 N / ABS	04-06	240
<b>BKR819</b>	CBF600 N / ABS	08-09	240
<b>BKR819</b>	CBF600 S non-ABS	04-05	240
<b>BKR819</b>	CBF600 S non-ABS	08-09	240
<b>BKR819</b>	CBF600 S ABS	04-07	240
<b>BKR819</b>	CBF600 S ABS	08-09	240
<b>BKR819</b>	CBF600 Hornet / ABS	08-12	240
<b>BKR805</b>	CBR600 F	91-07	220
<b>BKR805</b>	CBR600 FS Sport	01-02	220
<b>BKR805</b>	CBR600RR	03-08	220
<b>BKR897</b>	CBR600RR / C-ABS	09-12	220
<b>BKR805</b>	CBR900RR/929/954	92-03	220

Motocp  
Exhausts  
Screens  
Commuter  
Controls  
Headlights  
Indicators  
Mirrors  
Rear Lights  
Lifts & Stands  
Tools  
Batteries & Chargers  
Electrics  
Chain  
Servicing  
Tyres & Tubes  
Security  
Bike Accs  
Luggage  
Rider Accs  
Tank Pads  
Extras

## Armstrong Road Wavy Rear Solid Brake Discs cont...

Order Code	Model	Year	Diameter (mm)
------------	-------	------	---------------

### Honda cont...

<b>BKR805</b>	CBR1000RR	04-09	220
<b>BKR805</b>	CBR1000RR C-ABS	09-12	220
<b>BKR805</b>	VTR1000 F Firestorm	97-06	220
<b>BKR805</b>	VTR1000 SP1/SP2	00-07	220
<b>BKR870</b>	XL1000 Varadero	07-09	256
<b>BKR870</b>	CB1100 X11	00-03	256
<b>BKR870</b>	CBR1100XX Blackbird	97-08	256

### Hyosung

<b>BKR869</b>	GT 650/R/S	04-12	230
---------------	------------	-------	-----

### Kawasaki

<b>BKR839</b>	EX250 Ninja	08-12	220
<b>BKR840</b>	ER-6 N/F non-ABS	06-12	220
<b>BKR849</b>	ER-6 N/F ABS	06-12	220
<b>BKR830</b>	ZX6R F	95-97	230
<b>BKR840</b>	ZX6R G/J	98-01	220
<b>BKR840</b>	ZX6R A/B 636	02-04	220
<b>BKR840</b>	ZX6R K/M/N	03-06	220
<b>BKR840</b>	ZX6R C/P/R	05-12	220
<b>BKR840</b>	KLE650 non-ABS (A/C)	07-12	220
<b>BKR849</b>	KLE650 ABS (B/D)	07-12	220
<b>BKR840</b>	Z750/S	04-07	220
<b>BKR845</b>	Z750 L / ABS	07-12	250
<b>BKR840</b>	ZX9R C/E	98-01	220
<b>BKR840</b>	ZX9R F	02-04	220
<b>BKR840</b>	Z1000	03-06	220
<b>BKR845</b>	Z1000	07-12	250
<b>BKR840</b>	ZX10R C/D/E	04-11	220
<b>BKR835</b>	ZRX1100 C	97-00	250
<b>BKR835</b>	ZRX1200 R/S A/B	01-08	250
<b>BKR830</b>	ZX12R A/B	00-06	230
<b>BKR835</b>	ZZR1200 C	02-04	250
<b>BKR845</b>	ZZR1400 / ABS	06-12	250
<b>BKR845</b>	GTR1400 / ABS	08-12	250

### MV Agusta

<b>BKR879</b>	Brutale 750	03-08	210
<b>BKR879</b>	F4 750	99-03	210
<b>BKR879</b>	Brutale 910S	05-08	210
<b>BKR879</b>	F4 1000	04-06	210

### Suzuki

<b>BKR829</b>	GS500	89-08	250
<b>BKR820</b>	GSF600 Bandit	95-04	240
<b>BKR850</b>	GSR600	06-08	240
<b>BKR829</b>	GSX600 F	89-97	250
<b>BKR820</b>	GSX600 F	98-04	240
<b>BKR825</b>	GSXR600	97-12	220
<b>BKR820</b>	RF600	93-97	240
<b>BKR820</b>	GSF650 / ABS	05-06	240
<b>BKR850</b>	GSF650 Bandit / ABS	07-11	240
<b>BKR850</b>	GSX650	08-12	240
<b>BKR850</b>	SVF650 Gladius	09-12	240
<b>BKR820</b>	SV650/S	99-02	240
<b>BKR825</b>	SV650/S non-ABS	03-12	220
<b>BKR850</b>	SV650 ABS	07-12	240
<b>BKR820</b>	GSX750 F	98-06	240
<b>BKR820</b>	GSXR750	88-95	240
<b>BKR825</b>	GSXR750	96-12	220
<b>BKR820</b>	RF900	94-99	240
<b>BKR825</b>	GSXR1000	01-12	220
<b>BKR825</b>	SV1000/S	03-07	220
<b>BKR825</b>	TL1000 S/R	97-02	220
<b>BKR820</b>	GSXR1100	89-96	240
<b>BKR820</b>	GSF1200 / S Bandit	96-05	240

Order Code	Model	Year	Diameter (mm)
------------	-------	------	---------------

### Suzuki cont...

<b>BKR850</b>	GSF1200 / S Bandit	06	240
<b>BKR850</b>	GSF1250 / S Bandit	07-12	240
<b>BKR850</b>	GSF1250 Traveller	10-12	240
<b>BKR827</b>	GSX 1300 B-King	08-12	260
<b>BKR820</b>	GSX1300R Hayabusa	99-07	240
<b>BKR827</b>	GSX 1300R Hayabusa	08-12	260

### Triumph

<b>BKR885</b>	Daytona 600	03-04	220
<b>BKR885</b>	Speedfour 600	02-05	220
<b>BKR885</b>	TT 600	00-03	220
<b>BKR885</b>	Daytona 650	05	220
<b>BKR885</b>	Daytona 675	06-12	220
<b>BKR885</b>	Street Triple 675	07-11	220
<b>BKR885</b>	Street Triple R 675	09-11	220
<b>BKR890</b>	Sprint RS	99-04	255
<b>BKR890</b>	Sprint ST	99-04	255
<b>BKR885</b>	T 595 Daytona	97	220
<b>BKR885</b>	T509 Speed Triple	97-01	220
<b>BKR885</b>	Daytona 955i	98-04	220
<b>BKR885</b>	Daytona 955i	05-06	220
<b>BKR885</b>	Speed Triple	02-04	220
<b>BKR890</b>	Sprint ST 1050	05-09	255
<b>BKR889</b>	Sprint ST 1050 ABS	09-12	255
<b>BKR885</b>	Speed Triple 1050 (Nissin)	05-07	220
<b>BKR885</b>	Speed Triple 1050 (Brembo)	08-12	220
<b>BKR890</b>	Tiger 1050	07-12	255

### Yamaha

<b>BKR855</b>	FZ6 ABS / Fazer	04-07	245
<b>BKR855</b>	FZ6 S2 / Fazer	07-09	245
<b>BKR865</b>	FZS600 Fazer	98-03	245
<b>BKR865</b>	XJ600 N/S Diversion	92-03	245
<b>BKR855</b>	XJ6-N Diversion 600	09-12	245
<b>BKR855</b>	XJ6-F Diversion 600	10-12	245
<b>BKR855</b>	XJ6-S Diversion 600	09-12	245
<b>BKR865</b>	YZF600R Thundercat	96-03	245
<b>BKR810</b>	YZF-R6	99-02	220
<b>BKR815</b>	YZF-R6	03-12	220
<b>BKR855</b>	MT-03	06-12	245
<b>BKR865</b>	YZF750 R/SP	93-97	245
<b>BKR865</b>	TDM 850	91-01	245
<b>BKR865</b>	TDM900	02-12	245
<b>BKR860</b>	FZR1000 EX UP	89-95	267
<b>BKR860</b>	FZR1000 Genesis	87-88	267
<b>BKR855</b>	FZ1 / Fazer	06-12	245
<b>BKR860</b>	FZS1000 Fazer	01-05	267
<b>BKR865</b>	YZF1000R Thunderace	96-02	245
<b>BKR817</b>	YZF R1	98-01	245
<b>BKR810</b>	YZF-R1	02-03	220
<b>BKR815</b>	YZF-R1	04-12	220
<b>BKR860</b>	BT1100 Bulldog	02-06	267
<b>BKR860</b>	XJR1200	95-98	267
<b>BKR837</b>	FJR1300	01-05	282
<b>BKR860</b>	XJR1300 / SP	98-12	267
<b>BKR860</b>	MT-01 / S	05-09	267





## Fuel Filters

Order Code	Description
<b>FFT516CHG</b>	8mm chrome/glass fuel filter
<b>FFTSTD</b>	6mm regular size inline filter (Per card of 10)
<b>FFTSQ</b>	6mm square MRC type filter (Per card of 30)
<b>FFTCL</b>	6mm round clear type filter (Per card of 10)
<b>FFTGLA</b>	Glass Fitter with three adaptors 1/4", 5/16", 3/8"
<b>FFT001</b>	8mm inline filter (Per card of 10)



FFT516CHG



FFTSTD



FFTSQ



FFTCL



FFTGLA



FFT001

FFT001

## Fuel Taps

**NEW**

Order Code	Description
<b>FFTTAP09</b>	Dual on/off positions 6mm, plastic bodied
<b>FFTTAP11</b>	Dual on/off positions 8mm, plastic bodied
<b>FFTTAP13</b>	Dual on/off positions, metal bodied 8mm

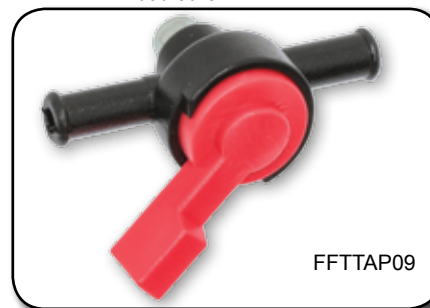

FFTTAP09



FFTTAP11



FFTTAP13

## Quick Release Fuel Line Coupler

Simple in-line fuel hose coupler allows quick and safe removal of petrol tank without fuel spillage. Each end of the coupler features a valve mechanism which permits fuel flow when the coupler is secured, but instantly isolates the fuel when the coupler is released. Available for 6mm and 8mm fuel hose.

Order Code	Fits
<b>FLCP06</b>	6mm fuel hose
<b>FLCP08</b>	8mm fuel hose



## Original Fuel Filters

Order Code	Colour
<b>FFTANBU</b>	Blue
<b>FFTCH</b>	Chrome
<b>FFTANGD</b>	Gold
<b>FFTANR</b>	Red



## Fuel Hose & Clips

Order Code	Description
<b>FUP6MM</b>	7.5m / 25ft roll Fuel hose for 6mm filters
<b>FUP8MM</b>	7.5m / 25ft roll Fuel hose for 8mm filters
<b>HOSCLIP7</b>	Hose clips 7.8mm (Per 10)



Motoclip  
Exhausts  
Screens  
Commuter  
Controls  
Headlights  
Indicators  
Mirrors  
Rear Lights  
Lifts & Stands  
Tools  
Batteries & Chargers  
Electrics  
Chain  
Servicing  
Tyres & Tubes  
Security  
Bike Accs  
Luggage  
Rider Accs  
Tank Pads  
Extras



# AIR FILTERS

**FILTREX PERFORMANCE REPLACEMENT AIR FILTERS GUARANTEED TO INCREASE HORSEPOWER AND ACCELERATION. PROFESSIONALLY ENGINEERED WITH A PREMIUM FILTRATION MATERIAL SET WITHIN A HIGH SPECIFICATION CHASSIS, FILTREX WILL DELIVER INCREASED PERFORMANCE AND LONGEVITY OVER OEM AND OTHER AFTERMARKET FILTERS.**



# FILTREX

[WWW.FILTREXOEM.COM](http://WWW.FILTREXOEM.COM)



**FILTREX HEAVY-DUTY OIL FILTERS ARE SUPPLIED TO MAJOR ORIGINAL EQUIPMENT MANUFACTURERS WORLDWIDE. MANUFACTURED TO EXACT JAPANESE INDUSTRY STANDARDS. ORIGINAL EQUIPMENT PRODUCT WITHOUT ORIGINAL EQUIPMENT PRICE!**

# OIL FILTERS

**OPTIMUM PERFORMANCE O.E.M.**



## Filtrex Oil Filters

Filtrex Heavy-Duty Hi-Flow filters are supplied to major original equipment manufacturers worldwide, with further compliance to Japanese Industry Standards. This enables you to give your customer the comfort of choosing an original equipment product at a fraction of the price.



### CROSS-REFERENCE CHART

Filtrex	Hiflo Equiv	Champion Equiv
OIF001	HF401	X303, X315
OIF002	HF111	X304, X322
OIF003	HF202	F302
OIF004	HF112	X301
OIF005	HF158	
OIF006	HF303, HF127	F301, F306, F304
OIF007	HF126	X314
OIF008	HF123	X310
OIF009	HF125	X324
OIF010	HF133	X307, X309, X323
OIF011	HF131	X327
OIF012	HF137	X308
OIF013	HF136	X319
OIF014	HF134	C303
OIF015	HF138	K301
OIF016	HF144	X306
OIF017	HF146	X311
OIF018	HF145	X302
OIF019	HF143	X313
OIF020	HF147	F307
OIF021	HF142	X313
OIF022	HF132	X328
OIF023	HF153	C302
OIF024	HF204	F308
OIF025	HF191	
OIF026	HF183	C320
OIF027	HF151	X305
OIF028	HF148	
OIF029	HF113	X301
OIF030	HF115	
OIF031	HF141	
OIF032	HF152	X312
OIF033	HF185	X325
OIF034	HF155	X320
OIF035	HF156	F303
OIF036	HF170C	
OIF037	HF170B	C306
OIF038	HF173C	C307
OIF039	HF171C	C306
OIF040	HF157	X335
OIF041	HF163	C312
OIF042	HF172	
OIF043	HF181	X330
OIF044	HF207	
OIF045	HF116	
OIF046	HF139	
OIF047	HF553	
OIF048	HF164	
OIF049	HF177	
OIF050	HF154	
OIF051	HF681	
OIF052	HF554	
OIF053	HF184	
OIF054	HF655	
OIF055	HF652	
OIF057		
OIF058	HF556	
OIF059	HF140	
OIF060	HF174C	



Filtrex - OIF001  
Hiflo - HF401  
Champion - X303, X315



Filtrex - OIF002  
Hiflo - HF111  
Champion - X304, X322



Filtrex - OIF003  
Hiflo - HF202  
Champion - F302



Filtrex - OIF004  
Hiflo - HF112  
Champion - X301



Filtrex - OIF005  
Hiflo - HF158  
Champion -



Filtrex - OIF006  
Hiflo - HF303, HF127  
Champion - F301, F306, F304



Filtrex - OIF007  
Hiflo - HF126  
Champion - X314



Filtrex - OIF008  
Hiflo - HF123  
Champion - X310



Filtrex - OIF009  
Hiflo - HF125  
Champion - X324



Filtrex - OIF010  
Hiflo - HF133  
Champion - X307, X309, X323



Filtrex - OIF011  
Hiflo - HF131  
Champion - X327



Filtrex - OIF012  
Hiflo - HF137  
Champion - X308

\* Use of other brands codes for reference use only

Motorcycle  
Exhausts  
Screens  
Commuter  
Controls  
Headlights  
Indicators  
Mirrors  
Rear Lights  
Lifts & Stands  
Tools  
Batteries & Chargers  
Electrics  
Chain  
Scrapping  
Tyres & Tubes  
Security  
Bike Accs  
Luggage  
Rider Accs  
Tank Pads  
Extras

www.bikeit.co.uk

**Filtrex Oil Filters cont...**



*Filtrex - OIF013*  
Hiflo - HF136  
Champion - X319



*Filtrex - OIF014*  
Hiflo - HF134  
Champion - C303



*Filtrex - OIF015*  
Hiflo - HF138  
Champion - K301



*Filtrex - OIF016*  
Hiflo - HF144  
Champion - X306



*Filtrex - OIF017*  
Hiflo - HF146  
Champion - X311



*Filtrex - OIF018*  
Hiflo - HF145  
Champion - X302



*Filtrex - OIF019*  
Hiflo - HF143  
Champion - X313



*Filtrex - OIF020*  
Hiflo - HF147  
Champion - X307



*Filtrex - OIF021*  
Hiflo - HF142  
Champion - X313



*Filtrex - OIF022*  
Hiflo - HF132  
Champion - X328



*Filtrex - OIF023*  
Hiflo - HF153  
Champion - C302



*Filtrex - OIF024*  
Hiflo - HF204  
Champion - F308



*Filtrex - OIF025*  
Hiflo - HF191  
Champion -



*Filtrex - OIF026*  
Hiflo - HF183  
Champion - C320



*Filtrex - OIF027*  
Hiflo - HF151  
Champion - X305



*Filtrex - OIF028*  
Hiflo - HF148  
Champion -



*Filtrex - OIF029*  
Hiflo - HF113  
Champion - X301



*Filtrex - OIF030*  
Hiflo - HF115  
Champion -



*Filtrex - OIF031*  
Hiflo - HF141  
Champion -



*Filtrex - OIF032*  
Hiflo - HF152  
Champion - X312

MotoGP  
Exhausts  
Screens  
Commuter  
Controls  
Headlights  
Indicators  
Mirrors  
Rear Lights  
Lifts & Stands  
Tools  
Batteries & Chargers  
Electrics  
Chain  
Servicing  
Tyres & Tubes  
Security  
Bike Accs  
Luggage  
Rider Accs  
Tank Pads  
Extras  
[www.bikekit.co.uk](http://www.bikekit.co.uk)





*Filtrex - OIF033*  
Hiflo - HF185  
Champion - X325



*Filtrex - OIF034*  
Hiflo - HF155  
Champion - X320



*Filtrex - OIF035*  
Hiflo - HF156  
Champion - F303



*Filtrex - OIF036*  
Hiflo - HF170C  
Champion -



*Filtrex - OIF037*  
Hiflo - HF170B  
Champion - C306



*Filtrex - OIF038*  
Hiflo - HF173C  
Champion - C307



*Filtrex - OIF039*  
Hiflo - HF171C  
Champion - C306



*Filtrex - OIF040*  
Hiflo - HF157  
Champion - X335



*Filtrex - OIF041*  
Hiflo - HF163  
Champion - C312



*Filtrex - OIF042*  
Hiflo - HF172  
Champion -



*Filtrex - OIF043*  
Hiflo - HF181  
Champion - X330



*Filtrex - OIF044*  
Hiflo - HF207  
Champion -



*Filtrex - OIF045*  
Hiflo - HF116  
Champion -



*Filtrex - OIF046*  
Hiflo - HF139  
Champion -



*Filtrex - OIF047*  
Hiflo - HF553  
Champion -



*Filtrex - OIF048*  
Hiflo - HF164  
Champion -



*Filtrex - OIF049*  
Hiflo - HF177  
Champion -



*Filtrex - OIF050*  
Hiflo - HF154  
Champion -



*Filtrex - OIF051*  
Hiflo - HF681  
Champion -



*Filtrex - OIF052*  
Hiflo - HF554  
Champion -

Motocycle  
Exhausts  
Screens  
Commuter  
Controls  
Headlights  
Indicators  
Mirrors  
Rear Lights  
Lifts & Stands  
Tools  
Batteries & Chargers  
Electrics  
Chain  
Servicing  
Tyres & Tubes  
Security  
Bike Accs  
Luggage  
Rider Accs  
Tank Pads  
Extras

## Filtrex Oil Filters cont...



Filtrex - OIF053  
Hiflo - HF184  
Champion -



Filtrex - OIF054  
Hiflo - HF655  
Champion -



Filtrex - OIF055  
Hiflo - HF652  
Champion -



Filtrex - OIF057  
Hiflo -  
Champion -



Filtrex - OIF058  
Hiflo - HF556  
Champion -



Filtrex - OIF059  
Hiflo - HF140  
Champion -



Filtrex - OIF060  
Hiflo - HF174C  
Champion -

## Bleed Nipple Cover

Silicone replacement bleed nipple cover, prevents dirt and debris clogging up brake caliper bleed nipple

Order Code:  
NIP012



**NEW**

## Filtrex Oil Filters - Catalogue

A totally comprehensive application guide is now available detailing the full range of Filtrex Oil Filters.

Listings are provided by bike model, together with cross-reference data, recommended installation instructions and tool guide.

Order Code: OIFCAT12

**NEW**



Visit our web site:  
[www.filtrexoem.com](http://www.filtrexoem.com)

## NTN/SNR Original Equipment Bearings

Order Code	Type
BEA600DDU	600DDU RS
BEA601DDU	6001DDU RS
BEA602DDU	6002DDU RS
BEA6003DDU	6003DDU RS
BEA6004DDU	6004DDU RS
BEA6005DDU	6005DDU RS
BEA6006DDU	6006DDU RS
BEA6007DDU	6007DDU RS
BEA6022DDU	6022DDU RS
BEA6028DDU	6028DDU RS
BEA6032DDU	6032DDU RS
BEA6200DDU	6200DDU RS
BEA6201DDU	6201DDU RS
BEA6202DDU	6202DDU RS
BEA6203DDU	6203DDU RS
BEA6204DDU	6204DDU RS
BEA6205DDU	6205DDU RS
BEA6206DDU	6206DDU RS

Order Code	Type
BEA6222DDU	6222DDU RS
BEA6232DDU	6232DDU RS
BEA6300DDU	6300DDU RS
BEA6301DDU	6301DDU RS
BEA6302DDU	6302DDU RS
BEA6303DDU	6303DDU RS
BEA6304DDU	6304DDU RS
BEA6305DDU	6305DDU RS
BEA6322DDU	6322DDU RS
BEA6904DDU	6904DDU RS
BEA6905DDU	6905DDU RS
BEA6906DDU	6906DDU RS



**NTN/SNR Bearings are certified O.E. suppliers to the four major Japanese motorcycle manufacturers, in addition to Ducati & MV Agusta.**

\* Bike It reserve the right to supply alternative brand of equivalent quality.

MotoGP  
Exhausts  
Screens  
Commuter  
Controls  
Headlights  
Indicators  
Mirrors  
Rear Lights  
Lifts & Stands  
Tools  
Batteries & Chargers  
Electrics  
Chain  
Servicing  
Tyres & Tubes  
Security  
Bike Accs  
Luggage  
Rider Accs  
Tank Pads  
Extras  
[www.bikeit.co.uk](http://www.bikeit.co.uk)



## Steering Head Bearings

Replacement Japanese steering head bearings. Sold individually. Order top and bottom bearings separately.



Model	Year	Fitment	Bearing Type	Order Code
<b>Honda</b>				
CBR1000 F	03-04	Top	32006J	<b>BEASTR02</b>
CBR100 RR	04-09	Top	32006J	<b>BEASTR02</b>
CBR100 RR	03-10	Top	32006J	<b>BEASTR02</b>
VTR1000 Firestorm		Top	32006J	<b>BEASTR02</b>
CBR1000 F	03-04	Bottom	32005/26	<b>BEASTR04</b>
CBR1000 RR	04-09	Bottom	32005/26	<b>BEASTR04</b>
CBR600 RR	03-10	Bottom	32005/26	<b>BEASTR04</b>
VTR1000 Firestorm		Bottom	32005/26	<b>BEASTR04</b>

<b>Kawasaki</b>				
Z1000	03-06	Top & Bottom	32907JR-3	<b>BEASTR06</b>
ZX7R	96-03	Top & Bottom	32907JR-3	<b>BEASTR06</b>
ZX9R	94-99	Top & Bottom	32907JR-3	<b>BEASTR06</b>
ZX636	03-04	Top	32907JR-3	<b>BEASTR06</b>
ZX9R	00-04	Top	32907JR-3	<b>BEASTR06</b>
ZX6R	95-97	Bottom	32005J	<b>BEASTR08</b>
ZX6R	98-04	Bottom	32005J	<b>BEASTR08</b>
ZX636	03-04	Bottom	32005J	<b>BEASTR08</b>
ZX9R	00-04	Bottom	32005J	<b>BEASTR08</b>
ZX6R	95-97	Top	320/28JR	<b>BEASTR10</b>
ZX6R	98-04	Top	320/28JR	<b>BEASTR10</b>

<b>Suzuki</b>				
GSF1200 Bandit	96-06	Top	32006J	<b>BEASTR02</b>
GSF600 Bandit	96-04	Top	32006J	<b>BEASTR02</b>
GSXR750	85-95	Top	32006J	<b>BEASTR02</b>
GSXR750	96-K3	Top & Bottom	32006J	<b>BEASTR02</b>
GSXR600	97-K3	Top & Bottom	32006J	<b>BEASTR02</b>
GSX1300R	99-04	Top & Bottom	32006J	<b>BEASTR02</b>
GSF1200 Bandit	96-06	Bottom	32005J	<b>BEASTR08</b>
GSF600 Bandit	96-04	Bottom	32005J	<b>BEASTR08</b>
GSXR750	85-95	Bottom	32005J	<b>BEASTR08</b>
GSXR750	96-K3	Bottom	32005J	<b>BEASTR08</b>
GSXR600	97-K3	Bottom	32005J	<b>BEASTR08</b>
GSX1300R	99-04	Bottom	32005J	<b>BEASTR08</b>

<b>Yamaha</b>				
YZF600 R6	99-04	Top & Bottom	32006J	<b>BEASTR02</b>
YZF1000 R1	99-04	Top & Bottom	32006J	<b>BEASTR02</b>



## Fork Stroke Indicators

A very simple but handy accessory. These fork indicators simply slide onto fork legs against the dust seal. As the forks compress the indicator is pushed up the leg, clearly showing fork performance.

Order Code	Description
<b>FKSIND41</b>	41mm / Pair
<b>FKSIND43</b>	43mm / Pair
<b>FKSIND46</b>	46mm / Pair
<b>FKSIND47</b>	47mm / Pair
<b>FKSIND48</b>	48mm / Pair
<b>FKSIND50</b>	50mm / Pair



## Japanese Industry Standard Original Equipment Fork Oil Seal

Order Code	Size (mm)
<b>FKS028</b>	25 x 35 x 9
<b>FKS009</b>	26 x 36 x 10.5
<b>FKS017</b>	26 x 37 x 10.5
<b>FKS018</b>	27 x 37 x 7.5
<b>FKS006</b>	27 x 39 x 10.5
<b>FKS027</b>	28 x 38 x 7
<b>FKS022</b>	28 x 40 x 10.5
<b>FKS023</b>	28 x 40.5 / 41 x 10.5
<b>FKS047</b>	30 x 40 x 7
<b>FKS010</b>	30 x 40.5 x 10.5
<b>FKS007</b>	30 x 42 x 10.5
<b>FKS037</b>	31 x 41 x 9
<b>FKS032</b>	31 x 41 x 11
<b>FKS005</b>	31 x 43 x 10
<b>FKS029</b>	31 x 43 x 12.5
<b>FKS035</b>	32 x 42 x 8
<b>FKS014</b>	32 x 43 x 12.5
<b>FKS030</b>	32 x 44 x 10.5
<b>FKS048</b>	33 x 39 x 4
<b>FKS016</b>	33 x 45 x 11
<b>FKS008</b>	33 x 46 x 10.5
<b>FKS052</b>	33 x 46 x 11
<b>FKS033</b>	33 x 46 x 12.5
<b>FKS049</b>	34 x 39 x 3
<b>FKS019</b>	34 x 46 x 10.5
<b>FKS036</b>	35 x 47 x 7.5
<b>FKS060</b>	35 x 47 x 10
<b>FKS046</b>	35 x 48 x 9.5
<b>FKS012</b>	35 x 48 x 11
<b>FKS015</b>	35 x 48 x 13
<b>FKS065</b>	35 x 50 x 11
<b>FKS034</b>	36 x 48 x 9.5
<b>FKS011</b>	36 x 48 x 10.5
<b>FKS025</b>	37 x 48 x 10.5
<b>FKS040</b>	37 x 48 x 12.5
<b>FKS001</b>	37 x 49 x 8
<b>FKS020</b>	37 x 49 x 10
<b>FKS013</b>	37 x 50 x 11
<b>FKS061</b>	38 x 48 x 10
<b>FKS002</b>	38 x 50 x 8
<b>FKS041</b>	38 x 50 x 10.5
<b>FKS044</b>	38 x 52 x 11
<b>FKS043</b>	39 x 51 x 8
<b>FKS031</b>	39 x 52 x 11
<b>FKS004</b>	40 x 52 x 9.5
<b>FKS062</b>	40 x 52 x 10 / 10.5
<b>FKS003</b>	41 x 53 x 8
<b>FKS051</b>	41 x 53 x 9.5
<b>FKS021</b>	41 x 53 x 10.5
<b>FKS024</b>	41 x 54 x 11
<b>FKS063</b>	43 x 54 x 9.5
<b>FKS038</b>	43 x 54 x 11
<b>FKS045</b>	43 x 55 x 9
<b>FKS042</b>	43 x 55 x 10.5
<b>FKS039</b>	45 x 57 x 11
<b>FKS064</b>	46 x 58 x 9 / 9.5
<b>FKS053</b>	46 x 58 x 10.5
<b>FKS054</b>	47 x 58 x 10
<b>FKS058</b>	48 x 58 x 9.5
<b>FKS056</b>	48 x 58.1 x 10.5
<b>FKS055</b>	49 x 60 x 10



Motorcycles  
 Exhausts  
 Screens  
 Commuter  
 Controls  
 Headlights  
 Indicators  
 Mirrors  
 Rear Lights  
 Lifts & Stands  
 Tools  
 Batteries & Chargers  
 Electrics  
 Chain  
 Servicing  
 Tyres & Tubes  
 Security  
 Bike Accs  
 Luggage  
 Rider Accs  
 Tank Pads  
 Extras  
 www.bikeit.co.uk

## Filtrex Replacement Air Filters



Replacement air filters for street bikes, hi-performance filtration prevents dirt and debris passing into the engine, aids optimal airflow ensuring clean and efficient engine running. Direct replacements for OEM filters.

Model	Year	Order Code
<b>CAGIVA</b>		
650 Raptor	00-05	<b>ARF180</b>
650 V-Raptor	01-04	<b>ARF180</b>
1000 Raptor	00-05	<b>ARF174</b>
1000 V-Raptor	00-04	<b>ARF174</b>
1000 Xtra-Raptor	01-05	<b>ARF174</b>
<b>HONDA</b>		
CA125 S Rebel	95-02	<b>ARF118</b>
CBR125 R/RW	04-12	<b>ARF252</b>
@125	00-02	<b>ARF136</b>
NES125 Chiocciola	00-07	<b>ARF136</b>
PS125 i	06-11	<b>ARF136</b>
SES125 Dylan	02-07	<b>ARF136</b>
SH125 all models	01-12	<b>ARF136</b>
NES150 Chiocciola	00-07	<b>ARF136</b>
PS150 i	06-11	<b>ARF136</b>
SES150 Dylan	02-07	<b>ARF136</b>
SH150 all models	01-12	<b>ARF136</b>
CB250 N Two Fifty	91-02	<b>ARF106</b>
CB250 Nighthawk	91-08	<b>ARF106</b>
FSC400 Silver Wing	06-12	<b>ARF122</b>
CB500 R-2	94-02	<b>ARF104</b>
CB500 S-W-2	98-02	<b>ARF104</b>
CBF500 / ABS	04-08	<b>ARF112</b>
CB600 F Hornet W-6	98-06	<b>ARF112</b>
CB600 F Hornet 7-C	07-12	<b>ARF254</b>
CB600 S Hornet	00-03	<b>ARF112</b>
CBF600 N/NA	04-07	<b>ARF112</b>
CBF600 S/SA	04-07	<b>ARF112</b>
CBF600 N/NA	08-11	<b>ARF254</b>
CBF600 S/SA	08-12	<b>ARF254</b>
CBR600 FX-FY	99-00	<b>ARF110</b>
CBR600 F 1-7	01-07	<b>ARF256</b>
CBR600 F/FA	11-12	<b>ARF254</b>
CBR600RR	03-06	<b>ARF132</b>
CBR600RR 7-C	07-12	<b>ARF258</b>
CBR600RA 9-C (ABS)	09-12	<b>ARF258</b>
FSC600 Silver Wing / ABS	01-12	<b>ARF122</b>
CB750 F2-N-Y	92-00	<b>ARF102</b>
CB750 Seven Fifty	01-02	<b>ARF102</b>
VT750 C/CD/CD2 Shadow	97-03	<b>ARF114</b>
VT750 DC Shadow Spirit	01-07	<b>ARF114</b>
VFR800	98-03	<b>ARF120</b>
VFR800 V-Tec / ABS	02-11	<b>ARF120</b>
VFR800 Crossrunner B-C	11-12	<b>ARF120</b>
CB900 F Hornet (CB919)	02-07	<b>ARF126</b>
CBR900RR Fireblade	02-03	<b>ARF134</b>
CBR954RR Fireblade	02-03	<b>ARF134</b>
CBF1000	06-10	<b>ARF268</b>
CBR1000RR **	04-07	<b>ARF130</b>
VTR1000 F Fire Storm	97-05	<b>ARF116</b>

Model	Year	Order Code
<b>HONDA cont...</b>		
VTR1000 SP-1/SP-2 **	01-06	<b>ARF128</b>
XL1000 Varadero X-2	99-02	<b>ARF116</b>
XL1000 Varadero 3-C / ABS	03-12	<b>ARF138</b>
CBR1100 XX Blackbird X-6	99-06	<b>ARF108</b>
X-11	00-03	<b>ARF108</b>
CB1300 F / ABS	03-10	<b>ARF124</b>
CB1300 S/SA (ABS)	05-12	<b>ARF124</b>

\*\* please order 2 filters

<b>KAWASAKI</b>		
Ninja 250R (EX250)	08-12	<b>ARF260</b>
GPZ500 S (EX500)	87-03	<b>ARF140</b>
Ninja 500R (EX500)	04-09	<b>ARF140</b>
ER-5 A-C	96-06	<b>ARF146</b>
ER-6F/N A/B	06-08	<b>ARF158</b>
ZX6-R Ninja G	98-99	<b>ARF152</b>
ZX6-R Ninja J/A1P	00-02	<b>ARF152</b>
ZX6-R Ninja B	03-04	<b>ARF164</b>
ZX6-RR Ninja K/M	03-04	<b>ARF164</b>
ZZR600	05-08	<b>ARF152</b>
KLE650 Versys	08-12	<b>ARF158</b>
Ninja 650R A/C	06-10	<b>ARF158</b>
ZR-7 / S (ZR750)	99-03	<b>ARF142</b>
Z750 S K/M (ABS)	05-09	<b>ARF154</b>
Z750 J/L/M (ABS)	04-12	<b>ARF154</b>
Z750 R N/P (ABS)	11-12	<b>ARF154</b>
ZR750 Zephyr C/D	91-99	<b>ARF142</b>
VN800 A-E all models	95-06	<b>ARF160</b>
ZX-9R C/E/F	98-03	<b>ARF150</b>
Z1000 A/B/C (ABS)	03-09	<b>ARF154</b>
ZX-10R Ninja C/D	04-07	<b>ARF156</b>
ZR1100 Zephyr C	99-06	<b>ARF148</b>
ZRX1200 R/S	01-06	<b>ARF148</b>
GTR1400 A-D (ABS)	08-12	<b>ARF162</b>
ZX-14R Ninja A/D	06-11	<b>ARF162</b>
ZZR1400 A-D	06-12	<b>ARF162</b>
VN1500 all models	96-08	<b>ARF144</b>
VN1600 all models	04-08	<b>ARF144</b>

<b>SUZUKI</b>		
AN125	96-00	<b>ARF182</b>
GZ125 Marauder	99-10	<b>ARF200</b>
GS500 E	88-02	<b>ARF178</b>
GS500 E (2 cyl)	88-02	<b>ARF166</b>
GS500 / H	03-09	<b>ARF166</b>
GS500 F	04-10	<b>ARF166</b>
GSF600 / S Bandit	95-99	<b>ARF168</b>
GSF600 S Y-K4 Bandit	00-04	<b>ARF184</b>
GSF600 Y-K4 Bandit	00-04	<b>ARF184</b>
GSR600 K6-L0	06-10	<b>ARF198</b>
GSX600 F L-Y	90-00	<b>ARF170</b>

Motocp  
Exhausts  
Screens  
Commuter  
Controls  
Headlights  
Indicators  
Mirrors  
Rear Lights  
Lifts & Stands  
Tools  
Batteries & Chargers  
Electrics  
Chain  
Servicing  
Tyres & Tubes  
Security  
Bike Accs  
Luggage  
Rider Accs  
Tank Pads  
Extras



## Filtrex Replacement Air Filters

Model	Year	Order Code
<b>SUZUKI cont...</b>		
GSX600 F K1-K6	01-06	<b>ARF170</b>
GSX-R600 W N-P	92-93	<b>ARF168</b>
GSX-R600 V-Y	97-00	<b>ARF176</b>
GSX-R600 K1-K3	01-03	<b>ARF188</b>
GSX-R600 K4-K5	04-05	<b>ARF208</b>
GSX-R600 K6-L0	06-10	<b>ARF204</b>
DL650 A V-Strom Traveller /GT	10	<b>ARF194</b>
DL650 V-Strom K4-K6	04-06	<b>ARF192</b>
DL650 V-Strom / ABS K7-L2	07-12	<b>ARF194</b>
GSF650 / S Bandit	05-08	<b>ARF206</b>
SFV650 Gladius	09-12	<b>ARF262</b>
SV650 S X-K2	99-02	<b>ARF180</b>
SV650 X-K2	99-02	<b>ARF180</b>
SV650 A/SA K7-L0 (ABS)	07-10	<b>ARF196</b>
SV650 K3-K8	03-08	<b>ARF196</b>
SV650 S K3-L0	03-10	<b>ARF196</b>
GSR750 L1-L2	11-12	<b>ARF198</b>
GSX750 F K-6	89-06	<b>ARF170</b>
GSX-R750 W N-S	92-95	<b>ARF168</b>
GSX-R750 T-X SRAD	96-99	<b>ARF176</b>
GSX-R750 Y-K3	00-03	<b>ARF188</b>
GSX-R750 K4-K5	04-05	<b>ARF208</b>
GSX-R750 K6-L0	06-10	<b>ARF204</b>
DL1000 V-Strom / SE K2-L0	02-10	<b>ARF192</b>
GSX-R1000 K1-K4	01-04	<b>ARF188</b>
GSX-R1000 K5-K8	05-08	<b>ARF202</b>
SV1000/S K3-K7	03-07	<b>ARF196</b>
TL1000 R W-2	98-02	<b>ARF172</b>
TL1000 S V-Y	97-00	<b>ARF174</b>
GSX-R1100 W P-V	92-97	<b>ARF168</b>
GSF1200 / S Bandit	96-99	<b>ARF168</b>
GSF1200 S Y-K4 Bandit	00-04	<b>ARF184</b>
GSF1200 Y-K4 Bandit	00-04	<b>ARF184</b>
GSF1200 K5,K6 Bandit	05-06	<b>ARF206</b>
GSX1200	99-00	<b>ARF166</b>
GSX-R1300 R X-K7 Hayabusa	99-07	<b>ARF186</b>
GSX-R1300 RZ K2-K4 Hayabusa	02-04	<b>ARF186</b>
GSX1400 K1-K6	01-06	<b>ARF190</b>

### YAMAHA

125 Citycruiser	07-11	<b>ARF244</b>
125 Cityliner	07-11	<b>ARF244</b>
125 Skycruiser	06-11	<b>ARF244</b>
125 VINO	04-09	<b>ARF250</b>
125 XN Teo's	00	<b>ARF250</b>
125 XQ Maxster	01	<b>ARF250</b>
125 YP Majesty/E	98-11	<b>ARF250</b>
VP125 X-City	07-12	<b>ARF244</b>
XC125 Cygnus R	00-03	<b>ARF250</b>
XC125 T/K Cygnus R	95-03	<b>ARF210</b>
XC125V	06	<b>ARF250</b>
YJ125X	08	<b>ARF250</b>

Model	Year	Order Code
<b>YAMAHA cont...</b>		
YP125 R X-Max / Sport	06-12	<b>ARF244</b>
YP125 RA X-Max ABS	11-12	<b>ARF244</b>
YZF-R125	08-12	<b>ARF264</b>
150 XN Teo's	00	<b>ARF250</b>
150 XQ Maxster	01	<b>ARF250</b>
150 YP Majesty/E	98-11	<b>ARF250</b>
180 YP Majesty/E	98-11	<b>ARF250</b>
VP250 X-City	07-12	<b>ARF244</b>
YP250 R X-Max/Sport/ABS	05-12	<b>ARF244</b>
YP250 RA X-Max ABS	11-12	<b>ARF244</b>
YP400 Majesty (1st Filter)	04-12	<b>ARF232</b>
YP400 Majesty (2nd Filter)	04-12	<b>ARF234</b>
XP500 TMAX (Left Air Filter)	01-07	<b>ARF246</b>
XP500 TMAX ***	01-11	<b>ARF226</b>
FZS600 / SP Fazer	98-03	<b>ARF218</b>
FZ6 Fazer	04-06	<b>ARF240</b>
FZ6	07-10	<b>ARF240</b>
FZ6 Fazer / S2 (ABS)	07-09	<b>ARF240</b>
YZF-R6	99-02	<b>ARF220</b>
YZF-R6	08-10	<b>ARF266</b>
XVS650 all models	97-13	<b>ARF214</b>
FZ8 N / NA ABS	10-12	<b>ARF248</b>
FZ8 S,SA Fazer 8	10-12	<b>ARF248</b>
TDM850	91-01	<b>ARF212</b>
TDM900 / ABS	02-12	<b>ARF242</b>
XJ900 S/N Diversion	92-03	<b>ARF212</b>
FZS1000 Fazer	01-05	<b>ARF230</b>
FZ1 N / NA ABS	06-12	<b>ARF248</b>
FZ1 S Fazer / ABS	06-12	<b>ARF248</b>
YZF-R1	98-01	<b>ARF216</b>
YZF-R1	02-03	<b>ARF238</b>
BT1100 Bulldog	02-06	<b>ARF212</b>
XVS1100 all models	99-09	<b>ARF236</b>
VMX1200 (V-Max)	85-07	<b>ARF224</b>
XJR1200 / SP	95-98	<b>ARF222</b>
FJR1300 all models	01-12	<b>ARF228</b>
XJR1300 / SP	99-06	<b>ARF222</b>



MotorGP  
Exhausts  
Screens  
Commuter  
Controls  
Headlights  
Indicators  
Mirrors  
Rear  
Lights  
Lifts &  
Stands  
Tools  
Batteries &  
Chargers  
Electrics  
Chain  
Servicing  
Tyres &  
Tubes  
Security  
Bike  
Accs  
Luggage  
Rider  
Accs  
Tank  
Pads  
Extras

## Filtrex Performance Air Filters

FILTREX performance replacement air filter product guaranteed to increase horsepower and acceleration. Professionally engineered with a premium filtration material set within a high specification chassis, Filtrex will deliver increased performance and longevity over OEM and other aftermarket filters.

Filtrex air filters consist of four sheets of cotton gauze layered between two sheets of strong galvanized steel mesh coated with epoxy. This rigid construction guarantees against deformation under heat and powerful engine forces. Deep pleating of the filter material increases air filtration area and enhances speed of airflow, creating an overall high performing filter product.

Every filter is set within a frame produced from highly durable EPDM which is able to sustain extreme temperatures and still retain its form.

All Filtrex air filters are tested on state-of-the-art German made MAHA LPS3000 dynameters, specifically designed for motorcycle and vehicle purposes. Fully washable and reuseable

Filtrex air filters are available for the majority of the latest sports and street bikes  
ISO9001

Model	Year	Order Code
-------	------	------------

APRILIA		
RSV Mille Factory	04	<b>AIRA090</b>
RSV Mille R	04	<b>AIRA090</b>
RSV 1000R	05-12	<b>AIRA090</b>
RSV 1000R Factory	05-10	<b>AIRA090</b>
Tuono 1000R	06-10	<b>AIRA090</b>
Tuono 1000R Factory	06-10	<b>AIRA090</b>

BMW		
F650GS Dakar	09	<b>AIRB070</b>
F650GS	09-11	<b>AIRB070</b>
G650GS	09-11	<b>AIRB075</b>
F800	06-11	<b>AIRB070</b>
F800GS	10-11	<b>AIRB070</b>
F800R	09-10	<b>AIRB070</b>
R850R	95-03/06	<b>AIRB080</b>

S1000RR	09-10	<b>AIRB085</b>
R1100	93-01	<b>AIRB080</b>
R1100RT ABS	96-01	<b>AIRB080</b>
R1150	99-06	<b>AIRB080</b>
R1200GS Adventure	06-08/10	<b>AIRB070</b>
R1200	04-10	<b>AIRB070</b>
R1200R	07-11	<b>AIRB070</b>
R1200S	06-11	<b>AIRB070</b>
HP2 Enduro	06-07	<b>AIRB070</b>
HP2 Megamoto	07-11	<b>AIRB070</b>

CAGIVA		
Raptor 650	00-04	<b>AIRS027</b>
V Raptor 650	01-03	<b>AIRS027</b>

DUCATI		
Monster 620	02-06	<b>AIRD003</b>
Monster 620 Dark	01-06	<b>AIRD003</b>
Monster 695	07-08	<b>AIRD003</b>
Monster 696	08-12	<b>AIRD009</b>
Monster 800	03-04	<b>AIRD003</b>
Monster S2R 803	05-08	<b>AIRD003</b>
Monster S4 & S4R	01-07	<b>AIRD003</b>
848	08-10	<b>AIRD006</b>
Monster 1000S	03-05	<b>AIRD003</b>
1098	07-08	<b>AIRD006</b>
1098R	08-09	<b>AIRD006</b>
1098S / Tricolore	07-08	<b>AIRD006</b>
Monster 1100	09-10	<b>AIRD009</b>
Monster 1100S	09-10	<b>AIRD009</b>
Street Fighter 1100	09-11	<b>AIRD006</b>
Street Fighter S 1100	09-12	<b>AIRD006</b>
1198	09-11	<b>AIRD006</b>
1198S	09-11	<b>AIRD006</b>

Model	Year	Order Code
-------	------	------------

HONDA		
CBF500	04-06	<b>AIRH015</b>
CB600F Hornet	98-06	<b>AIRH015</b>
CB600F Hornet	07-09	<b>AIRH036</b>
CBF600 / S	04-06	<b>AIRH015</b>
CBF600 / S	07-12	<b>AIRH036</b>
CBR600 FX-FY	99-00	<b>AIRH018</b>
CBR600 F	01-06	<b>AIRH009</b>
CBR600 F Sport	01-02	<b>AIRH009</b>
CBR600RR	03-06	<b>AIRH012</b>
CBR600RR	07-12	<b>AIRH030</b>
VFR800	98-01	<b>AIRH032</b>
VFR800 VTEC	02-09	<b>AIRH032</b>
CB900F Hornet	02-07	<b>AIRH021</b>
CBR900RR Y-1 (929)	99-01	<b>AIRH024</b>
CBR900RR 2-3 (954)	02-03	<b>AIRH027</b>
CB1000R	08-10	<b>AIRH042</b>
CBR1000RR	04-07	<b>AIRH003</b>
CBR1000RR	08-12	<b>AIRH039</b>
VTR1000 SP1 / RC-51	00-06	<b>AIRH006</b>
VTR1000 SP2 RC-51	02-06	<b>AIRH006</b>

KAWASAKI		
ZX-6R G/J	98-02	<b>AIRK012</b>
ZX-6R (636) / ZX-6RR	03-04	<b>AIRK008</b>
ZX-6R (636) / ZX-6RR	05-06	<b>AIRK010</b>
ZX-6R	07-08	<b>AIRK016</b>
ZX-6R	09-12	<b>AIRK024</b>
Z750 / S	04-11	<b>AIRK002</b>
ZX-9R C/E/F	98-03	<b>AIRK014</b>
Z1000	03-09	<b>AIRK002</b>
Z1000	10-11	<b>AIRK036</b>
ZX-10R	04-07	<b>AIRK004</b>
ZX-10R	08-10	<b>AIRK020</b>
ZX-10R	11-12	<b>AIRK028</b>
ZRX1100	97-00	<b>AIRK040</b>
ZRX1200	01-09	<b>AIRK040</b>
GTR 1400	08-10	<b>AIRK032</b>
ZG1400 Concours	08-12	<b>AIRK032</b>
ZX14R Ninja	06-11	<b>AIRK032</b>
ZZR1400	06-11	<b>AIRK032</b>

SUZUKI		
GSF 650 Bandit	00-04	<b>AIRS042</b>
GSF 600 Bandit	05-10	<b>AIRS042</b>
GSX600F Katana	88-06	<b>AIRS030</b>
GSX-R600	97-00	<b>AIRS033</b>
GSX-R600 K1-K3	01-03	<b>AIRS018</b>
GSX-R600 K4-K5	04-05	<b>AIRS021</b>
GSX-R600 K6-L0	06-10	<b>AIRS024</b>
GSX-R600	11-12	<b>AIRS039</b>

Model	Year	Order Code
-------	------	------------

SUZUKI cont...		
GSX650F	08-09	<b>AIRS042</b>
SV650 / S	99-02	<b>AIRS027</b>
SV650 / S / SF	03-09	<b>AIRS015</b>
GSX750F Katana	89-06	<b>AIRS030</b>
GSX-R750	96-99	<b>AIRS033</b>
GSX-R750 Y-K3	00-03	<b>AIRS018</b>
GSX-R750 K4-K5	04-05	<b>AIRS021</b>
GSX-R750 K6-L0	06-10	<b>AIRS024</b>
GSX-R750	11-12	<b>AIRS039</b>
GSX-R1000 K1-K4	01-04	<b>AIRS018</b>
GSX-R1000 K5-K8	05-08	<b>AIRS003</b>
GSX-R1000 K9-L2	09-12	<b>AIRS036</b>
SV1000 / S	03-07	<b>AIRS015</b>
GSF 1200 Bandit	01-06	<b>AIRS042</b>
GSF 1250 Bandit	07-10	<b>AIRS042</b>
GSX1300R Hayabusa	99-07	<b>AIRS009</b>
GSX1300R Hayabusa	08-11	<b>AIRS006</b>
GSX1400	01-07	<b>AIRS012</b>

TRIUMPH		
Street Triple R 671	09-12	<b>AIRT005</b>
Street Triple 671	08-12	<b>AIRT005</b>
Daytona 675	06-12	<b>AIRT005</b>
Daytona 675 SE	08-09	<b>AIRT005</b>
Speed Triple 1050	05-10	<b>AIRT010</b>
Sprint ST 1050	05-10	<b>AIRT010</b>
Sprint GT 1050	11	<b>AIRT010</b>
Tiger	07-10	<b>AIRT010</b>

YAMAHA		
FZ6 / Fazer (all models)	04-09	<b>AIRY008</b>
FZ6R	09-11	<b>AIRY014</b>
XJ6 / Diversion	09-11	<b>AIRY014</b>
YZF-R6	99-05	<b>AIRY006</b>
YZF-R6S	06-09	<b>AIRY006</b>
YZF-R6	06-07	<b>AIRY010</b>
YZF-R6	08-12	<b>AIRY022</b>
TDM900A	07-09	<b>AIRY024</b>
TDM900	02-11	<b>AIRY024</b>
FZ1 / N / S	06-12	<b>AIRY012</b>
YZF-R1	02-03	<b>AIRY016</b>
YZF-R1 / LE / SP	04-06	<b>AIRY002</b>
YZF-R1	07-08	<b>AIRY018</b>
YZF-R1	09-12	<b>AIRY020</b>
FJR1300 (all models)	01-12	<b>AIRY004</b>



## Air Filter Care Service Kit

This service kit contains a pump spray filter cleaner and aerosol of service oil for use with Filtrix performance air filters. Filters should be serviced every 2000 miles to maintain optimum performance.

Order Code: **AIRKIT01**



## NGK Spark Plugs & Caps

A fully comprehensive range of spark plugs and plug caps from the market leader NGK.

### NGK IRIIDIUM SPARK PLUGS

Order Code	Type
SPKBR10EIX	BR10EIX (6668)
SPKBR8EIX	BR8EIX (5044)
SPKBR9EIX	BR9EIX (3981)
SPKCR8EHIX9	CR8EHIX-9 (3797)
SPKCR8EIX	CR8EIX (4218)
SPKCR9EHIX9	CR9EHIX-9 (6101)
SPKCR9EIX	CR9EIX (3521)
SPKDCR7EIX	DCR7EIX (3605)
SPKDCR9EIX	DCR9EIX (6650)

### NGK COPPER SPARK PLUGS

Order Code	Type
SPKB6ES	B6ES (7310)
SPKB6HS	B6HS (4510)
SPKB7ES	B7ES (1111)
SPKB7HS	B7HS (5110)
SPKB8ECS	B8ECS (2821)
SPKB8EG	B8EG (3430)
SPKB8ES	B8ES (2411)
SPKB8HS	B8HS (5492)
SPKB9EG	B9EG (3530)
SPKB9ES	B9ES (2611)
SPKB9HS	B9HS (5768)
SPKBKR7EKC	BKR7EKC (7354)
SPKBM6A	BM6A (5880)
SPKBP5ES	BP5ES (6511)
SPKBP6ES	BP6ES (7677)
SPKBP6HS	BP6HS (4511)
SPKBP7ES	BP7ES (2412)
SPKBP7HS	BP7HS (5111)
SPKBP8HS	BP8HS (2630)
SPKBPR4HS	BPR4HS (7823)
SPKBPR6HSA	BPR6HSA (4632)
SPKBR10EG	BR10EG (3830)
SPKBR7HS	BR7HS (4122)
SPKBR8EG	BR8EG (3130)
SPKBR8ES	BR8ES (5329)
SPKBR8HS	BR8HS (4322)
SPKBR8HSA	BR8HSA (5510)

### NGK COPPER SPARK PLUGS cont...

Order Code	Type
SPKBR9EG	BR9EG (3230)
SPKBR9ES	BR9ES (5664)
SPKBR9EYA	BR9EYA (7548)
SPKC7HSA	C7HSA (4629)
SPKCPR6EA9	CPR6EA9 (6899)
SPKCPR8EA9	CPR8EA9 (2306)
SPKCPR9EA9	CPR9EA9 (2308)
SPKCR10EK	CR10EK (2360)
SPKCR6HSA	CR6HSA (2983)
SPKCR7E	CR7E (4578)
SPKCR7EB	CR7EB (4663)
SPKCR7HS	CR7HS (6966)
SPKCR7HSA	CR7HSA (4549)
SPKCR8E	CR8E (1275)
SPKCR8EB	CR8EB (7784)
SPKCR8EH9	CR8EH-9 (5628)
SPKCR8EK	CR8EK (3478)
SPKCR9E	CR9E (6263)
SPKCR9EB	CR9EB (6955)
SPKCR9EH9	CR9EH-9 (7321)
SPKCR9EHI9	CR9EHI-9 (6314)
SPKCR9EIA9	CR9EIA-9 (6203)
SPKCR9EK	CR9EK (4548)
SPKD9EA	D9EA (2420)
SPKDCPR7E	DCPR7E (3932)
SPKDCPR8E	DCPR8E (4179)

### NGK COPPER SPARK PLUGS cont...

Order Code	Type
SPKDCPR9E	DCPR9E (2641)
SPKDPR7EA9	DPR7EA9 (5129)
SPKDPR8EA9	DPR8EA-9 (4929)
SPKDPR9EA9	DPR9EA-9 (5275)
SPKDR8EA	DR8EA (6955)
SPKDR8ES	DR8ES (5344)
SPKDR8ESL	DR8ES-L (2923)
SPKDR9EA	DR9EA (3437)
SPKIMR9C9H	IMR9C-9H (6650)
SPKIMR9C9HES	IMR9C-9HES (5766)
SPKIMR9E9HES	IMR9E-9HES (7556)
SPKJR9B	JR9B (3188)
SPKR6252K105	R6252K105 (2741)



### NGK SPARK PLUG COVERS

Order Code	Type	Description
SPKLB05EMH	LB05EMH (8338)	90 degree rubber sheathed (14mm)
SPKLB05F	LB05F (8051)	90 degree elbow type - resin (14mm)
SPKLD05F	LD05F (8060)	90 degree elbow type - resin (10-12mm)
SPKS05F	SB05F (8080)	Straight type - resin (14mm)
SPKSD05F	SD05F (8022)	Straight type - resin (10-12mm)
SPKVB05F	VB05F (8032)	120 degree elbow long type (14mm)
SPKVD05F	VD05F (8052)	120 degree elbow long type (10-12mm)
SPKXB05F	XB05F (8062)	102 degree elbow type (14mm)
SPKXD05F	XD05F (8072)	102 degree elbow type (10-12mm)

Motorc  
 Exhausts  
 Screens  
 Commuter  
 Controls  
 Headlights  
 Indicators  
 Mirrors  
 Rear  
 Lights  
 Lifts &  
 Stands  
 Tools  
 Batteries &  
 Chargers  
 Electrics  
 Chain  
 Servicing  
 Tyres &  
 Tubes  
 Security  
 Bike  
 Accs  
 Luggage  
 Rider  
 Accs  
 Tank  
 Pads  
 Extras

## Twin Shock Absorbers

Replacement twin shock absorbers covering the most popular models. Available in black or chrome options, supplied in pairs complete with bushes.



**TYPE 1**

335mm EYE/EYE FITTING  
**SHK01BLK** Black  
**SHK01CH** Chrome



**TYPE 2**

365mm EYE/EYE FITTING  
**SHK02BLK** Black  
**SHK02CH** Chrome



**TYPE 3**

335mm EYE/FORK FITTING  
**SHK03BLK** Black  
**SHK03CH** Chrome



**TYPE 4**

365mm EYE/FORK FITTING  
**SHK04BLK** Black  
**SHK04CH** Chrome



**TYPE 5**

325mm FORK/FORK FITTING  
**SHK05BLK** Black  
**SHK05CH** Chrome



**TYPE 6**

405mm EYE/EYE FITTING  
**SHK06BLK** Black



**TYPE 7A**

305mm EYE/EYE FITTING  
**SHK07ABLK** Black  
**SHK07ACH** Chrome



**TYPE 7**

325mm EYE/EYE FITTING  
**SHK07BLK** Black  
**SHK07CH** Chrome



**TYPE 8**

320mm EYE/EYE FITTING  
**SHK08BLK** Black  
**SHK08CH** Chrome



**TYPE 9**

320mm EYE/FORK FITTING  
**SHK09BLK** Black  
**SHK09CH** Chrome



**TYPE 10**

280mm EYE/EYE FITTING  
**SHK10BLK** Black  
**SHK10CH** Chrome



**TYPE 11**

255mm EYE/EYE FITTING  
**SHK11BLK** Black  
**SHK11CH** Chrome

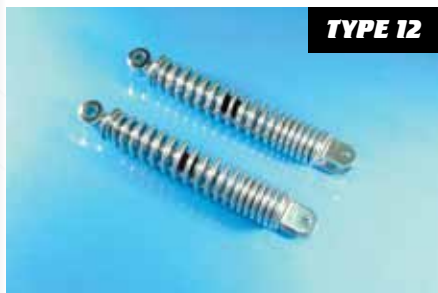

**TYPE 12**

245mm EYE/FORK FITTING  
**SHK12BLK** Black  
**SHK12CH** Chrome



**C90 CUB**

Fits Honda C90CUB  
 330mm EYE/EYE FITTING  
**SHKC90** Black

PLEASE NOTE: Shock absorber length is measured from centre to centre of mountings.

MotoGP  
 Exhausts  
 Screens  
 Commuter  
 Controls  
 Headlights  
 Indicators  
 Mirrors  
 Rear Lights  
 Lifts & Stands  
 Tools  
 Batteries & Chargers  
 Electrics  
 Chain  
 Servicing  
 Tyres & Tubes  
 Security  
 Bike Accs  
 Luggage  
 Rider Accs  
 Tank Pads  
 Extras  
 www.bikeit.co.uk



## Tubeless Scooter Tyres 10"-14"

A comprehensive range of tubeless scooter tyres available for the majority of today's scooters.

All tyres are fully E-mark compliant to ECE No.75, offering great grip and wear-rates.

Tyres supplied are Cougar brand wherever possible, if Cougar is not available Bike It will send an alternative brand of equivalent specification.

Order Code	Size	Tread	Fitment
<b>10"</b>			
TTL10350U	350-10	8302	F/R
TTL1013070	130/70-10	931	F/R
TTL1010080	100/80-10	926	F/R
TTL109090U	90/90-10	8001	F/R
TTL1010090	100/90-10	822	F/R
TTL1012070	120/70-10	931	F/R
TTL1012090	120/90-10	809	F/R
TTL1012090U	120/90-10	822	F/R
TTL1013090U	130/90-10	822	F/R
<b>11"</b>			
TTL1112070	120/70-11	806	F/R
<b>12"</b>			
TTL1212070	120/70-12	805/930/996	F/R
TTL1213070	130/70-12	805/930/996	F/R
TTL1214070	140/70-12	805/931	F/R
TTL1212080	120/80-12	805	F/R
TTL1211090	110/90-12	930	F/R
<b>13"</b>			
TTL1313060	130/60-13	805/931/ 930	F/R
TTL1314060	140/60-13	931/ 930	F/R
TTL1314060U	140/60-13	805	F/R
TTL1312070	120/70-13	806	F/R
TTL1313070	130/70-13	930	F/R
TTL1311090	110/90-13	806	F/R
<b>14"</b>			
TTL1412070	120/70-14	931/930	F/R
TTL1415070	150/70-14	820	F/R

### SPEED RATING REFERENCE

Ensure the correct rated tyres are used as per manufacturer recommendations.

Speed Index	Mph	Kmh
J	62	100
L	75	120
M	81	130
N	87	140
P	93	150
R	106	170
S	112	180
H	130	210

Tread pattern > **805**



Available in:  
120/80-12  
100/80-17  
120/70-12  
130/70-12  
140/70-12  
130/60-13  
140/60-13

SPEED INDEX  
**M-L**

Tread pattern > **806**



Available in:  
120/70-13  
110/90-13  
120/70-11

SPEED INDEX  
**P**

Tread pattern > **807**



Available in:  
90/90-10

SPEED INDEX  
**L**

Tread pattern > **809**



Available in:  
120/90-10

SPEED INDEX  
**L**

Tread pattern > **820**



Available in:  
150/70-14

SPEED INDEX  
**S**

Tread pattern > **822**



Available in:  
100/90-10  
120/90-10  
130/90-10

SPEED INDEX  
**L**

Tread pattern > **8302**



Available in:  
350-10

SPEED INDEX  
**J**

Tread pattern > **926**



Available in:  
100/80-10

SPEED INDEX  
**M**

Tread pattern > **996**



Available in:  
120/70-12  
130/70-12

SPEED INDEX  
**L**

Tread pattern > **931**

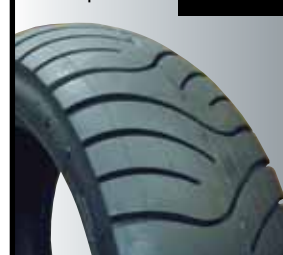

Available in:  
140/70-12  
130/60-13  
140/60-13  
120/70-10  
120/70-14  
130/70-10

SPEED INDEX  
**M**

Tread pattern > **930**



Available in:  
110/90-12  
120/70-14  
120/70-12  
130/70-12  
130/70-13  
130/60-13  
140/60-13

SPEED INDEX  
**M**

Tread pattern > **8001**



Available in:  
90/90-10

Motorcycle  
Exhausts  
Screens  
Commuter  
Controls  
Headlights  
Indicators  
Mirrors  
Rear Lights  
Lifts & Stands  
Tools  
Batteries & Chargers  
Electrics  
Chain  
Servicing  
Tyres & Tubes  
Security  
Bike Accs  
Luggage  
Rider Accs  
Tank Pads  
Extras

# Tube Type Road Tyres 8"-18"

Tube-type tyres for road bikes, offered in all popular sizes from 8" to 18".

All tyres are fully E-mark compliant to ECE No.75, offering great grip and wear-rates.

Tyres supplied are Cougar brand wherever possible, if Cougar is not available Bike It will send an alternative brand of equivalent specification.

Order Code	Size	Tread	Fitment
<b>8"</b>			
TTT8350L	350-8	871	F/R
TTT8350U	350-8	932	F/R
<b>10"</b>			
TTT10275G	275-10	929	F/R
TTT10300J	300-10	955	F/R
TTT10350C	350-10	894	F/R
TTT109090J	90/90-10	955	F/R
<b>16"</b>			
TTT16350A	350-16	876	R
<b>17"</b>			
TTT17225D	225-17	911	F/R
TTT17250M	250-17	861	F
TTT17250E	250-17	918	F/R
TTT17250K	250-17	874	F/R
TTT17275M	275-17	861	F
TTT17275F	275-17	201	F
TTT17275A	275-17	876	R
TTT17300P	300-17	722	F/R
TTT17300A	300-17	876	R
TTT17325A	325-17	876	R
<b>18"</b>			
TTT18250N	250-18	860	F
TTT18250E	250-18	918	F/R
TTT18250L	250-18	871	R
TTT18275N	275-18	860	F
TTT18275A	275-18	876	R
TTT18300A	300-18	876	R

## SPEED RATING REFERENCE

Ensure the correct rated tyres are used as per manufacturer recommendations.

Speed Index	Mph	Kmh
J	62	100
L	75	120
M	81	130
N	87	140
P	93	150
R	106	170
S	112	180
H	130	210

Tread pattern > **201**



Available in: 275-17

**SPEED INDEX P**

Tread pattern > **201**



Available in: 250-18

**SPEED INDEX L**

Tread pattern > **861**

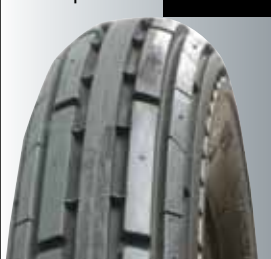

Available in: 275-17, 250-17

**SPEED INDEX N**

Tread pattern > **874**



Available in: 250-17

**SPEED INDEX N**

Tread pattern > **876**



Available in: 275-17, 275-18, 300-17, 300-18, 325-17, 350-16

**SPEED INDEX N**

Tread pattern > **894**

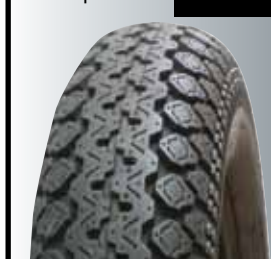

Available in: 350-10

**SPEED INDEX N**

Tread pattern > **911**



Available in: 225-17

**SPEED INDEX N**

Tread pattern > **918**

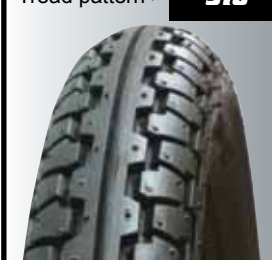

Available in: 250-18, 250-17

**SPEED INDEX N**

Tread pattern > **929**



Available in: 275-10

**SPEED INDEX N**

Tread pattern > **932**



Available in: 350-8

MotoGP  
Exhausts  
Screens  
Commuter  
Controls  
Headlights  
Indicators  
Mirrors  
Rear Lights  
Lifts & Stands  
Tools  
Batteries & Chargers  
Electrics  
Chain  
Servicing  
Tyres & Tubes  
Security  
Bike Accs  
Luggage  
Rider Accs  
Tank Pads  
Extras  
www.bikeit.co.uk



## Tube Type Road Tyres 8"-18" cont...

Tread pattern > **955**



Available in:  
90/90-10  
300-10

**SPEED INDEX**  
**N**

Tread pattern > **722**



Available in:  
300-17

**SPEED INDEX**  
**N**

Tread pattern > **860**

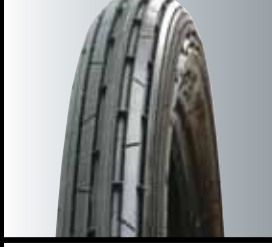

Available in:  
250-18  
275-18

**SPEED INDEX**  
**N**

Tread pattern > **871**



Available in:  
350-8  
250-18

**SPEED INDEX**  
**N**

## Tubeless Road Tyres 15"-19"

A comprehensive range of H-rated tubeless tyres, available in the most popular sizes for road bikes.

All tyres are fully E-mark compliant to ECE No.75, offering great grip and wear-rates.

Tyres supplied are Cougar brand wherever possible, if Cougar is not available Bike It will send an alternative brand of equivalent specification.

### SPEED RATING REFERENCE

*Ensure the correct rated tyres are used as per manufacturer recommendations.*

Speed Index	Mph	Kmh
J	62	100
L	75	120
M	81	130
N	87	140
P	93	150
R	106	170
S	112	180
H	130	210

Order Code	Size	Tread	Fitment
<b>15"</b>			
TTL1514090	140/90H-15	FT18R	R
<b>16"</b>			
TTL169090	90/90H-16	GPI2	F
TTL1611090	110/90H-16	GPI2	F
TTL1613090	130/90H-16	GPI1	R
<b>17"</b>			
TTL1711070	110/70H-17	GPI2	F
TTL1713070	130/70H-17	GPI1	R
TTL1710080	100/80-17	805	F/R
TTL1711080	110/80H-17	188	F/R
TTL1713090	130/90H-17	9107	F/R
<b>18"</b>			
TTL1810080	100/80H-18	188	F/R
TTL189090	90/90-18	126	F/R
TTL189090F	90/90H-18	GPI2	F
TTL1810090	100/90H-18	GPI1	R
TTL1811090	110/90H-18	GPI1	R
TTL1812090	120/90H-18	GPI1	R
<b>19"</b>			
TTL199090	90/90H-19	GPI2	F
TTL1910090	100/90H-19	GPI2	F

Tread pattern > **GPI1**



Available in:  
130/90H-16  
110/90H-18  
130/70H-17  
120/90H-18  
100/90H-18

**SPEED INDEX**  
**H**

Tread pattern > **GPI2**



Available in:  
90/90H-16  
90/90H-19  
90/90H-18  
110/70H-17  
100/90H-19  
110/90H-16

**SPEED INDEX**  
**H**

Tread pattern > **FT18R**



Available in:  
140/90-15

**SPEED INDEX**  
**H**

Tread pattern > **126**



Available in:  
90/90-18

**SPEED INDEX**  
**P**

Tread pattern > **188**



Available in:  
110/80H-17  
100/80H-18

**SPEED INDEX**  
**H**

Tread pattern > **805**



Available in:  
100/80-17

**SPEED INDEX**  
**M-L**

Tread pattern > **9107**

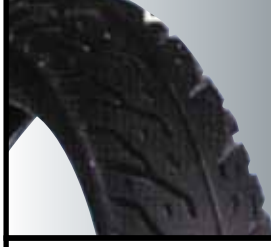

Available in:  
130/90H-17

**SPEED INDEX**  
**H**

Motocp  
Exhausts  
Screens  
Commuter  
Controls  
Headlights  
Indicators  
Mirrors  
Rear Lights  
Lifts & Stands  
Tools  
Batteries & Chargers  
Electrics  
Chain  
Servicing  
Tyres & Tubes  
Security  
Bike Accs  
Luggage  
Rider Accs  
Tank Pads  
Extras

## ATV Tyres

Order Code	Size	Tread	Fitment	E-marked	Ply
<b>6"</b>					
TTQ145706EU	145/70-6	810	F / R	Non E-marked	2
<b>7"</b>					
TTQ1687FU	16x8-7	808	F / R	E-marked	4
<b>8"</b>					
TTQ1978EU	19x7-8	810B	F / R	Non E-marked	4
TTQ2078DU	20x7-8	888	F / R	E-marked	4
TTQ22118FU	22x11-8	808	F / R	E-marked	4
<b>9"</b>					
TTQ20119HU	20x11-9	818	F / R	E-marked	4
<b>10"</b>					
TTQ21710GF	21x7-10	878B	Front	E-marked	4
<b>11"</b>					
TTQ24911JR	24x9-11	980	F / R	E-marked	4
<b>12"</b>					
TTQ24812JR	24x8-12	980	F / R	E-marked	4
TTQ251012AR	25x10-12	920	Rear	E-marked	4
TTQ25812AF	25x8-12	920	Front	E-marked	4
TTQ251012BR	25x10-12	968	Rear	E-marked	4
TTQ25812BF	25x8-12	968	Front	E-marked	4
TTQ251012CR	25x10-12	978	Rear	E-marked	4
TTQ25812CF	25x8-12	978	Front	E-marked	4

A comprehensive range of tubeless tyres to fit the most popular quads and ATVs.

A carefully selected range of tread patterns cater for all terrains and ground conditions, from tarmac to deep mud, ensuring optimum grip and handling.

All tyres are E-marked (except where indicated)

Tyres supplied are Cougar brand wherever possible – if Cougar is not available Bike It will send an alternative brand of equivalent specification.

Tread pattern > **808**



Available in:  
16x8-7  
22x11-8

Tread pattern > **810**



Available in:  
145/70-6  
19x7-8 - 810B

Tread pattern > **810B**



Available in:  
19x7-8

Tread pattern > **818**



Available in:  
20x11-9

Tread pattern > **878B**



Available in:  
21x7-10

Tread pattern > **888**



Available in:  
20x7-8

Tread pattern > **920**



Available in:  
25x10-12  
25x8-12

Tread pattern > **968**



Available in:  
25x10-12  
25x8-12

Tread pattern > **978**



Available in:  
25x10-12  
25x8-12

Tread pattern > **980**



Available in:  
24x8-12  
24x9-11



## Trial and Trail Tyres

Order Code	Size	Tread	Fitment
<b>18"</b>			
TTR18300	300-18	779*	
TTR18350B	350-18	889	
TTR18350	350-18	261	
TTR18400	400-18	889	
TTR18410B	410-18	889	
<b>21"</b>			
TTR21275H	275-21	933	
TTR21300	300-21	933	

Tube-type tyres suitable for trial and trail applications.

Fully E-mark compliant to ECE No.75 and therefore suitable also for road use (except \*).

Tyres supplied are Cougar brand wherever possible, if Cougar is not available Bike It will send an alternative brand of equivalent specification.

**FOR MX TYRES  
SEE OFF ROAD  
SECTION**

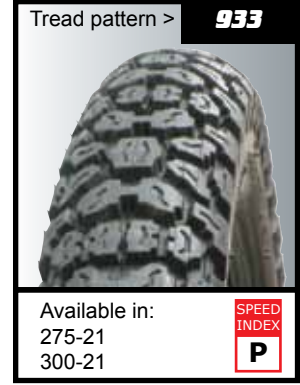
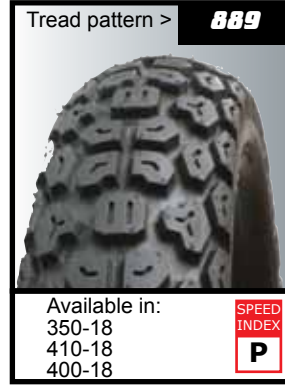
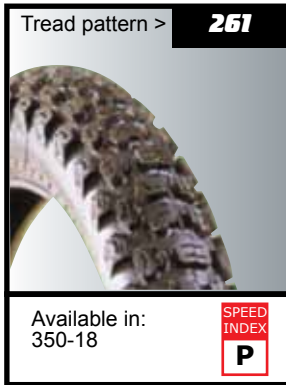

## Valve Caps

Multi-packs of the most widely used replacement valve caps. Available in black plastic and nickel plated ally. Sold in packs of 50pcs

Order Code	Description
VLV015	Black plastic (50pcs)
VLV020	Nickel plated (50pcs)

**NEW**



## Valve Extenders

Access to motorcycle tyre valves can be restricted when using some tyre inflators such as garage forecourt compressors. This selection of valve extenders simply screw onto the tyre valve allowing easier access for attaching air-chucks.

NB Remove immediately after tyre has been inflated – do not ride with extenders fitted.

Order Code	Description
VLVECH	90 degree, chrome plated
VLVEXT	Flexible braided hose



VLVECH



VLVEXT

## Tyre Valves

### METAL VALVES

Order Code	Description
VLV005	90 degree, Aluminium 11.3mm
VLV010	90 degree, Aluminium 8.3mm
VLV8CH	8mm Chrome plated T/L valve
VLV8GD	8mm Gold coloured T/L valve
VLV10CH	10mm Chrome plated T/L valve

VLV35GD	35mm height anodised gold T/L valve
VLV35BU	35mm height anodised blue T/L valve
VLV35R	35mm height anodised red T/L valve

### RUBBER VALVES

Order Code	Description
VLVDEG	90° right angle T/L valve

VLVR25	25mm height rubber T/L valve
VLVR42	42mm height rubber T/L valve
VLVR48	48mm height rubber T/L valve



ANODISED - VLV35..



Choose from blue, gold and red.



VLVDEG



VLV005 / 010

Motorcycle  
Exhausts  
Screens  
Commuter  
Controls  
Headlights  
Indicators  
Mirrors  
Rear Lights  
Lifts & Stands  
Tools  
Batteries & Chargers  
Electrics  
Chain  
Servicing  
Tyres & Tubes  
Security  
Bike Accs  
Luggage  
Rider Accs  
Tank Pads  
Extras

## Heavy Duty Butyl Inner Tubes

Premium quality motorcycle inner tubes. Manufactured from extra durable and hard-wearing butyl, providing excellent performance both on and off-road, featuring precision brass Schrader valve with dust cap.

Order Code	Valve	Size
<b>10"</b>		
ITB10250275	TR4/TR6	250/275-10
ITB10250275A	TR87	250/275-10
ITB10275300	TR4/TR6	275/300-10
ITB10275300A	TR87	275/300-10
ITB10350400A	TR87	350/400-10
ITB1010080A	TR87	100/80-10
<b>12"</b>		
ITB12300350	TR4/TR6	300/325/350-12
ITB1212070A	TR87	120(130)/70-12
<b>14"</b>		
ITB14225250	TR4/TR6	225/250-14
ITB14250275	TR4/TR6	250/275-14
ITB14350400	TR4/TR6	350/400-14
<b>15"</b>		
ITB15450510A	TR87	450/510-15
<b>16"</b>		
ITB16225250	TR4/TR6	225/250-16
ITB16250275	TR4/TR6	250/275-16
ITB16275300	TR4/TR6	275/300-16
ITB16300325	TR4/TR6	300/325-16
ITB16325350	TR4/TR6	325/350-16
ITB16350400	TR4/TR6	350/400-16
ITB16400450	TR4/TR6	400/450-16
ITB16450510	TR4/TR6	450/510-16

Order Code	Valve	Size
<b>17"</b>		
ITB17225250	TR4/TR6	225/250-17
ITB17275300	TR4/TR6	275/300-17
ITB17325350	TR4/TR6	325/350-17
ITB17350400	TR4/TR6	350/400-17
ITB17400450	TR4/TR6	400/450-17
ITB17450510	TR4/TR6	450/510-17
<b>18"</b>		
ITB18225250	TR4/TR6	225/250-18
ITB18250275	TR4/TR6	250/275-18
ITB18275300	TR4/TR6	275/300-18
ITB18300325	TR4/TR6	300/325-18
ITB18325350	TR4/TR6	325/350-18
ITB18350400	TR4/TR6	350/400-18
ITB18400450	TR4/TR6	400/450-18
ITB18450510	TR4/TR6	450/510-18
<b>19"</b>		
ITB19225250	TR4/TR6	225/250-19
ITB19275300	TR4/TR6	275/300-19
ITB19325400	TR4/TR6	325/350/400-19
ITB19400450	TR4/TR6	400/450-19
<b>21"</b>		
ITB21250300	TR4/TR6	250/275/300-21



## Adhesive Wheel Weights

50 x 60g strips (4x5g, 4x10g)  
Lead free, self adhesive.

Order Code Type  
WGT60 Silver  
WGT60BK Black



**50 Strips of 8 = 400 mixed weight pack**

## Heavy Duty Rim Tapes

Replacement heavy duty rim tapes available in all rim sizes, protects inner tubes from internal rim and spoke nipples. Available in standard width and extra wide 30mm suitable for road and off-road use.

**EXTRA WIDE 30mm**  
Order Code Rim  
RTPAA 17"  
RTPBB 18"  
RTPCC 19"



**STANDARD**  
Order Code Rim  
RTP10 10"  
RTP12 12"  
RTP14 14"  
RTP15 15"  
RTP16 16"  
RTP17 17"  
RTP18 18"  
RTP19 19"  
RTP21 21"



Motorcycle  
Exhausts  
Screens  
Commuter  
Controls  
Headlights  
Indicators  
Mirrors  
Rear Lights  
Lifts & Stands  
Tools  
Batteries & Chargers  
Electrics  
Chain  
Servicing  
Tyres & Tubes  
Security  
Bike Accs  
Luggage  
Rider Accs  
Tank Pads  
Extras  
www.bikeit.co.uk



## Valve Caps

Pairs of valve caps in chrome and anodised colours (blue, gold, green, purple, red, black & chrome)

<b>Order Code</b>	<b>Shape</b>
<b>VCPHEX</b>	Hexagon
<b>VCPSP1</b>	Small piston
<b>VCPRND</b>	Round
<b>VCPLPI</b>	Large piston

**VCPBULCH\*** Chrome bullet  
\*Available only in chrome

Dependant on what colour you would like please add one of the following after the code: BU (blue), GD (gold), GN (green), PU (purple), R (red), CH (chrome), BLK (black).



## Carbon Fibre Valve Caps

Premium quality valve cap, features chrome effect ends with a real carbon fibre sleeve.

Order Code:  
**VCPCBN13**

**NEW**



## Wheel & Bike Stripes

Biketek versatile tape rolls take wheel stripes one step further. The rolls of tape mould to the contour of the surface being adhered to, making easy and effective work on wheels. Each roll is long enough to cover both sides of 2 wheels. The tape can also be used on fairing panels and bodywork for colour coding with greater visibility and safety. The tapes will flawlessly follow curves and panel shapes, simply apply by hand.

<b>Order Code</b>	<b>Description</b>
<b>WST010</b>	7mm reflective light blue
<b>WST014</b>	7mm reflective white
<b>WST016</b>	7mm reflective dark blue
<b>WST018</b>	7mm reflective red
<b>WST020</b>	7mm reflective orange
<b>WST022</b>	7mm reflective green
<b>WST024</b>	7mm reflective black
<b>WST026</b>	7mm reflective gold

**WST5PC** 5 pack wheel/body stripes 7mm  
(Best selling mixed colours)



## CAPPA Dustcaps

Push-on / pull-off valve caps. Attaches to valve stem to prevent it being dropped or lost. Made from highly resistive thermoplastic rubber. Non-screw design makes pressure checks quick and easy. Watertight and airtight. Available in 9 colours

<b>Order Code</b>	<b>Description</b>
<b>CPP004</b>	Pink
<b>CPP006</b>	Black
<b>CPP008</b>	Red
<b>CPP010</b>	Silver
<b>CPP012</b>	Yellow
<b>CPP014</b>	Blue
<b>CPP016</b>	Green
<b>CPP018</b>	White
<b>CPP020</b>	Orange

**CPP002** 12 Pack



## Pressure Alert Valve Caps

Simple but effective valve caps that constantly monitor tyre pressure and alert you of pressure loss. Each cap has a minimum pressure rating, when tyre pressure is above the minimum a green ring shows - all OK. If pressure drops below the minimum rating, a red ring shows - time to inflate and check tyres.

Select the lowest PSI limit nearest to the bike manufacturer's recommended tyre pressure. 4 versions available, supplied individually.

<b>Order Code</b>	<b>PSI Limit</b>	<b>PSI Range</b>
<b>PSIAL2930</b>	28	29-30
<b>PSIAL3234</b>	30	32-34
<b>PSIAL3537</b>	34	35-37
<b>PSIAL4143</b>	40	41-43



## Tyre Pens

White indelible marker pens for enhancement of tyre side walls. Available in round and chisel nibs

<b>Order Code</b>	<b>Description</b>
<b>PENTYR11</b>	Round Nib
<b>PENTYR12</b>	Chisel Nib



Motorcycle  
Exhausts  
Screens  
Commuter  
Controls  
Headlights  
Indicators  
Mirrors  
Rear Lights  
Lifts & Stands  
Tools  
Batteries & Chargers  
Electrics  
Chain  
Servicing  
Tyres & Tubes  
Security  
Bike Accs  
Luggage  
Rider Accs  
Tank Pads  
Extras



# MAMMOTH



Utilising the best materials and components available, the Mammoth range provides security solutions for all motorcycle and scooter needs.

The Mammoth range includes:

Ground Anchors, Square & Hexagon section chains, Cable locks with and without integral U-lock options, Disc locks, U-locks and Lock reminders.

## GROUND ANCHORS

A lock and chain is only as good as the anchor point it is locked to. Ground anchors provide the perfect solution for this and are useable indoors & outdoors, in garages & driveways.

## EXTENSIONS & COILS

Extenders are useful for adding extra security by linking bikes together or to other objects. A reminder coil will stop any rider trying to pull away without removing a disc lock.

## LOCKS & CHAINS

Heavy duty chain & locks are a fantastic security option. Offering serious strength, locks and chains are an excellent visual deterrent also.

## DISC LOCKS & U-LOCKS

Provide a deterrent to thieves by making it increasingly difficult to wheel a bike away. Their small size and weight make them perfect security options when out & about.



[www.mammothsecurity.co.uk](http://www.mammothsecurity.co.uk)



## Mammoth Flip Ground Anchor

Unique design bolt-in ground anchor  
 Heavy-duty steel plate bolts into concrete surface  
 Suitable for indoor and outdoor use  
 Anchor loop folds flat when not in use  
 Neat plastic housing fits over anchor

Kit includes;  
 1 x Ground anchor unit  
 4 x Expander Allen Head Bolts  
 4 x Anti-Tamper Bearings  
 1 x Plastic housing cover

Order Code: **GRD007**

### Mammoth Rated



## Mammoth Lock & Chain

10mm square link hardened steel chain.  
 Hardened steel lock body with double bearing lock mechanism.  
 11mm hardened steel closed U-shackle.  
 Drill and pick resistant lock.  
 Bright green fabric sleeve acts as visual deterrent, protects wheels and paintwork.

### When to use:

Designed for all securing needs, especially suited to secure a motorbike to permanent fixing such as ground anchor, lamp post etc.

Order Code    Length  
**LOCM009**    1.8m

### Mammoth Rated



## Junior Bolt-In Ground Anchor

A security lock and chain is only as effective as the locking point it is secured to - thieves can easily remove a motorcycle if it is not secured to an anchor point.  
 The Mammoth Junior Bolt-In Ground Anchor provides a robust base to chain motorcycles to.

- Heavy-Duty ground anchor
- Simply bolts into concrete surface
- Manufactured from hardened steel
- Suitable for outdoor and indoor use

Order Code:  
**GRD005**



### Mammoth Rated



## Concrete-In Ground Anchor

- Heavy-Duty ground anchor
- Simply sink the anchor into new concrete
- Manufactured from hardened steel
- Rotating head section allows optimum access for chain and ease of use
- Suitable for outdoor and indoor use

Kit includes;  
 1 x Ground Anchor Unit  
 Instruction Guide

Order Code:  
**GRD003**



### Mammoth Rated



Motocp  
 Exhausts  
 Screens  
 Commuter  
 Controls  
 Headlights  
 Indicators  
 Mirrors  
 Rear Lights  
 Lifts & Stands  
 Tools  
 Batteries & Chargers  
 Electrics  
 Chain  
 Servicing  
 Tyres & Tubes  
**Security**  
 Bike Accs  
 Luggage  
 Rider Accs  
 Tank Pads  
 Extras

## Mammoth Lock & Chain

- 12mm square link Cr-Mo steel chain
- Available in 1.8m and 1.2m chain length.
- Hardened steel lock body with double bearing lock mechanism
- 11mm hardened Cr-Mo steel closed U-shackle
- Reinforced cylinder plates resist drilling and picking

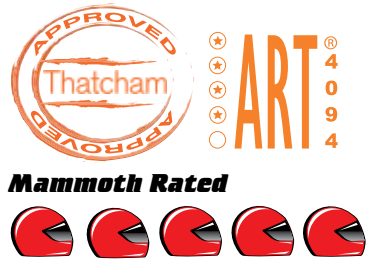

**When to use:**  
Designed for all securing needs, especially suited to secure a motorbike to a fixing such as ground anchor, lamp post etc.

Order Code	Length
LOCM003	1.8m
LOCM007	1.2m



This Mammoth security product has been evaluated against "The British Insurance Industry's Criteria for Vehicle Security", using specific tests to indicate the effectiveness of the product. It is recognised as a Thatcham 'Approved Device' Category 3 Mechanical Immobiliser. Thatcham Evaluation number TMC3-303-1207

## Mammoth Mini U-Disc Lock

- Hardened steel lock body
- 13mm extra hardened Cr-Mo steel U-shackle, with moulded covering
- Reinforced cylinder structure resists drilling and picking
- Designed for use as a disc lock

**When to use:**  
Intended as an additional or short-term security device. Disc locks are great for use when a lock and chain cannot be used, such as on journeys. Small and light enough to store in luggage or underseat, disc locks will make it more difficult for would be thieves to wheel a bike away. Use as additional security also whenever the bike is chained.  
Can also be used with a chain.

Order Code:  
LODM006



This Mammoth security product has been evaluated against "The British Insurance Industry's Criteria for Vehicle Security", using specific tests to indicate the effectiveness of the product. It is recognised as a Thatcham 'Approved Device' Category 3 Mechanical Immobiliser. Thatcham Evaluation number TMC3-305-1207

## Mammoth Shackle Disc Lock

- Hardened steel lock body with double bearing lock mechanism
- 11mm hardened Cr-Mo steel closed U-shackle
- Reinforced cylinder plates resist drilling and picking
- Extended length shackle and body for use as a disc lock

**When to use:**  
Intended as an additional or short-term security device. Disc locks are great for use when a lock and chain cannot be used, such as on journeys. Small and light enough to store in luggage or underseat, disc locks will make it more difficult for would be thieves to wheel a bike away. Use as additional security also whenever the bike is chained.

Can also be used with a chain.

Order Code:  
LODM002



This Mammoth security product has been evaluated against "The British Insurance Industry's Criteria for Vehicle Security", using specific tests to indicate the effectiveness of the product. It is recognised as a Thatcham 'Approved Device' Category 3 Mechanical Immobiliser. Thatcham Evaluation number TMC3-304-1207

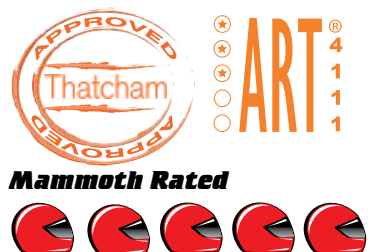



## Mammoth U-Lock

Premium quality U-Lock  
Extremely robust body for maximum theft deterency  
16mm hardened steel shackle with rubberised protective coating  
Double locking mechanism bar  
Weatherproof key cover  
125mm width (87mm internal) x 300mm length (internal)

### When to use:

Intended as an additional or short-term security device. U-Locks are ideal for use when a lock and chain cannot be used, such as on journeys when it is difficult to carry a heavy device – compact and light enough to store in panniers, tailbags and top-boxes. U-locks should be inserted through wheels, discs and forks, making it more difficult for would be thieves to wheel a bike away. Also use as additional security whenever the bike is chained to a permanent fixing.

Order Code: LOUM012

### Mammoth Rated



## Mammoth Disc Lock

Premium quality 10mm disc lock  
Extremely robust hardened steel body for maximum theft deterency  
10mm hardened steel pin

### When to use:

Intended as an additional or short-term security device. Disc locks are ideal for use when a lock and chain cannot be used, such as on journeys when it is difficult to carry a heavy device – compact and light enough to store in luggage or underseat. Disc locks should be inserted through brake discs making it more difficult for would be thieves to wheel a bike away. Also use as additional security whenever the bike is chained to a permanent fixing.

Order Code: LODM010

### Mammoth Rated



## Bolt-In Ground Anchor

- Heavy-Duty ground anchor
- Simply bolts into concrete surface
- Manufactured from hardened steel
- Twin layer design feature, increases protection
- Suitable for outdoor and indoor use

Kit includes;

- 1 x Ground Anchor Unit
- 4 x M10 Expander Allen Head Bolts
- 4 x Anti-Tamper Bearings
- Instruction Guide

Order Code: GRD001



### Mammoth Rated



This Mammoth security product has been evaluated against "The British Insurance Industry's Criteria for Vehicle Security", using specific tests to indicate the effectiveness of the product. It is recognised as a Thatcham 'Approved Device' Category 3 Mechanical Immobiliser. Thatcham Evaluation number TMC3-317-0310

Motocp  
Exhausts  
Screens  
Commuter  
Controls  
Headlights  
Indicators  
Mirrors  
Rear Lights  
Lifts & Stands  
Tools  
Batteries & Chargers  
Electrics  
Chain  
Servicing  
Tyres & Tubes  
Security  
Bike Accs  
Luggage  
Rider Accs  
Tank Pads  
Extras

## Mammoth Chain & Integral Lock

- 10mm square link hardened steel chain
- Integral reinforced lockhead
- Drill and pick resistant lock
- Bright green fabric sleeve acts as visual deterrent, protects wheels and paintwork

### When to use:

Designed for all securing needs, especially suited to secure a motorbike to permanent fixings such as ground anchors, lamp posts etc

Order Code Length  
**LOCM005** 1.65m



### Mammoth Rated



## 10mm Square Lock & Chain

- 10mm square section chain
- 1.8m length
- Protective textile outer sleeve protects paintwork and rims
- 11mm hardened steel closed shackle lock

Order Code: **LOCMAM**



### Mammoth Rated



## 12mm Hexagon Lock & Chain

Ultimate bike security! A large heavyweight chain and lock will deter a thief and give them a hard time if they try and take it on.

1 Meter Length  
 Order Code: **LOCMAMSS02**

- 12mm Hexagon section chain
- Available in 1m and 1.8m lengths
- Protective textile outer sleeve protects paintwork and rims
- 11mm hardened steel closed shackle lock

1.8 Meter Length  
 Order Code: **LOCMAMSS01**



### Mammoth Rated



## Shackle Lock

- Toughened casing
- 11mm hardened steel shackle lock
- Double ball bearing mechanism
- Hinged weatherproof barrel cover
- 62mm x 77mm (WxH)

Order Code: **LOCMAMSHK**



### Mammoth Rated



**This is the original product that has been repeatedly verified by UK security test houses as exceeding levels required by insurers**



## Mammoth Chain & Block Lock

- 10mm square link Cr-Mo chain
- Unique block style lock body with hardened steel shackle
- Drill and pick resistant lock
- Bright green fabric sleeve acts as visual deterrent, protects wheels and paintwork

### When to use:

Designed for all securing needs, especially suited to secure a motorbike to permanent fixings such as ground anchors, lamp posts etc

Order Code	Length
LOCM011	1.2m
LOCM015	1.8m

### Mammoth Rated



## Loop & 'U' Cable Lock

Cable locks offer the same functionality as lock and chains, but with the advantage that the lock head is integrated on the cable end. Use to lock motorcycles to ground anchors and other security points.

### INTEGRATED DISC LOCK

- Integrated mini U-lock allows disc lock function
- Fully rotating for ease of use
- Weatherproof barrel cover
- 14mm covered hardened steel shackle



### CABLE LOCK

- Woven hardened steel cable with protective outer sleeve (14mm)
- Outer sleeve protects paintwork and rims
- 1.6m cable
- Loop end allows 'noose' function for versatile locking options

Order Code: **LOCSU65**

### Mammoth Rated



## Lock & Chain

- 48" steel chain with protective cover.
- 8mm link.
- Laminated padlock with hardened steel pin.

Order Code Size  
LOCLCH Large 8mm



## Chain Storage Pouch

Robust nylon storage pouch for Mammoth lock and chains. Adjustable velcro straps fit securely under pillion seat for on-bike fitment.

Order Code: **LOCMAMP**



## Maxi Disc Locks

- 11mm hardened steel pin
- Tapered design for improved disc access
- Hinged barrel cover

Order Code: **LODMAX01** *Use as a disc lock or a shackle lock for chain!*



### Mammoth Rated



Motocp  
Exhausts  
Screens  
Commuter  
Controls  
Headlights  
Indicators  
Mirrors  
Rear Lights  
Lifts & Stands  
Tools  
Batteries & Chargers  
Electrics  
Chain  
Servicing  
Tyres & Tubes  
**Security**  
Bike Accs  
Luggage  
Rider Accs  
Tank Pads  
Extras

## Mammoth Alarm Disc Lock

- Robust motorcycle disc lock with integral motion-activated alarm.
- Suitable for motorcycles and scooters with disc brakes.

Order Code: **LODALM01**



**Mammoth Rated**



110 Decibel Alarm



## Blast Disc Locks

- Robust zinc alloy body
- Hardened Steel Pin in 10mm and 6mm options
- Weatherproof barrel cover
- Storage Pouch

Order Code    Pin Size  
**LOD10BLY**    10mm  
**LOD6BLY**     6mm



## Rotating Cover Disc Lock

- 95 x 95mm (W x H)
- 42 x 50mm (W x H) internal
- 14mm covered hardened steel shackle
- Double locking mechanism bar
- Rotating weatherproof lock cover

Order Code: **LODM**



## Grenade Disc Locks

- 10mm hardened steel pin
- Weatherproof barrel cover
- Carry storage pouch

Order Code    Colour  
**LOD10GRY**    Fluorescent Yellow  
**LOD10GRCH**   Chrome



**Mammoth Rated**



**Mammoth Rated**



## Heavy Duty Disc Lock

- 135 x 135mm (W x H)
- 57 x 93mm (W x H) internal
- 14mm vinyl covered hardened steel shackle
- Double locking mechanism bar

Order Code: **LODU**



## Zoid Disc Locks

- 6mm & 10mm pin sizes
- Hardened steel pin
- Weatherproof barrel cover
- Carry storage pouch

Order Code    Pin Size  
**LOD10ZDCH**   10mm pin  
**LOD6ZDCH**    6mm pin

**Mammoth Rated**



**Mammoth Rated**





## Original Disc Locks

- 6mm and 10mm pin options
- Hardened steel pin
- Carry storage pouch

Order Code Size

LOD6P 6mm original

LOD10P 10mm original

**Mammoth Rated**



LOD10P

LOD6P

## Micro Disc Lock

- 6mm pin
- Hardened steel pin

Order Code: **LOD6**



## Coil Cable Lock

A versatile and compact cable lock for securing motorcycles, cycles and kit

- 12mm woven steel cable
- 1.8m self-coiling cable
- Reinforced lockhead
- Anti-scratching PVC cable sheath
- Tubular mounting bracket

**Mammoth Rated**

Order Code:

LOCCBL12



## Snake Cable Locks

- Woven hardened steel cable reinforced with outer sleeve rollers
- Protective outer sleeve
- Reinforced lock head

Order Code Size

LOCB40 40"

LOCB48 48"

LOCB55 55"

LOCB65 65"

**Mammoth Rated**



## Combination Cable Lock

- Woven hardened steel cable (20mm) with protective sleeve
- Outer sleeve protects paintwork and rims
- 1.65m cable
- Selectable 5 digit combination lock (no keys to lose!)
- Robust reinforced lock head

Order Code:  
LOCCOM65



**Self-selecting 5 digit combination lock is built into reinforced lock head.**

**Mammoth Rated**



## Shackle U-Lock

Designed to lock through the front discs or wheel, this robust shackle U-lock prevents a bike being wheeled away.

- Hardened steel shackle
- Anti-scratching shackle covering
- Double locking bar mechanism
- Weatherproof barrel protector
- 160mm width x 320mm length

Order Code: **LOUM011**



**Mammoth Rated**



## Disc Lock Reminder

Bikers do forget to remove a disc lock before riding away - the results are costly and embarrassing! A Disc Lock Reminder simply attaches between the brake lever and disc lock, offering a visual reminder to remove the lock. Also offers a visual deterrent to would-be thieves.

Order Code: **LODCOIL**



**Prevents riding away with disc lock attached!**

## X-Line Cable

The X-Line is a versatile cable that should be used with other security products as an extender or to loop around anchor points. USE WITH SHACKLE LOCKS, PADLOCKS and U-LOCKS

- Reinforced steel cable with protective sleeve (6mm)
- Outer sleeve protects paintwork and rims
- 1.8m recoiling cable
- Looped ends

**Mammoth Rated**



Order Code:

LOCXLIN



**Use as an extension cable with other security products including U-locks, cable locks and lock and chain.**



Shown used in conjunction with U-lock.

Motorcyc

Exhausts

Screens

Commuter

Controls

Headlights

Indicators

Mirrors

Rear Lights

Lifts & Stands

Tools

Batteries & Chargers

Electrics

Chain

Servicing

Tyres & Tubes

Security

Bike Accs

Luggage

Rider Accs

Tank Pads

Extras

## 12V Motorcycle Alarm - Basic

Biketek alarm suitable for all 12v motorcycles, scooters and ATVs

- Self-install unit with just 2 wires, connecting to battery terminals
- Includes self-adhesive mounting pads
- 125dB piercing dual-tone siren
- Weatherproof sensor module and siren
- Compact sensor module, activated when vehicle is moved
- Includes 1 controller keyfob

Order Code:  
**ALAREM12**



## 12V Motorcycle Alarm - Full Model

Biketek alarm suitable for all 12v motorcycles, scooters and ATVs

- Self-install unit with just 9 wires, connecting to battery terminals, indicators
- Includes self-adhesive mounting pads
- 125dB piercing dual-tone siren
- Waterproof sensor module and siren
- Compact sensor module, activated when vehicle is moved
- Arming reminder
- Vehicle finder function
- Includes 2 controller keyfobs
- 100 meter range

Order Code:  
**ALAREM14**



## Garage Guard

- Remote PIR Alarm
- Keypad controlled alarm
- Activates when movement detected
- 2 Keyfob Remote Controls
- Entry / Exit delays
- Piercing 105dB alarm sound
- Wall mounted OR Stand alone
- Battery Operated

Order Code: **ALAGRG01**



Battery operated motion sensor alarm, perfect for use in garages or sheds.

## Multi-Purpose Alarm

Any thief will think twice about trying to steal a bike once an alarm is triggered – drawing attention to the situation, a thief cannot hang around.

This simple alarm offers great effectiveness at a minimal cost. Battery operated, the alarm requires little installation, just fix the alarm to the bike with the adhesive pads or fitting bracket supplied, no wiring is necessary. A key barrel activates the alarm, any movement of the bike thereafter will trigger the piercing alarm which will continue to sound until the bike is left stationary or until the key deactivates it.

Ideal also for garage doors, internal doors, windows, jet ski's etc. Requires 1 x 9v battery (PP3/PP7/6LR6) (not supplied).

- Battery Operated
- Easy installation – no wiring
- Use on any moveable items

Order Code: **ALAMUL**



## Helmet & Clothing Locks

LID-LOK is excellent for securing helmets and clothing to bikes or other anchor points.

- Reinforced steel cable with protective sleeve (6mm)
- 1.65m self coiling cable
- Reinforced lock head

Order Code: **LOCLID**

### Mammoth Rated



## Handlebar Helmet Lock

The universal helmet lock comprises of a locking bar unit that clamps onto round tubing such as handlebars. When fitted, a helmet can be locked to the unit by the double D-Ring of the neck strap.

Order Code: **LOCHELM**





## Standard Tyre Warmers

Bike Tek tyre warmers are available for every bike application and user budget. Whether for serious superbike, supermoto or 125cc racing, or for track day fun, Bike Tek offer a tyre heating solution to make the most of tyre performance and enhance track time.

This model of warmer offers easy and efficient tyre warming. Every warmer is thermostatically controlled with dual LED indicators which illuminate RED when the warmer is heating, switching to GREEN when full temperature (80°C) is reached. The heating element design ensures optimum heat coverage across the tyre, fully insulated to retain the generated warmth.

The warmers are secured by sturdy velcro fasteners, the contoured shape and elasticated sides aiding simple and effortless fitting.

Supplied with drawstring storage bag.

Bike Tek tyre warmers have been developed with and used by BSB teams and will again be in use in the 2013 BSB season.

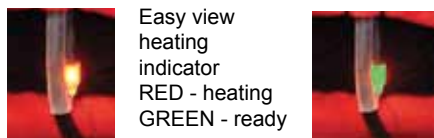

Easy view heating indicator  
RED - heating  
GREEN - ready



As used in the British Superbike Championship



## BikeTek Tyre & Wheel Bag

Heavy-duty transit and storage bag for motorcycle tyres and wheels. Protects all types of tyres. Suitable for tyre sizes 16"-21". Made from robust oxford material. Features handle for carrying and hanging. PVC window for name / team tags. Elasticated seams with velcro closure.

Order Code: **TYRB01**



Order Code	Bike	Front tyre	Rear tyre	Plug
TYRW07	125cc	90/70-17	125/55-17	3 pin UK
TYRW09	250cc / Supermoto	120/70-17	160>	3 pin UK
TYRW11	Superbikes	120/70-17	180>	3 pin UK
TYRW11E	Superbikes	120/70-17	180>	2 pin Euro
TYRW23		120/70-17	200/55-17	3 pin UK
TYRW23E		120/70-17	200/55-17	2 pin Euro

All Bike It warmers offer 1 year warranty from date of purchase

## Professional Digital Tyre Warmers

Enjoying the same heating element design and insulation as the standard warmers, Bike Tek Professional Digital warmers use a digital display micro-processor temperature controller offering adjustable heating. Depending on weather conditions, the greater control of the professional warmers allows precise heating through a range from 40-99 °C, with the benefit of real time temperature readouts. The temperature controller is located in a central module, so both front and rear warmers can be controlled and viewed simultaneously.

Order Code	Bike	Front tyre	Rear tyre
TYRW19	Superbikes	120/70-17	180 >



As used in the British Superbike Championship



All Bike It warmers offer 1 year warranty from date of purchase.

Motorcycle  
Exhausts  
Screens  
Commuter  
Controls  
Headlights  
Indicators  
Mirrors  
Rear Lights  
Lifts & Stands  
Tools  
Batteries & Chargers  
Electrics  
Chain  
Servicing  
Tyres & Tubes  
Security  
Bike Accs  
Luggage  
Rider Accs  
Tank Pads  
Extras

## Titax Front Fork Adjusters

Model	Year	Black	Gold	Blue	Silver
<b>APRILIA</b>					
RSV 1000 with Ohlins		AFBK017	AFG017	AFBL017	AFS017
RSV 1000 with Showa		AFBK022	AFG022	AFBL022	AFS022
<b>DUCATI</b>					
All Models with Ohlins		AFBK017	AFG017	AFBL017	AFS017
All Models with Showa		AFBK022	AFG022	AFBL022	AFS022
<b>HONDA</b>					
RVF 400	/	AFBK022	AFG022	AFBL022	AFS022
CBR 600 F/S	91'-12'	AFBK145	AFG145	AFBL145	AFS145
CBR 600 RR	03'-04'	AFBK145	AFG145	AFBL145	AFS145
CBR 600 RR	05'-06'	AFBK022	AFG022	AFBL022	AFS022
CBR 600 RR	07'-12'	AFBK019	AFG019	AFBL019	AFS019
CBR 900 RR	92'-99'	AFBK145	AFG145	AFBL145	AFS145
CBR 900 RR	00'-03'	AFBK022	AFG022	AFBL022	AFS022
CB 1000 R	08'-12'	AFBK019	AFG019	AFBL019	AFS019
CBR 1000 RR	04'-07'	AFBK022	AFG022	AFBL022	AFS022
CBR 1000 RR	08'-12'	AFBK019	AFG019	AFBL019	AFS019
VTR 1000 F	00'-07'	AFBK145	AFG145	AFBL145	AFS145
VTR 1000 SP1/2	00'-07'	AFBK022	AFG022	AFBL022	AFS022
<b>KAWASAKI</b>					
ZXR 400	90'-02'	AFBK022	AFG022	AFBL022	AFS022
ZX 6R	98'-04'	AFBK017	AFG017	AFBL017	AFS017
ZX 6R/RR	05'-06'	AFBK022	AFG022	AFBL022	AFS022
ZX 6R	07'-08'	AFBK019	AFG019	AFBL019	AFS019
Z 750	07'-12'	AFBK014	AFG014	AFBL014	AFS014
ZX 9R	98'-03'	AFBK017	AFG017	AFBL017	AFS017
Z 1000	03'-06'	AFBK022	AFG022	AFBL022	AFS022
Z 1000	07'-09'	AFBK019	AFG019	AFBL019	AFS019
ZX 10R	04'-12'	AFBK014	AFG014	AFBL014	AFS014
ZX 12R	00'-06'	AFBK017	AFG017	AFBL017	AFS017
ZZR 1400	08'-12'	AFBK014	AFG014	AFBL014	AFS014
<b>MV AGUSTA</b>					
BRUTALE	ALL	AFBK019	AFG019	AFBL019	AFS019
F4 750/1000	99'-12'	AFBK019	AFG019	AFBL019	AFS019
<b>SUZUKI</b>					
GSX-R 600	97'-03'	AFBK145	AFG145	AFBL145	AFS145
GSX-R 600	04'-05'	AFBK022	AFG022	AFBL022	AFS022
GSX-R 600	06'-12'	AFBK019	AFG019	AFBL019	AFS019
GSX-R 750	92'-03'	AFBK022	AFG022	AFBL022	AFS022
GSX-R 750	04'-05'	AFBK022	AFG022	AFBL022	AFS022
GSX-R 750	06'-12'	AFBK019	AFG019	AFBL019	AFS019
GSX-R 1000	01'-08'	AFBK014	AFG014	AFBL014	AFS014
SV 1000 / S	03'-05'	AFBK014	AFG014	AFBL014	AFS014
TL 1000 S/R	97'-02'	AFBK017	AFG017	AFBL017	AFS017
GSX-R 1100	95'-98'	AFBK017	AFG017	AFBL017	AFS017
B-KING	08'-12'	AFBK014	AFG014	AFBL014	AFS014
<b>TRIUMPH</b>					
DAYTONA 675	06'-12'	AFBK014	AFG014	AFBL014	AFS014
STREET TRIPLE 675	07'-12'	AFBK014	AFG014	AFBL014	AFS014
DAYTONA 955 ie	99'-02'	AFBK145	AFG145	AFBL145	AFS145
SPEED TRIPLE 955 ie	00'-04'	AFBK145	AFG145	AFBL145	AFS145
SPEED TRIPLE 1050	05'-12'	AFBK022	AFG022	AFBL022	AFS022
<b>YAMAHA</b>					
YZF 600	96'-02'	AFBK017	AFG017	AFBL017	AFS017
YZF-R6	99'-05'	AFBK017	AFG017	AFBL017	AFS017
YZF-R6	06'-07'	AFBK017	AFG017	AFBL017	AFS017
YZF-R6	08'-12'	AFBK014	AFG014	AFBL014	AFS014
YZF 750 R/SP	93'-98'	AFBK017	AFG017	AFBL017	AFS017
FAZER 1000	00'-05'	AFBK017	AFG017	AFBL017	AFS017
FZ1 N / FAZER	06'-12'	AFBK014	AFG014	AFBL014	AFS014
FZR 1000	91'-95'	AFBK017	AFG017	AFBL017	AFS017
YZF 1000	96'-02'	AFBK017	AFG017	AFBL017	AFS017
YZF-R1	98'-03'	AFBK014	AFG014	AFBL014	AFS014
YZF-R1	04'-12'	AFBK014	AFG014	AFBL014	AFS014



**FRONT FORK ADJUSTERS**  
As usually TITAX comes with enhancements and following features, namely:

- HIGHTENED GRIP for the fingers!
- Exclusively by TITAX!
- EASY FINGERS WORK even in GLOVES!
- LASER designation.
- HIGH TECH design.
- 4 colors - colors fits to levers.
- Design fits to TITAX Steering damper and TITAX Levers.



RACING PRODUCT  
**FRONT FORK ADJUSTERS**



[www.TITAX.COM](http://www.TITAX.COM)

MotoGP  
 Exhausts  
 Screens  
 Commuter  
 Controls  
 Headlights  
 Indicators  
 Mirrors  
 Rear Lights  
 Lifts & Stands  
 Tools  
 Batteries & Chargers  
 Electrics  
 Chain  
 Servicing  
 Tyres & Tubes  
 Security  
 Bike Locks  
 Luggage  
 Rider Accs  
 Tank Pads  
 Extras  
[www.bikeit.co.uk](http://www.bikeit.co.uk)



## Titax Steering Dampers

1) Choose your steering damper body and adjuster colour...



Order	Description
TTXVBK	BLACK BODY WITH GOLD ADJUSTER
TTXVBL	BLUE BODY WITH GOLD ADJUSTER
TTXVVG	GOLD BODY WITH BLACK ADJUSTER

2) Add your bike specific adaptor kit...

Model	Year	Order Code	Model	Year	Order Code	Model	Year	Order Code
<b>DUCATI</b>			<b>KAWASAKI</b>			<b>SUZUKI cont..</b>		
MONSTER 696	09-11	TTXV139A	Ninja 250R	08-09	TTXV143A	GSX-R1000	09-11	TTXV138A
MONSTER 796	09-11	TTXV141A	ER 6 N	09-11	TTXV144A	Hayabusa	98-12	TTXV114A
MONSTER 1100S	09-11	TTXV141A	ZX6R	09-10	TTXV140A	<b>TRIUMPH</b>		
HYPERMOTARD 1100	09-11	TTXV141A	Z 750	08-11	TTXV136A	Daytona 675 / 675R	09-11	TTXV120A
<b>HONDA</b>			<b>SUZUKI</b>			<b>YAMAHA</b>		
CB 1000R	08-10	TTXV131A	GSX-R600	06-07	TTXV108A	R6	06-07	TTXV133A
			GSX-R600/750	08-10	TTXV128A	R6	08-11	TTXV146A
			GSX-R750	06-07	TTXV109A	FZ 6	07-10	TTXV150A
			GSX-R1000	05-06	TTXV111A			
			GSX-R1000	08	TTXV132A			

## Titax Mirror Blocks

Model	Year	Titanium	Black	Gold	Red	Blue	Green
<b>HONDA</b>							
CBR 600 RR	09-12	MCT100	MCBK100	MCG100	MCR100		
CBR 1000 RR	08-12	MCT101	MCBK101	MCG101	MCR101		
<b>KAWASAKI</b>							
ZX6-R	09-12	MCT120	MCBK120	MCG120			MCGN120
ZX10-R	08-09	MCT121	MCBK121	MCG121			MCGN121
<b>SUZUKI</b>							
GSXR 600	05-12	MCT160	MCBK160	MCG160			MCBL160
GSXR 750	05-12	MCT160	MCBK160	MCG160			MCBL160
GSXR 1000	05-12	MCT160	MCBK160	MCG160			MCBL160
<b>YAMAHA</b>							
R6	08-09	MCT180	MCBK180	MCG180	MCR180		MCBL180
R1	09-12	MCT181	MCBK181	MCG181	MCR181		MCBL181

Beautifully crafted CNC aluminium mirror blocks. Bolts directly into the OEM mirror mount. Allows removal of mirrors for track use.



## Titax Bar-Ends

Size	Titanium Colour	Chrome Colour	Black Colour	Gold Colour	Red Colour	Blue Colour
14mm diameter	HCT014	HCS014	HCBK014	HCG014	HCR014	HCBL014
17mm diameter	HCT017	HCS017	HCBK017	HCG017	HCR017	HCBL017

CNC machined aluminium bar-ends. Available in 14mm and 17mm fitment. Wide range of colours to match other Titax product.



## Titax Bobbin Spools

Bolt	Titanium Colour	Chrome Colour	Black Colour	Gold Colour	Red Colour	Blue Colour
6mm	SBT006	SBS006	SBBK006	SBG006	SBR006	SBBL006
8mm	SBT008	SBS008	SBBK008	SBG008	SBR008	SBBL008
10mm (1.25 pitch)	SBT125	SBS125	SBBK125	SBG125	SBR125	SBBL125
10mm (1.5 pitch)	SBT150	SBS150	SBBK150	SBG150	SBR150	SBBL150

CNC machined bobbin spools. Allows motorcycle to be lifted on paddock stand. Available in 6mm, 8mm and 10mm fitment. Wide range of colours to match other Titax product.



Motocp  
Exhausts  
Screens  
Commuter  
Controls  
Headlights  
Indicators  
Mirrors  
Rear Lights  
Lifts & Stands  
Tools  
Batteries & Chargers  
Electrics  
Chain  
Servicing  
Tyres & Tubes  
Security  
Bike Accs  
Luggage  
Rider Accs  
Tank Pads  
Extras

## BikeTek Crash Protectors

Crash protectors fit to engine frames and provide a ground contact point in the event of a crash. With the impact concentrated through the protector, bike and fairing contact is reduced and can minimise crash damage. Biketek offer a full range of protectors, with mounting kits where required. The protectors are a highly durable non-shatter material with low friction upon contact – the ideal properties for crash protectors. Some models will require the fairing to be modified and cut to allow installation of the adaptors, these are detailed in the below application list.



# BIKETEK



## Crash Protectors - T6 Aluminium & Carbon-Fibre

Aluminium and carbon-fibre sleeved crash protectors, offer all the advantages of STP polymer protectors, but with a different look – high polished aluminium and carbon-fibre. Complete with mounting kits where required. Some models will require the fairing to be modified and cut to allow installation of the adaptors, these are detailed in the below application list.

MODEL	Year	Fairing Mod Required?	T6 Aluminium	Carbon Fibre
-------	------	-----------------------	--------------	--------------

HONDA				
CBR600 FX-FY	99-00	YES	8503200	9503209
CBR600 F/Fi FS1/2	01-06	YES	8503200	9503209
CBR900RR Y/1	00-01	NO	8503500	9503509
CBR900RR 2/3	02-03	NO	8503500	9503509
CBR1000RR	06-07	NO	#	9503819
VTR1000 SP2 (RC51)	02-06	YES	8503700	#

KAWASAKI				
ZX6R/RR/9R/12R (STREET)	98-04	NO	#	#
ZX6R/RR (RACE)	03-04	NO	8504200	9504209
ZX6R/RR	05-06	YES	8504400	9504409
ZX6R/RR	07-08	NO	8504410	9504410
ZX7R	96-03	YES	8504300	#
ZX9R (RACE)	02-03	NO	8504500	#
Z1000	03-06	NO	8504800	9504809
ZX10R	04-05	NO	8504900	9504909
ZX10R	06-07	NO	8504910	9504919
ZX14R	06-08	NO	8504709	#

SUZUKI				
GSXR600 V-Y	97-00	NO	8505100	#
GSXR600 K1-K3 (STREET)	01-03	NO	8505200	#
GSXR600 K4-K5	04-05	NO	8505400	9505409
GSXR600 K6-K9	06-09	NO	8505410	#
GSXR600 K6-K9	06-09	YES	8505420	#
SV650 (NOT S MODEL)	99-02	NO	8505500	9505509

MODEL	Year	Fairing Mod Required?	T6 Aluminium	Carbon Fibre
-------	------	-----------------------	--------------	--------------

SUZUKI cont...				
GSXR750 T-X	96-99	NO	8505100	#
GSXR750 Y-K3	00-03	NO	8505200	#
GSXR750 K4-K5	04-05	NO	8505400	9505409
GSXR750 K6-K9	06-09	NO	8505410	#
GSXR750 K6-K9	06-09	YES	8505420	#
GSXR1000 K1-K2	01-02	NO	8505700	#
GSXR1000 K3-K4	03-04	NO	8505800	9505809
GSXR1000 K5-K6	05-06	NO	8505300	9505309
GSXR1000 K7-K8	07-08	NO	8505310	9505310
SV1000	03-07	NO	#	9505909
GSXR1300 H'BUSA	99-07	YES	8505210	#

YAMAHA				
FZ6	04-08	NO	8506310	#
YZF-R6	98-02	YES	8506200	#
YZF-R6	03-06	NO	8506300	#
YZF-R6 (RACE)	03-06	YES	8506210	#
YZF-R6	06-07	NO	8506320	#
YZF-R1	98-99	YES	8506400	#
YZF-R1	98-99	NO	8506500	#
YZF-R1	00-01	YES	8506900	9506909
YZF-R1	02-03	NO	8506110	9506119
YZF-R1	04-06	NO	8506700	#
YZF-R1	07-08	NO	8506710	#
CLUTCH SLIDER	98-05	NO	8506600	#
YZF-R6				
CLUTCH SLIDER	98-06	NO	8506600	#
YZF-R1				

\* Crash protectors for bikes marked YES to 'Fairing Mod Required?' require alterations and cutting of the fairing.

## Crash Protectors End Caps

Biketek carbon fibre frame sliders can be upgraded with these fantastic aluminium coloured end caps. Each kit consists of a pair of end caps and allen bolts for easy and direct replacement of originals. Perfect for colour coding or replacements after bike has been dropped.

Order Code	Colour
FSL001	Black
FSL002	Blue
FSL003	Gold
FSL004	Red
FSL005	Alloy



MotoGP  
 Exhausts  
 Screens  
 Commuter  
 Controls  
 Headlights  
 Indicators  
 Mirrors  
 Rear Lights  
 Lifts & Stands  
 Tools  
 Batteries & Chargers  
 Electrics  
 Chain  
 Servicing  
 Tyres & Tubes  
 Security  
 Bike Locks  
 Luggage  
 Rider Accs  
 Tank Pads  
 Extras  
 www.biketek.co.uk



## Crash Protectors - STP Polymer

Crash protectors fit to engine frames and provide a ground contact point in the event of a crash. With the impact concentrated through the protector, bike and fairing contact is reduced and can minimise crash damage. Biketek offer a full range of protectors, with mounting kits where required. The protectors are manufactured from STP polymer, a highly durable non-shatter material with low friction upon contact – the ideal properties for crash protectors. Some models will require the fairing to be modified and cut to allow installation of the adaptors, these are detailed in the below application list.

MODEL	Year	Fairing Mod Required?	BLACK STP
<b>APRILIA</b>			
RSVR / FACTORY	04-07	NO	7509309
TUONO	06>	NO	7509309
RSV4	ALL	NO	7509010
<b>DUCATI</b>			
Monster 696	08>	NO	7509170
MONSTER	>00	NO	7509139
MONSTER	01>	NO	7509119
848	ALL	YES	7509159
1098/S	ALL	YES	7509159
Monster 1100S	09>	NO	7509170
1100 Hypermotard	ALL	NO	7509120
<b>BMW</b>			
F800R	10-11	NO	7509580
S1000RR	10>	NO	7507730
K1200R	ALL	NO	7509409
K1300R	10>	NO	7509520
<b>HONDA</b>			
CBR250R	11>	NO	7503970
CB600 HORNET	>06	NO	7503929
CBF600	04-07	NO	7503929
CB600 HORNET	07-08	NO	7503919
CBF600	08>	NO	7503919
CBR600 FM-FW	91-98	YES	7503109
CBR600 FX-FY	99-00	YES	7503209
CBR600 F/FI FS1/2	01-06	YES	7503209
CBR600RR	03-06	YES	7503309
CBR600RR	07-08	NO	7503319
CBR600RR	07-08	YES	7503329
CBR600RR	09>	YES	7503340
CBR900RR R-X	93-99	YES	7503409
CBR900RR Y/1	00-01	NO	7503509
CBR900RR 2/3	02-03	NO	7503509
CB1000R	08>	NO	7503900
CBF1000	06>	NO	7503939
CBF1000F	10	NO	7503931
CBR1000RR	04-05	NO	7503809
CBR1000RR	06-07	NO	7503819
CBR1000RR	08-11	NO	7503949
CBR1000RR	08-11	YES	7503950
VTR1000 SP1 (RC51)	00-01	YES	7503609
VTR1000 SP2 (RC51)	02-06	YES	7503709
CB1300		NO	7503960
<b>HYOSUNG</b>			
GT650 R		NO	7509910
GT650 Naked/S		NO	7509940
<b>KAWASAKI</b>			
NINJA 250R (EX250)	08>	NO	7504110
ER6-F	06-09	NO	7504950
ER6-N	09>	NO	7504010
ER6-N	10>	NO	7504011
NINJA 650R	07-08	NO	7504310
ZX6R/RR/9R/12R (STREET)	98-04	NO	7504109
ZX6R/RR (RACE)	03-04	NO	7504209
ZX6R/RR	05-06	YES	7504409
ZX6R/RR	07-08	NO	7504410
ZX6R/RR	09-11	NO	7504420
Z750	03-06	NO	7504809
Z750	07>	NO	7504929
ZX7R	96-03	YES	7504309
ZX9R (RACE)	02-03	NO	7504509
Z1000	03-06	NO	7504809
Z1000	07-09	NO	7504929
Z1000	10>	NO	7504421
ZX10R	04-05	NO	7504909
ZX10R	06-07	NO	7504919
ZX10R	08-10	NO	7504949
ZX10R	08-10	YES	7504939
ZX10R	09-10	NO	7504941
ZX10R	11-12	NO	7504942
Z1000SX	11>	NO	7504320
ZRX1100/1200	99-05	NO	7504609
ZX14R	06-11	NO	7504709

MODEL	Year	Fairing Mod Required?	BLACK STP
<b>KTM</b>			
990 Superduke/R	07>	NO	7509932
990 Supermoto	08>	NO	7509931
1190 RC8	08>	NO	7509930
<b>MV AGUSTA</b>			
Brutale 750	02>	NO	7509950
Brutale 910	02>	NO	7509950
<b>SUZUKI</b>			
GSF600 BANDIT	>07	NO	7505969
GSF650 BANDIT	07>	NO	7505979
GSR600	06>	NO	7505949
GSXR600 V-Y	97-00	NO	7505109
GSXR600 K1-K3 (STREET)	01-03	NO	7505209
GSXR600 K4-K5	04-05	NO	7505409
GSXR600 K6-LO	06-10	NO	7505419
GSXR600 K6-LO	06-10	YES	7505429
GSXR600 K1	11>	NO	7505450
GSX650F	08>	NO	7505010
SVF650 Gladius		NO	7505011
SV650 (NOT S MODEL)	99-02	NO	7505509
SV650	03-10	NO	7505609
GSXR750 T-X	96-99	NO	7505109
GSXR750 Y-K3	00-03	NO	7505209
GSXR750 K4-K5	04-05	NO	7505409
GSXR750 K6-LO	06-10	NO	7505419
GSXR750 K6-LO	06-10	YES	7505429
GSXR750 K1	11>	NO	7505450
GSXR1000 K1-K2	01-02	NO	7505709
GSXR1000 K3-K4	03-04	NO	7505809
GSXR1000 K5-K6	05-06	NO	7505309
GSXR1000 K7-K8	07-08	NO	7505310
GSXR1000 K9-L1	09-11	YES	7505320
SV1000	03-07	NO	7505909
TL1000R	98-04	YES	7505119
GSF1200 BANDIT	>06	NO	7505969
GSF1250 BANDIT	07>	NO	7505979
GSXR1300 H'BUSA	99-07	YES	#
GSXR1300 H'BUSA	08>	YES	7505980
GSX1400	ALL	NO	7505929
B-KING	07>	NO	7505939
<b>TRIUMPH</b>			
Daytona 675	06>	NO	7509230
Street Triple 675	07>	NO	7509200
Speed Triple 1050	05>	NO	7509210
Tiger 1050		NO	7509220
<b>YAMAHA</b>			
YZF-R 125	08>	NO	7506050
FZ6	04-10	NO	7506319
FZ6R	10-12	NO	7506360
XJ6 DIVERSION	09>	NO	7506001
XJ6 DIVERSION F	09>	NO	7506360
XJ6 NAKED	09>	NO	7506370
YZF-R6	98-02	YES	7506209
YZF-R6	03-06	NO	7506309
YZF-R6 (RACE)	03-06	YES	7506219
YZF-R6	06-07	NO	7506329
YZF-R6	08-11	NO	7506349
YZF-R6	08-11	YES	7506350
TDM900	ALL	NO	7506040
FZ1	06-10	NO	7506800
FZ1	08-09	NO	7506810
YZF-R1	98-99	YES	7506409
YZF-R1	00-01	YES	7506909
YZF-R1	02-03	NO	7506119
YZF-R1	04-06	NO	7506709
YZF-R1	07-08	NO	7506719
YZF-R1	09>	NO	7506720
YZF-R1	09>	YES	7506740
CLUTCH SLIDER YZF-R6	98-05	NO	7506609
CLUTCH SLIDER YZF-R1	98-06	NO	7506609
XJR1200	ALL	NO	7506949
XJR1300	ALL	NO	7506949
FJR1300	06-07	NO	7506929

\* Crash protectors for bikes marked YES to 'Fairing Mod Required?' require alterations and cutting of the fairing.

MotoGP  
 Exhausts  
 Screens  
 Commuter  
 Controls  
 Headlights  
 Indicators  
 Mirrors  
 Rear Lights  
 Lifts & Stands  
 Tools  
 Batteries & Chargers  
 Electrics  
 Chain  
 Servicing  
 Tyres & Tubes  
 Security  
 Bike Accs  
 Luggage  
 Rider Accs  
 Tank Pads  
 Extras  
 www.biketeit.co.uk

## BikeTek Front Fork Adjusters

CNC adjusters mount onto forks allowing quick and simple adjustment  
 Premium 6061 aluminium  
 Available in sizes to fit the majority of modern bikes  
 Full range of OE manufacturer colours

Application list is not exhaustive – please check correct size required for bike when ordering



# BIKETEK

Size	Blue	Gold	Gunmetal	Green	Red
14mm	ADJ32BU	ADJ32GD	ADJ32GM	ADJ32GN	#
14mm round	ADJ34BU	ADJ34GD	ADJ34GM	#	ADJ34R
17mm	ADJ35BU	ADJ35GD	ADJ35GM	ADJ35GN	#
17mm round	ADJ33BU	ADJ33GD	ADJ33GM	#	#
19mm	ADJ36BU	ADJ36GD	ADJ36GM	ADJ36GN	ADJ36R
22mm	ADJ31BU	ADJ31GD	ADJ31GM	ADJ31GN	ADJ31R

MODEL	YEAR	SIZE
-------	------	------

APRILIA		
RSV 1000	SHOWA	22mm
RSV 1000	ÖHLINS	17mm

BMW		
S 1000 RR	10'-12'	17mm

DUCATI		
SHOWA	/	22mm
ÖHLINS	/	17mm

HONDA		
CBR 600 F/S	91'-10'	14mm rounded
CBR 600 RR	03'-04'	14mm rounded
CBR 600 RR	05'-06'	22mm
CBR 600 RR	07'-12	19mm
CBR 900 RR	92'-99'	14mm rounded
CBR 900 RR	00'-03'	22mm
CBR 1000 RR	04'-07'	22mm
CBR 1000 RR	08'-12	19mm
CB 1000 R	08'-12'	19mm
VTR 1000 F	00'-07'	14mm rounded
VTR 1000 SP1/2	00'-07'	22mm

KAWASAKI		
ZX 6R	98'-04'	17mm
ZX 6R/RR	05'-06'	22mm
ZX 6R	07'-08'	19mm
Z 750	07'-10'	14mm
ZX 9R	98'-03'	17mm
ZX 10R	04'-12	14mm
Z 1000	03'-06'	22mm
Z 1000	07'-09'	19mm
ZX 12R	00'-06'	17mm
ZZR 1400	08'-12	14mm

MODEL	YEAR	SIZE
-------	------	------

MV AGUSTA		
BRUTALE	ALL	19mm
F4 750/1000	99'-10'	19mm

SUZUKI		
GSX-R 600	97'-03'	14mm rounded
GSX-R 600	04'-05'	22mm
GSX-R 600	06'-12	19mm
GSX-R 750	92'-03'	22mm
GSX-R750	04'-05'	22mm
GSX-R 750	06'-12	19mm
GSX-R 1000	01'-08'	14mm
SV 1000 / S	03'-05'	14mm
TL 1000 S/R	97'-02'	17mm
B-KING	08'-12	14mm

TRIUMPH		
STREET TRIPLE 675	07'-12	14mm
DAYTONA 675	06'-12	14mm
DAYTONA 955 ie	99'-02'	14mm rounded
SPEED TRIPLE 955 ie	00'-04'	14mm rounded
SPEED TRIPLE 1050	05'-12	22mm

YAMAHA		
R6	99'-04'	17mm
R6	05'-12	14mm
FAZER 1000	00'-05'	17mm
FZ1 N/FAZER	06'-12	14mm
R1	98'-03'	14mm
R1	04'-12	14mm

Motorcycle  
 Exhausts  
 Screens  
 Commuter  
 Controls  
 Headlights  
 Indicators  
 Mirrors  
 Rear Lights  
 Lifts & Stands  
 Tools  
 Batteries & Chargers  
 Electrics  
 Chain  
 Servicing  
 Tyres & Tubes  
 Security  
 Bike Locks  
 Luggage  
 Rider Accs  
 Tank Pads  
 Extras  
 www.biketek.co.uk



## BikeTek CNC Footpegs

Premium aluminium CNC machined footpegs  
Single piece design ensures easy fitment  
Chunky machined pattern for optimum grip  
Features hard-wearing nylon slider cap



# BIKETEK



MODEL	YEAR	FRONT PEG	REAR PEG	COLOURS
-------	------	-----------	----------	---------

### Honda

CB600F Hornet	98-05	FPGHF11	FPGHR11	BLK / SL / GD / R
CBR600 F/Fi/FS	87-05	FPGHF11	FPGHR11	BLK / SL / GD / R
CBR600 RR	03-06	FPGHF11	FPGHR11	BLK / SL / GD / R
CBR600 RR	07>	FPGHF11	FPGHR11	BLK / SL / GD / R
CBR900 RR	92-05	FPGHF11	FPGHR11	BLK / SL / GD / R
CBR1000 RR	04-12	FPGHF11	FPGHR11	BLK / SL / GD / R
VTR1000 Firestorm	97-05	FPGHF11	FPGHR11	BLK / SL / GD / R
VTR1000SP	99-05	FPGHF11	FPGHR11	BLK / SL / GD / R
CBR1100XX	96-05	FPGHF11	FPGHR11	BLK / SL / GD / R

### Kawasaki

ZX6-R F/G	95-00	FPGKF11	#	BLK / SL / GD / GN
ZX6R/RR	03-06	FPGKF11	#	BLK / SL / GD / GN
ZX6R/RR	07>	FPGKF11	#	BLK / SL / GD / GN
ER6 F/N	06-07	FPGKF11	#	BLK / SL / GD / GN
ZR-7/S	99-04	FPGKF11	#	BLK / SL / GD / GN
ZX7-R	91-03	FPGKF11	#	BLK / SL / GD / GN
ZX9-R B/C	94-00	FPGKF11	#	BLK / SL / GD / GN
ZX9-R E/F	00-04	FPGKF11	#	BLK / SL / GD / GN
ZX10-R	04-12	FPGKF11	#	BLK / SL / GD / GN
Z1000	03-05	FPGKF11	#	BLK / SL / GD / GN

MODEL	YEAR	FRONT PEG	REAR PEG	COLOURS
-------	------	-----------	----------	---------

### Kawasaki cont...

ZZR1200	02-05	FPGKF11	#	BLK / SL / GD / GN
ZX12-R	00-05	FPGKF11	#	BLK / SL / GD / GN
ZZR1400	06-12	FPGKF11	#	BLK / SL / GD / GN

### Suzuki

GSXR600	97-12	FPGSU11	FPGSU11	BLK / SL / GD / BU
SV650/S	99-06	FPGSU11	FPGSU11	BLK / SL / GD / BU
GSXR750	96-12	FPGSU11	FPGSU11	BLK / SL / GD / BU
GSXR1000	01-12	FPGSU11	FPGSU11	BLK / SL / GD / BU
SV1000/S	03-06	FPGSU11	FPGSU11	BLK / SL / GD / BU
TL1000S/R	98-04	FPGSU11	FPGSU11	BLK / SL / GD / BU
GSF1200 Bandit	96-	FPGSU12	FPGSU12	BLK / SL / GD / BU
GSX1300R	99-07	FPGSU11	FPGSU11	BLK / SL / GD / BU

### Yamaha

YZF600 Thundercat	95-04	FPGYF11	FPGYR12	BLK / SL / GD / BU
YZF-R6	98-12	FPGYF11	FPGYR12	BLK / SL / GD / BU
FZS1000 Fazer	00-09	FPGYF11	FPGYR12	BLK / SL / GD / BU
YZF1000R T'Ace	96-03	FPGYF11	FPGYR12	BLK / SL / GD / BU
YZF-R1	00-12	FPGYF11	#	BLK / SL / GD / BU
FZ1	01-07	FPGYF11	FPGYR12	BLK / SL / GD / BU

Application list is not exhaustive

Order Code	Description
FPGPG99	Replacement nylon slider cap 1pc

Motorcyc

Exhausts

Screens

Commuter

Controls

Headlights

Indicators

Mirrors

Rear Lights

Lifts & Stands

Tools

Batteries & Chargers

Electrics

Chain

Servicing

Tyres & Tubes

Security

Bike Accs

Luggage

Rider Accs

Tank Pads

Extras

www.bikeit.co.uk



## Billet Aluminium Race Pegs

- Billet aluminium racing footpegs, designed to replace OEM's
- Aluminium material offers weight reduction over stock pegs
- Rigid 1pc construction - no assembly required
- Slash-Cut for increased ground clearance
- Machined sole grooves for optimum grip
- Uses existing OEM mounting hardware and springs
- Available in matt black and alloy finishes



# BIKETEK



BIKE	YEAR	Rider Alloy	Rider Black	Pillion Alloy	Pillion Black
<b>HONDA</b>					
CB600 Hornet	98-05	FRH010AL	FRH010BK	FRH025AL	FRH025BK
CBR600 F/FS	87-05	FRH010AL	FRH010BK	FRH025AL	FRH025BK
CBR600RR	03-10	FRH010AL	FRH010BK	FRH025AL	FRH025BK
VFR800 Fi	97-01	FRH010AL	FRH010BK	FRH025AL	FRH025BK
CBR900RR /919/929/954	93-08	FRH010AL	FRH010BK	FRH025AL	FRH025BK
CBR1000F	91-99	FRH010AL	FRH010BK	FRH025AL	FRH025BK
CBR1000RR	04-10	FRH010AL	FRH010BK	FRH025AL	FRH025BK
VTR1000 Firestorm	97-05	FRH010AL	FRH010BK	FRH025AL	FRH025BK
CBR1100XX	97-05	FRH010AL	FRH010BK	FRH025AL	FRH025BK
<b>KAWASAKI</b>					
GPZ500 S	87-04	FRK040AL	FRK040BK	FRK055AL	FRK055BK
GPX600 R	88-96	FRK040AL	FRK040BK	FRK055AL	FRK055BK
ZZ-R600 D/E	90-05	FRK040AL	FRK040BK	FRK055AL	FRK055BK
ZX-6R Ninja F/G	95-99	FRK040AL	FRK040BK	FRK055AL	FRK055BK
ZX-6R Ninja J/ 636 A1P	00-02	FRK040AL	FRK040BK	FRK095AL	FRK095BK
ZX-6R Ninja 636 B/K/M	03-04	FRK040AL	FRK040BK	FRK055AL	FRK055BK
ZX-6R/RR Ninja 636 C/N	05-08	FRK040AL	FRK040BK	FRK055AL	FRK055BK
ZR-7/S	99-04	FRK040AL	FRK040BK	FRK055AL	FRK055BK
ZXR750/R	89-96	FRK040AL	FRK040BK	FRK055AL	FRK055BK
ZX7R	96-03	FRK040AL	FRK040BK	FRK055AL	FRK055BK
ZX9R B/C	94-99	FRK040AL	FRK040BK	FRK055AL	FRK055BK
ZX9R E/F	00-04	FRK040AL	FRK040BK	FRK095AL	FRK095BK
Z1000	03-05	FRK040AL	FRK040BK	#	#
ZX-10R Ninja	04-07	FRK040AL	FRK040BK	FRK055AL	FRK055BK
ZZ-R1100	90-02	FRK040AL	FRK040BK	FRK055AL	FRK055BK
ZRX1100/1200	99-05	FRK040AL	FRK040BK	FRK055AL	FRK055BK
ZX-12R Ninja	00-05	FRK040AL	FRK040BK	FRK095AL	FRK095BK
ZZR1200	02-05	FRK040AL	FRK040BK	FRK055AL	FRK055BK
ZZR1400	06-09	FRK040AL	FRK040BK	FRK055AL	FRK055BK
<b>SUZUKI</b>					
GSX600/750F KATANA	87-05	FRS125AL	FRS125BK	FRS125AL	FRS125BK
GSX-R600 V-K5	97-05	FRS070AL	FRS070BK	FRS090AL	FRS090BK
GSX-R600	06-07	FRS080AL	FRS080BK	#	#
RF600	93-97	FRS070AL	FRS070BK	FRS080AL	FRS080BK
SV650/S	99-10	FRS070AL	FRS070BK	FRS090AL	FRS090BK
GSX-R750 WR/WS	88-95	FRS070AL	FRS070BK	FRS080AL	FRS080BK
GSX-R750 T-K5	96-05	FRS070AL	FRS070BK	FRS090AL	FRS090BK
GSX-R750	06-07	FRS080AL	FRS080BK	#	#
GSX-R1000 K1-K4	01-04	FRS070AL	FRS070BK	FRS090AL	FRS090BK
GSX-R1000 K5-K8	05-08	FRS080AL	FRS080BK	#	#
SV1000/S	03-10	FRS070AL	FRS070BK	FRS090AL	FRS090BK
TL1000R/S	97-05	FRS070AL	FRS070BK	FRS090AL	FRS090BK
GSX1300R Hayabusa	99-10	FRS080AL	FRS080BK	FRS090AL	FRS090BK
<b>YAMAHA</b>					
FZR600 Genesis	89-93	FRY140AL	FRY140BK	FRY155AL	FRY155BK
FZR600 R	94-96	FRY140AL	FRY140BK	FRY155AL	FRY155BK
SECA II	92-98	FRY140AL	FRY140BK	FRY155AL	FRY155BK
YZF600 R Thundercat	96-04	FRY140AL	FRY140BK	FRY155AL	FRY155BK
YZF-R6	99-10	FRY140AL	FRY140BK	FRY155AL	FRY155BK
YZF750 R/SP	93-96	FRY140AL	FRY140BK	FRY155AL	FRY155BK
FZR1000 R(Exup)	88-95	FRY140AL	FRY140BK	FRY155AL	FRY155BK
FZS1000 Fazer	00-07	FRY140AL	FRY140BK	FRY155AL	FRY155BK
YZF1000 R Thunderace	96-03	FRY140AL	FRY140BK	FRY155AL	FRY155BK
YZF-R1	98-99	FRY140AL	FRY140BK	FRY160AL	FRY160BK
YZF-R1	00-07	FRY140AL	FRY140BK	#	#

Motocp  
Exhausts  
Screens  
Commuter  
Controls  
Headlights  
Indicators  
Mirrors  
Rear Lights  
Lifts & Stands  
Tools  
Batteries & Chargers  
Electrics  
Chain  
Servicing  
Tyres & Tubes  
Security  
Bike Accs  
Luggage  
Rider Accs  
Tank Pads  
Extras  
www.biketek.co.uk



## Biketek Adjustable Footpegs

Biketek adjustable footpegs can be rotated in a full forward/back circle, enabling adjustment by 45 degree graduations and offering improved rider positioning. The mounting hardware features an octagon shaped mechanism which can be adjusted through eight possible settings, allowing the footpeg to be permanently set to the optimum position. Precision CNC machined footpeg, hanger and mounting block, with hard-wearing nylon slider tip.

# BIKETEK



**NEW**

MODEL	YEAR	FRONT PEG
<b>Honda</b>		
CB600F Hornet	98-05	PEGADH11
CBR600 F/FS	87-05	PEGADH11
CBR600 RR	03-06	PEGADH11
CBR600 RR	07>	PEGADH11
CBR900 RR	92-05	PEGADH11
CBR1000 RR	04-12	PEGADH11
VTR1000 Firestorm	97-05	PEGADH11
VTR1000SP	99-05	PEGADH11
CBR1100XX	96-05	PEGADH11
<b>Kawasaki</b>		
ZX6-R F/G	95-00	PEGADK11
ZX6R/RR	03-06	PEGADK11
ZX6R/RR	07>	PEGADK11
ER6 F/N	06-07	PEGADK11
ZR-7/S	99-04	PEGADK11
ZX7-R	91-03	PEGADK11
ZX9-R B/C	94-00	PEGADK11
ZX9-R E/F	00-04	PEGADK11
ZX10-R	04-12	PEGADK11
Z1000	03-05	PEGADK11
ZZR1200	02-05	PEGADK11

MODEL	YEAR	FRONT PEG
<b>Kawasaki cont...</b>		
ZX12-R	00-05	PEGADK11
ZZR1400	06-12	PEGADK11
<b>Suzuki</b>		
GSXR600	97-12	PEGADS11
SV650/S	99-06	PEGADS11
GSXR750	96-12	PEGADS11
GSXR1000	01-12	PEGADS11
SV1000/S	03-06	PEGADS11
TL1000S/R	98-04	PEGADS11
GSF1200 Bandit	96-	PEGADS13
GSX1300R	99-07	PEGADS11
<b>Yamaha</b>		
YZF600 Thundercat	95-04	PEGADY11
YZF-R6	98-12	PEGADY11
FZS1000 Fazer	00-09	PEGADY11
YZF1000R T'Ace	96-03	PEGADY11
YZF-R1	00-12	PEGADY11
FZ1	01-07	PEGADY11

Order Code Description  
**PEGADJ01** Replacement nylon slider tips (2pcs)

Application list is not exhaustive

## Universal Footrests

A selection of universal footrests for custom and project bikes. High-chrome finishes in a choice of styles, with universal clamp fitments.

Order Code Description  
**FRUORING** Sundance footrests  
**FRUDIA** Diamond shape footrests  
**FRUD012** Diamond shape footrests with 1 1/4" clamp  
**FRUCLAMP** Custom clamp on footrests  
**FRU10MM** Universal 10mm  
**FRUJES** Universal Jester with Diamond (clamp fit)  
**FRURAIL** Universal Rail chrome with inlays



## Billet Footrests

Premium quality billet footrests for custom and project bikes. Various fitment types including clamp-on, stud-type and bolt-mount.

Order Code Description  
**FRUBU** Standard type  
**FRUBS** Stud type  
**FRUBDL** Driver peg large  
**FRUBDS** Driver peg small  
**FRUBC** Clamp type

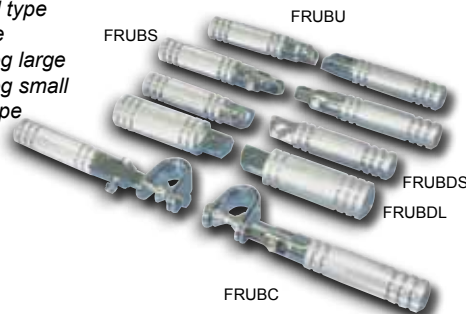

## OEM Replacement Footpegs

Replacement footpegs for Japanese road bikes. Quality and precision manufactured to be direct replacements for OEM footpegs at a fraction of the price.



Kawasaki  
 OEM: 34028-1429  
 34028-1428  
 Order Code: **FRK701**

Honda  
 OEM: 50635-MBW-000  
 50645-MBW-000  
 Order Code: **FRH102**

Yamaha  
 OEM: 4BH-27461-01  
 4BH-27451-01  
 Order Code: **FRY301**

Suzuki  
 OEM: 43526-31E01  
 43536-31E01  
 Order Code: **FRS502**

Honda  
 OEM: 50612-MM5-000  
 50642-MM5-000  
 Order Code: **FRH101**

Suzuki  
 OEM: 43511-40C00  
 43521-40C00  
 Order Code: **FRS501**

Motocp  
 Exhausts  
 Screens  
 Commuter  
 Controls  
 Headlights  
 Indicators  
 Mirrors  
 Rear Lights  
 Lifts & Stands  
 Tools  
 Batteries & Chargers  
 Electrics  
 Chain  
 Servicing  
 Tyres & Tubes  
 Security  
 Bike Accs  
 Luggage  
 Rider Accs  
 Tank Pads  
 Extras

www.bikeit.co.uk

## Alloy Sports Footrests

Replacement front and rear alloy footrests in tapered and round styles. Available in alloy, black, red, blue, green and gold.

Dependant on what colour you would like please add one of the following after the code:

CH (Alloy), BLK (Black), BU (Blue), R (Red), GN (Green), GD (Gold).



# BIKETEK

MODEL	YEAR	FRONT ROUND	FRONT TAPERED	REAR ROUND	REAR TAPERED
<b>Ducati</b>					
750SS	91-01	FRRDF01	FRTDF01	FRRDR01	FRTDR01
851	90-94	FRRDF01	FRTDF01	FRRDR01	FRTDR01
888S1		FRRDF01	FRTDF01	FRRDR01	FRTDR01
9071E	90-93	FRRDF01	FRTDF01	FRRDR01	FRTDR01
900SS	90-01	FRRDF01	FRTDF01	FRRDR01	FRTDR01
Superlight	92-96	FRRDF01	FRTDF01	FRRDR01	FRTDR01
<b>Honda</b>					
CB600F Hornet	98-05	FRRHF01	FRTHF01	FRRHR02	FRTHR02
CBR600	89-92	FRRHF01	FRTHF01	FRRHR01	FRTHR01
CBR600	93-05	FRRHF01	FRTHF01	FRRHR02	FRTHR02
CBR600RR	09-12	FRRHF01	FRTHF01	FRRHR02	FRTHR02
CBR900RR	92-05	FRRHF01	FRTHF01	FRRHR02	FRTHR02
CBR1000RR	04-12	FRRHF01	FRTHF01	FRRHR02	FRTHR02
VTR1000 Firestorm	97-05	FRRHF01	FRTHF01	FRRHR02	FRTHR02
VTR1000SP	99-05	FRRHF02	FRTHF02	FRRHR02	FRTHR02
CBR1100XX	96-05	FRRHF01	FRTHF01	FRRHR02	FRTHR02
<b>Kawasaki</b>					
GPZ500S	87-04	FRRKF01	FRTKF01	FRRKR01	FRTKR01
ZZR600	90-05	FRRKF01	FRTKF01	FRRKR01	FRTKR01
ZX6-R F/G	95-00	FRRKF01	FRTKF01	FRRKR01	FRTKR01
ZX6-R 636 B1/CM	03-04	FRRKF01	FRTKF01	FRRKR01	FRTKR01
ZX6-R 636 C/N	05-12	FRRKF01	FRTKF01	FRRKR01	FRTKR01
ZR-7/S	99-04	FRRKF01	FRTKF01	FRRKR01	FRTKR01
ZX7-R	96-03	FRRKF01	FRTKF01	FRRKR01	FRTKR01
ZX9-R B/C	94-00	FRRKF01	FRTKF01	FRRKR01	FRTKR01
ZX9-R E/F	00-04	FRRKF01	FRTKF01	FRRKR01	FRTKR01
ZX10-R	04-12	FRRKF01	FRTKF01	FRRKR01	FRTKR01
Z1000	03-05	FRRKF01	FRTKF01	FRRKR01	FRTKR01
ZZR1200	02-05	FRRKF01	FRTKF01	FRRKR01	FRTKR01
ZX12-R	00-05	FRRKF01	FRTKF01	FRRKR01	FRTKR01
ZZR1400	06-12	FRRKF01	FRTKF01	FRRKR01	FRTKR01
<b>Suzuki</b>					
GSF600 Bandit	96-01	FRRSFR02	FRTSFR02	FRRSFR01	FRTSFR01
GSX600	>01	FRRSFR01	FRTSFR01	FRRSFR01	FRTSFR01
GSXR600	97-12	FRRSFR01	FRTSFR01	FRRSFR01	FRTSFR01
SV650/S	99-06	FRRSFR01	FRTSFR01	FRRSFR01	FRTSFR01
GSX750	>01	FRRSFR01	FRTSFR01	FRRSFR01	FRTSFR01
GSXR750	88-95	FRRSFR01	FRTSFR01	FRRSFR01	FRTSFR01
GSXR750	96-12	FRRSFR01	FRTSFR01	FRRSFR01	FRTSFR01
GSXR1000	01-12	FRRSFR01	FRTSFR01	FRRSFR01	FRTSFR01
SV1000/S	03-06	FRRSFR01	FRTSFR01	FRRSFR01	FRTSFR01
TL1000S/R	98-04	FRRSFR01	FRTSFR01	FRRSFR01	FRTSFR01
GSF1200 Bandit	96-	FRRSFR02	FRTSFR02	FRRSFR02	FRTSFR02
GSX1300R	99-07	FRRSFR01	FRTSFR01	FRRSFR01	FRTSFR01
<b>Yamaha</b>					
YZF600 Thundercat	95-04	FRRYF01	FRTYF01	FRRYR01	FRTYR01
YZF-R6	98-12	FRRYF01	FRTYF01	FRRYR01	FRTYR01
YZF750 R/SP	93-97	FRRYF01	FRTYF01	FRRYR01	FRTYR01
FZS1000 Fazer	00-09	FRRYF01	FRTYF01	FRRYR01	FRTYR01
YZF1000R T'Ace	96-03	FRRYF01	FRTYF01	FRRYR01	FRTYR01
YZF-R1	98-99	FRRYF02	FRTYF02	FRRYR02	FRTYR02
YZF-R1	00-12	FRRYF01	FRTYF01	FRRYR01	FRTYR01
FZ1	01-07	FRRYF01	FRTYF01	FRRYR01	FRTYR01

MotoGP  
 Exhausts  
 Screens  
 Commuter  
 Controls  
 Headlights  
 Indicators  
 Mirrors  
 Rear Lights  
 Lifts & Stands  
 Tools  
 Batteries & Chargers  
 Electrics  
 Chain  
 Servicing  
 Tyres & Tubes  
 Security  
 Bike Accs  
 Luggage  
 Rider Accs  
 Tank Pads  
 Extras  
 www.biketek.co.uk



## Hour Meters

Hour meters record the actual running time of an engine to encourage correct servicing at regular intervals. The meter is accumulative and data is non-erasable.

- Works on any petrol engine, 2 or 4 stroke
- Low power consumption
- Easy installation
- Waterproof to IP68 standard
- Records and displays up to 99999 RPM (hour/tachometer) and 9999.9 hours (hour meter and hour/tachometer)
- Up to 2 year battery life, 17500 hours of standby time

Order Code Description

**MTR002** Hour Meter

**MTR004** Hour/Tacho

**NEW**



MTR004



MTR002

## Digital LCD Clock

Splash proof, self adhesive digital LCD clock with time and date function. Backlight feature.

Order Code: **LCDCLOCK**



## LED Illuminated Speedo

61mm Diameter Face Speedos with blue LED illumination. Features analogue speed dial, LCD functions of Total Distance, Trip 1 and Trip 2.

Order Code Description

**MSPM09** MPH Ratio 2:1 (140mph/h)

**MSPK09** KMH Ratio 1:4 (230km/h)



## Mechanical Cable Speedos & Tachos

All speedos & tachos - 65mm face

Order Code Description

**MSPMPH** Chrome mini speedo (MPH) - 60mph = 2240rpm

**MSPKMH** Chrome mini speedo (KPH)

**TAC01** Kawasaki chrome tachometer, 1:5 ratio

**TAC02** Honda chrome tachometer, 1:7 ratio

**TAC03** 1:4 ratios chrome tacho, fits Honda, Yamaha and Suzuki

This multi-purpose chrome mounting bracket provides an anchor point for accessories such as mini speedos and tachos. Fits all sizes of bars, complete with rubber sleeves for smaller diameters.

**MSP001** Universal handlebar bracket mount



MSP001

TAC03

TAC02

TAC01



MSPKMH

MSPMPH

## Analogue Yoke Clocks

Stainless steel bezel analogue clock, supplied complete with fitting kit to mount to motorcycle yoke.

Available in range of bezel finished and with either a white or glowing clock face.

Order Code Description

**CLKBG** Black / Glow Faced

**CLKBW** Black / White Faced

**CLKSG** Stainless Steel / Glow Faced

**CLKSW** Stainless Steel / White Faced

**CLKTG** Titanium / Glow Faced

**CLKTW** Titanium / White Faced



CLKBG



CLKSW

Motorcycle  
Exhausts  
Screens  
Commuter  
Controls  
Headlights  
Indicators  
Mirrors  
Rear Lights  
Lifts & Stands  
Tools  
Batteries & Chargers  
Electrics  
Chain  
Servicing  
Tyres & Tubes  
Security  
Bike Accs  
Luggage  
Rider Accs  
Tank Pads  
Extras

## Fairing Fasteners

Quick release fairing fasteners, replace original fairing bolts and enables quick and easy removal and fitting of motorcycle fairings. Available as slip-on and rivet-type anchors, with choice of fastener lengths.

Order Code	Description
<b>BOLQFS03</b>	Slip On 14mm 10pcs
<b>BOLQFS06</b>	Slip On 17mm 10pcs
<b>BOLQFS09</b>	Slip On 19mm 10pcs
<b>BOLQFS12</b>	Rivet 14mm 10pcs
<b>BOLQFS15</b>	Rivet 17mm 10pcs
<b>BOLQFS18</b>	Rivet 19mm 10pcs

**NEW**



Rivet Type



Slip On Type Type

## Exhaust Wrap

Exhaust and header pipe high-temperature tape, requires no wetting to fit. Highly durable and thermal shielding, the material is constructed from fibres extruded from pulverised lava rock. The wrap handles direct continuous heat over 700 degrees C, helping reduce heat transfer from exhaust systems. Supplied with stainless steel ties for fitting. 1" width, 50ft roll.

**NEW**

Order Code: **STKHRT04**



## Adhesive Heat Shield Sheet

Self-adhesive heat shield for bodywork protection from engine and exhaust heat. Supplied as a 50x50cm sheet, the shield can be precisely cut to the required shape and size for use on fairings and panels. Flexi aluminium top section, fibreglass inner with ultra-sticky adhesive backing.

**NEW**

Order Code: **STKHRT02**



## Fairing Mesh Detail

20\*33.5cm aluminium mesh panel, available in variety of colours to match bike. Mesh can be moulded and cut to specific shape to fill fairing intakes. Includes panel fittings

Order Code	Colour
<b>MSH001</b>	Black
<b>MSH003</b>	Gold
<b>MSH005</b>	Silver
<b>MSH007</b>	Red
<b>MSH009</b>	Blue



Motorcycle  
Exhausts  
Screens  
Commuter  
Controls  
Headlights  
Indicators  
Mirrors  
Rear Lights  
Lifts & Stands  
Tools  
Batteries & Chargers  
Electrics  
Chain  
Servicing  
Tyres & Tubes  
Security  
Bike Accs  
Luggage  
Rider Accs  
Tank Pads  
Extras

www.bikeit.co.uk



## Flange Head Bolts

Replacement carbon steel flange head bolts available in all popular sizes. Supplied in 25pcs/pack.

Order Code	Size
<b>BOLFLG01</b>	M6 x 12 (25PCS)
<b>BOLFLG03</b>	M6 x 16 (25PCS)
<b>BOLFLG05</b>	M6 x 20 (25PCS)
<b>BOLFLG07</b>	M6 x 25 (25PCS)
<b>BOLFLG09</b>	M6 x 30 (25PCS)
<b>BOLFLG11</b>	M6 x 35 (25PCS)

**NEW**



## Universal Screw Sets

These great colour-coded kits include 150 anodised alloy screws, nuts and washers in M5 and M6 threads. Screw lengths range from 10mm to 30mm, with button-head, countersunk and allen-head options.

Order Code	Description
<b>USS150BK</b>	Black
<b>USS150BU</b>	Blue
<b>USS150CH</b>	Silver
<b>USS150GD</b>	Gold
<b>USS150R</b>	Red



## Sprocket Bolt Kit

6pc sprocket bolt and nut kit. Chrome Moly (CRMO) M8\*25mm bolts (1.25 pitch). Countersunk allen head. Nylon-locking carbon steel nuts.

Order Code: **SPNKIT11**



## Rear Sprocket Nut Kit

Lightweight alloy upgrade rear sprocket nuts. Stainless steel inner threads for optimum strength. Available in 10mm and 12mm versions, 6 pieces per pack. Choice of colours.

Order Code	Colour	Size
<b>SPN10BK</b>	Black	10mm
<b>SPN10BU</b>	Blue	10mm
<b>SPN10GD</b>	Gold	10mm
<b>SPN10R</b>	Red	10mm
<b>SPN10S</b>	Silver	10mm
<b>SPN12BK</b>	Black	12mm
<b>SPN12BU</b>	Blue	12mm
<b>SPN12GD</b>	Gold	12mm
<b>SPN12R</b>	Red	12mm
<b>SPN12S</b>	Silver	12mm



## Allen Bolt Caps

These chrome effect caps simply pop onto allen bolt heads, for improved appearance and bolt protection. Available in three sizes, 12pcs/pack. **NEW**

Order Code	Description
<b>BOLCAP06</b>	M6 fitment (12pcs)
<b>BOLCAP08</b>	M8 fitment (12pcs)
<b>BOLCAP10</b>	M10 fitment (12pcs)



## Number Plate Bolts

Nylon number plate fixing bolts and nuts supplied in cartons of 50 pieces.

Order Code	Colour
<b>BOLNUM01</b>	Black
<b>BOLNUM02</b>	Yellow
<b>BOLNUM03</b>	White

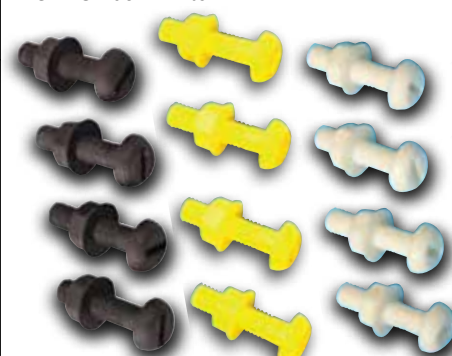

## Oil Cleaning Bolts

Order Code	Colour	Size
<b>OCB12BU</b>	Blue	12mm
<b>OCB12R</b>	Red	12mm
<b>OCB12GD</b>	Gold	12mm
<b>OCB12AL</b>	Alloy	12mm
<b>OCB10AL</b>	Alloy	10mm

Magnetised bolts attract shards of waste in oil which can damage engines.



Motorcycle  
Exhausts  
Screens  
Commuter  
Controls  
Headlights  
Indicators  
Mirrors  
Rear Lights  
Lifts & Stands  
Tools  
Batteries & Chargers  
Electrics  
Chain  
Servicing  
Tyres & Tubes  
Security  
Bike Accs  
Luggage  
Rider Accs  
Tank Pads  
Extras

## Race Gas Caps

Lightweight aluminium fuel filler caps, direct OEM replacement uses bike's existing fitting bolts. Keyless for quick fuelling. Available in standard and quarter-turn options. CNC machined, with Biketek laser etched detail.



**BIKETEK**

Description	Standard Order Code	1/4 Turn Order Code
Aprilia (3 bolt)	FFCA01	FFCA05
Aprilia	FFCA02	FFCA06
Ducati (5 bolt)	FFCD01	FFCD05
Honda (3 bolt)	FFCH01	FFCH05
Kawasaki (3 bolt)	FFCK01	FFCK05
Suzuki (3 bolt)	FFCS01	FFCS05
Suzuki (4 bolt)	FFCS02	FFCS06
Triumph (3 bolt)	FFCA01	FFCA05
Yamaha (3 bolt)	FFCY01	FFCY05

### CODE\*\* YEAR

#### Aprilia

##### FFCA01 fits:

RS50/125/250/RSV  
Mille

##### FFCA02 fits:

RSV Mille Factory

#### Ducati

##### FFCD01 fits:

851 / 888  
748 / 916 / 996  
955  
Monster 600/750/900  
SS 600/750/900  
ST2 / ST4

#### Honda

##### FFCH01 fits:

CBR600F	91-07
CBR600RR	03-12
CBR900/929/954	93-05
CBR1000RR	04-12
VTR1000 SP1/2	00-06
CBR1100XX	97-05
VTR1000F	98-05

#### Kawasaki

##### FFCK01 fits:

ZX6R / RR	00-12
ZX9R	00-03
Z1000	03-12
ZX10R	04-06

### CODE\*\* YEAR

#### Suzuki

##### FFCS01 fits:

SV650	03-06
GSXR600	04-08
GSXR750	04-08
SV1000	03-06
GSXR1000	04-08

#### Suzuki

##### FFCS02 fits:

GSF600	00-01
SV650	99-02
GSXR600	96-03
GSXR750	96-03
GSXR1000	01-03
GSXR1300	99-07
GSF1200	01-04
TL1000S/R	97-04
GSX600/750	98-04

#### Triumph

##### FFCA01 fits:

675

#### Yamaha

##### FFCY01 fits:

FZR600	94-99
YZF600	94-05
R6	99-12
FZR1000	89-95
YZF1000R	97->
R1	98-12

### 1/4 Turn



FFCA05

FFCA06



FFCD05

FFCH05

FFCK05

FFCS05

FFCS06

FFCY05

### Standard



FFCA01

FFCA02



FFCD01

FFCH01

FFCK01

FFCS01

FFCS02

FFCY01



# Petrol Caps

Model	Order Code
<b>HONDA</b>	
NS125RH/R2H/RK/RL	<b>FCPH02</b>
NSR125P/RR/RS/RV/RW	<b>FCPH01</b>
NSR125FJ	<b>FCPH02</b>
NSR125FK/FL/FM/FP/ RK/RL/RM/RN	<b>FCPH02</b>
CBR250RRL/RRN/RRR/RRR-2	<b>FCPH01</b>
NSR250R7L (MC21)	<b>FCPH02</b>
CBR400RRN/RRR/RRR-2 (AERO)	<b>FCPH01</b>
NS400F	<b>FCPH01</b>
VFR400R3L (NC30)	<b>FCPH01</b>
CBR600FN/FP/FR/FS/ FT/FV/ FW/FX	<b>FCPH01</b>
NTV600J/K/L (Revere)	<b>FCPH01</b>
CB750F2R/F2S/F2T/F2V/F2X	<b>FCPH01</b>
CBX750FE	<b>FCPH01</b>
RVF750RS (RC45)	<b>FCPH01</b>
VFR750FM/FN/FP/FR/FS/ FT/FV	<b>FCPH01</b>
XRV750/S/T/V/W/X (Africa Twin)	<b>FCPH01</b>
VFR800F1W	<b>FCPH01</b>
CBR900RRP/RRR/RRS/RRT	<b>FCPH01</b>
CB1000FR/R/FS/S/FT/T (Big1)	<b>FCPH01</b>
CBR1000FH/-FV/FX	<b>FCPH01</b>
XL1000VX (Varadero)	<b>FCPH01</b>
CBR1100XXV/XXW (Super Blackbird)	<b>FCPH01</b>
<b>KAWASAKI</b>	
EX250H1/H2 (ZZR)	<b>FCPK01</b>
KL250A3/A4/C1/C2	<b>FCPK01</b>
KR250C2/C3 (KR1S)	<b>FCPK01</b>
ZX400L1-L5/L8 (ZXR)	<b>FCPK01</b>
EX500A1-A6/D1-D3/D5 (GPZ500S)	<b>FCPK01</b>

Model	Order Code
<b>KAWASAKI cont...</b>	
KLE500A1-A7	<b>FCPK01</b>
ZR550B2-B6 (Zephyr)	<b>FCPK01</b>
ZX600E1-E6 (ZZR)	<b>FCPK01</b>
ZX600F1-F3/G1 (Ninja ZX-6R)	<b>FCPK01</b>
ZR650C1-D1 (Zephyr)	<b>FCPK01</b>
ZX750H1/H2/J1/J2/L1-L3 (ZXR)	<b>FCPK01</b>
ZX750K1/M1/M2 (ZXR750R)	<b>FCPK01</b>
ZX750N1 (Ninja ZX-7RR)	<b>FCPK01</b>
ZX750P1-P3 (Ninja ZX-7R)	<b>FCPK01</b>
ZX900B1-B4/C1 (Ninja ZX-9R)	<b>FCPK01</b>
ZX1100C1/C2/C2A/C3/D1-D6 (ZZR)	<b>FCPK01</b>
ZX1100E1 (GPZ1100E1)	<b>FCPK01</b>
ZX1100E2 (GPX1100S)	<b>FCPK01</b>
ZX1100F1 (GPZ1100ABS)	<b>FCPK01</b>
<b>SUZUKI</b>	
RG125FP/FR/FN/RUN/FUP/ FUR (Gamma)	<b>FCPS01</b>
RG125UN (Wolf)	<b>FCPS01</b>
RGV250K/L/M/M/P/R/T	<b>FCPS01</b>
GS500 All	<b>FCPS01</b>
GSF600S/T/ST/V/SV/W/W/S/ US/UT/UV/	<b>FCPS01</b>
GSX600FJ/FK/FL/FM etc	<b>FCPS01</b>
RF600RP/RUV	<b>FCPS01</b>
GSX750FK/FL/FM/FN/FP/ FR/FS	<b>FCPS01</b>
GSX-R750J/K/L/M/WN/WP/ WR/WS	<b>FCPS01</b>
GSXR750ORK (RR)	<b>FCPS01</b>
DR800SM/SUM (Desert Express-DR Big)	<b>FCPS01</b>

Model	Order Code
<b>SUZUKI cont...</b>	
VX800L/UL/M/UM/N/UN/P/ UR/R	<b>FCPS01</b>
RF900RR/RS/RS2/RT/RV/RW	<b>FCPS01</b>
GSX1100G/GN	<b>FCPS01</b>
GSXR1100K/L/M/N/ (Slingshot)	<b>FCPS01</b>
GSXR1100WP/WR/WS	<b>FCPS01</b>
WSKS/WSKT/WT	<b>FCPS01</b>
GSF1200T/ST/V/W/SV/SW (Bandit)	<b>FCPS01</b>
<b>YAMAHA</b>	
TZR125 87/89/90TDR250 88/90	<b>FCPY01</b>
TZR250 87-89	<b>FCPY01</b>
RD350LC/LCF 86	<b>FCPY01</b>
FZR400RR 92/RRSP	<b>FCPY01</b>
FZ600 (Fazer) 87-88	<b>FCPY01</b>
FZR600 95	<b>FCPY01</b>
SRX600 86/87	<b>FCPY01</b>
XJ600N 96/98	<b>FCPY01</b>
XJ600S (Diversión) 92/96/98	<b>FCPY01</b>
YZF600R (Thundercat) 96/98	<b>FCPY01</b>
FZ750 (Genesis) 86-91	<b>FCPY01</b>
YZF750SP 93	<b>FCPY01</b>
YZF750R 93/95/96	<b>FCPY01</b>
TDM850 92-96/98	<b>FCPY01</b>
TRX850 96/98	<b>FCPY01</b>
XJ900S (Diversión) 94/96-98	<b>FCPY01</b>
FZR1000 (Genesis) 87-90/92/94/95	<b>FCPY01</b>
FZR1000Rexup	<b>FCPY01</b>
YZF1000R (Thunderace) 96/98	<b>FCPY01</b>
FJ1200 88/90/92/A 92	<b>FCPY01</b>

FCPY01



Yamaha 3 bolt fits most Yamahas

FCPH02



FCPK01

Kawasaki 4 bolt fits models up to 1999

FCPS01



Suzuki 4 bolt fits most Suzuki pre 2003



FCPH01

Honda 3 bolt fits most Honda models

- Motorc
- Exhausts
- Screens
- Commuter
- Controls
- Headlights
- Indicators
- Mirrors
- Rear Lights
- Lifts & Stands
- Tools
- Batteries & Chargers
- Electrics
- Chain
- Servicing
- Tyres & Tubes
- Security
- Bike Accs
- Luggage
- Rider Accs
- Tank Pads
- Extras

## Licence Permit Holder

Clear plastic holder for licenses and permits. Simple clamshell folding design with mounting hole. 117x87mm

Order Code: **TDHPRCT**

**NEW**



## Gel Tax Disc Holders

Clear 3D gel design. Self-adhesive and flexible holder, offering endless mounting options on motorcycle fairing, screens, tanks etc. Can be placed on topside or underside of screens. Suitable also for use inside car windscreens. Features colour surround. Fully waterproof. Sold individually.

Order Code	Colour
<b>TDHGELBLK</b>	Black
<b>TDHGELBU</b>	Blue
<b>TDHGELGN</b>	Green Fluoro
<b>TDHGELR</b>	Red
<b>TDHGELSL</b>	Silver
<b>TDHGELY</b>	Yellow Fluoro



## Carbon Fibre Tax Disc Holder

Real carbon fibre backing and bezel. Allen bolt fitting. Waterproof seal.

Order Code: **TDHCBN01**



## Square Licence Holders

Alloy tax disc / license holder in square shape for Continental Europe. Allen bolt fitment bezel. 52x52mm window. Includes allen key.

Order Code	Colour
<b>TDHSQBLK</b>	Matt Black
<b>TDHSQSL</b>	Brushed Silver



## Basic Tax Disc Holders

Features metal body with rubber edge seal.

Order Code	Description
<b>TDH001</b>	Basic Black
<b>TDH002</b>	Basic Black (pack of 20)



## Custom Tax Disc Holder

Classic custom tax disc holders, available in high chrome and matt black. Bolt fixing on backing plate.

Order Code	Description
<b>TDH003</b>	Chrome
<b>TDH004</b>	Black



## Plastic Tax Disc Holders

This original budget plastic holder features simple clip-in window closure. Supplied on a card of 10 pieces.

Order Code	Description
<b>TDHPBLK</b>	Black (per 10)
<b>TDHPW</b>	White (per 10)



Motocp  
Exhausts  
Screens  
Commuter  
Controls  
Headlights  
Indicators  
Mirrors  
Rear Lights  
Lifts & Stands  
Tools  
Batteries & Chargers  
Electrics  
Chain  
Servicing  
Tyres & Tubes  
Security  
Bike Accs  
Luggage  
Rider Accs  
Tank Pads  
Extras

www.bikeit.co.uk



## Trident Tax Disc Holders

Exclusive "Trident" tax disc holder.

- Solid Colour bezel
- Extra safe 6 allen bolt fixing.

Order Code	Description
<b>TDHTRIBU</b>	Blue
<b>TDHTRICBN</b>	Carbon Look
<b>TDHTRIALL</b>	Alloy
<b>TDHTRIY</b>	Yellow
<b>TDHTRIGN</b>	Green
<b>TDHTRIR</b>	Red
<b>TDHTRICH</b>	All Chrome
<b>TDHTRIOR</b>	Orange
<b>TDHTRIBLK</b>	Black



Backing Plate finish may vary from picture

## Ninja Star Tax Disc Holders

Exclusive "Ninja Star" tax disc holder.

- Coloured bezel.
- Extra safe 6 allen bolt fixing.

Order Code	Colour
<b>TDHNJBU</b>	Blue
<b>TDHNJBLK</b>	Black
<b>TDHNJCBN</b>	Carbon look
<b>TDHNJCH</b>	Chrome
<b>TDHNJGD</b>	Gold
<b>TDHNJGN</b>	Green
<b>TDHNJPU</b>	Purple
<b>TDHNJR</b>	Red



Backing Plate finish may vary from picture

## Hexagon Tax Disc Holders

Hexagon shaped tax disc holder with allen bolt bezel for extra security.

Order Code	Colour
<b>TDHHCBN</b>	Carbon look
<b>TDHHBLK</b>	Black
<b>TDHHBU</b>	Blue
<b>TDHHCH</b>	Chrome
<b>TDHHGD</b>	Gold
<b>TDHHGN</b>	Green
<b>TDHHR</b>	Red



Backing Plate finish may vary from picture

MotoGP  
 Exhausts  
 Screens  
 Commuter  
 Controls  
 Headlights  
 Indicators  
 Mirrors  
 Rear Lights  
 Lifts & Stands  
 Tools  
 Batteries & Chargers  
 Electrics  
 Chain  
 Servicing  
 Tyres & Tubes  
 Security  
 Bike Accs  
 Luggage  
 Rider Accs  
 Tank Pads  
 Extras  
 www.bikeit.co.uk

### Licence Plate Mudflap

Easy installation mudflap extender bolts to the reverse side of licence plates. Provides 150mm protection below the license plate. Complete with fitted reflector. Mounting area 180x98mm.

Order Code: **MUD019**

**NEW**



### L Plates

Order Code	Description
<b>LPT01</b>	Self Adhesive (pack of 10)
<b>LPT02</b>	Tie-On (4 hole) (pack of 10)
<b>LPT03</b>	Rigid 2mm thick (pack of 10)
<b>LPT04</b>	Rigid 2mm thick with Fixing brackets (pack of 10)



### Mudflaps

Easy to install mudflaps fit to fenders or number plates. Available in plain black or L-Plate design.

Order Code	Description
<b>MUD011</b>	Black
<b>MUD015</b>	L-Plate

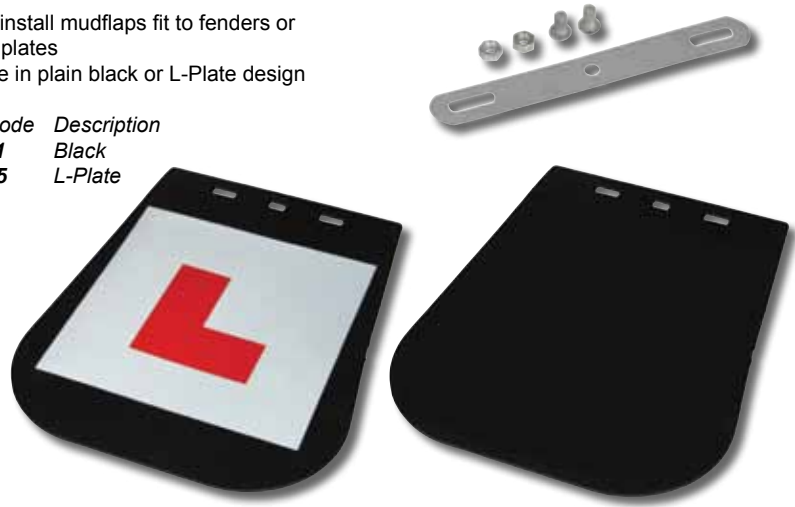

### Reflector Kits

- 22mm x 94mm self-adhesive reflector kits
- Available in red and amber
- Sold in pairs
- E-marked

Order Code	Colour
<b>REF006</b>	Red
<b>REF003</b>	Amber

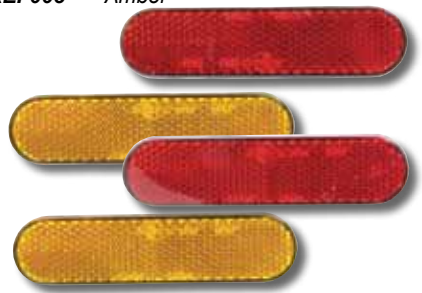

### Reflective Sticker Set

- Self-adhesive stickers
- Place on motorcycles and vehicles for increased visibility and safety
- 20pcs round sticker
- 4pcs rectangle sticker

Before fitting ensure area where sticker is to be placed is clean, dry and free from grease.

Order Code: **REFSTK7**

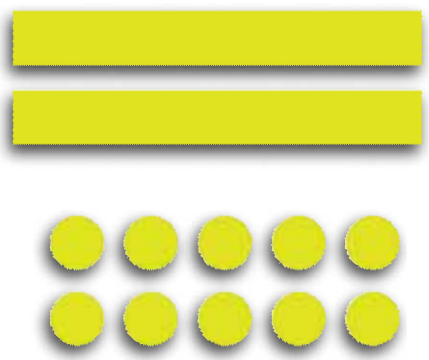

### Number Plate Reflector Bolts

Compact round reflector mounted on butterfly fixing bolt, ideal for number plate fitting. 20mm diameter.

Order Code: **REFNUM**



### Racing Numbers

Self adhesive race numbers for use on fairings, cowls and number boards.

Available in 6 & 8" size in Blue (**BU**), White (**W**) and Black (**B**) colour. Sold as packs of 10pcs of single number.

To order numbers, use Order Code: **STK**, followed by the size (**6** or **8**) then colour (Blue, Black or White), then number required (**0-9**).  
eg. **STK8W9** = Pack of 8" White in number 9.



### Stick On Number Plate Reflectors

Self adhesive. 20mm diameter.

Order Code	Description
<b>REF009</b>	2 pc pack
<b>REF012</b>	50pc pack





## LED Detail Light

A tiny detail light unit contains 3 white LED's. Use as number plate light, marker light or behind bodywork. Size: 44mm x 12mm x 7mm  
12v 0.3w

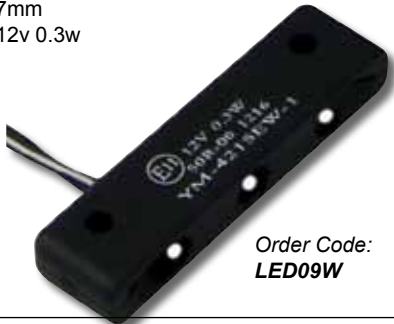

Order Code:  
**LED09W**

## Custom Detail Bolts

Decorative chrome finish custom bolts, complete with washers and nuts. Choose from eagle and skull designs.

Order Code	Description
<b>BOLEAG</b>	Eagle (4pcs)
<b>BOLSKULL</b>	Skull (1pc)



## LED Spear Marker Lamps

12v LED's inset in a chrome-effect based marker lamp unit (55 X 25 X 30mm). Constant illumination LED's create a colour co-ordinated neon glow. Available in 4 LED colours - Blue, Green, Red and White. Self-adhesive backing for universal fitting.

Order Code	Description
<b>LEDMAR1BU</b>	Blue LED
<b>LEDMAR1GN</b>	Green LED
<b>LEDMAR1R</b>	Red LED
<b>LEDMAR1W</b>	White LED



## LED Skull Bolt

Detailed chrome Skull Bolts complete with inset bright red LED eyes. The bolts are easy to fit and simply wire into bike electrics for constant, eye-catching illumination.

Order Code: **LEDSKUR**



## LED Glo-Strips

- Easy-install bike decoration kit
- Stunning LED illumination
- Waterproof construction

This LED decoration kit contains 1 pc self-adhesive, flexible LED strip (30cm). The strip is easily stuck onto motorcycle fairings, nose cones, tails, bending to the exact contour of the bodywork.

Simply connect into the bike's lighting circuit (12v) for constant LED illumination, or into indicator circuits as additional safety feature.\*

Available in colours to suit all bikes, LED GLO STRIPS offer great styling with increased visibility.

\* Should be used in conjunction with existing indicators, not intended as replacement indicators. It is the owners/fitters responsibility to ensure correct installation.

Order Code	Description
<b>LED08BU</b>	LED Glo strip blue 12v
<b>LED08GN</b>	LED Glo strip green 12v
<b>LED08R</b>	LED Glo strip red 12v
<b>LED08W</b>	LED Glo strip white 12v
<b>LED08Y</b>	LED Glo strip yellow 12v



## Bike Stand Pads

Saves your stand sinking in the mud, protects driveways and pavements. Random colours.

Order Code	Description
<b>BSPOVAL</b>	Bike-stand pad oval
<b>BSPOVAL10</b>	Bike-stand pad oval (10 pcs card set)



Colours may vary from those shown.

## Fork Protectors

Protectors strap over forks, protecting them from stone chips and scratching!

Order Code	Colour
<b>FKP01</b>	Black



Motorcycle  
Exhausts  
Screens  
Commuter  
Controls  
Headlights  
Indicators  
Mirrors  
Rear Lights  
Lifts & Stands  
Tools  
Batteries & Chargers  
Electrics  
Chain  
Servicing  
Tyres & Tubes  
Security  
Bike Accs  
Luggage  
Rider Accs  
Tank Pads  
Extras

## Deluxe Polyester Ventilated Raincovers

- Rip-Stop polyester construction with water repellent coating
- Shape to fit styling
- Aluminised lower section to prevent exhaust melt
- Anti-condensation ventilators
- Fitted elasticated bottom seam
- Tie-down grommets and "under bike" securing elastic
- Storage bag

Order Code	Description
<b>RCODELM</b>	Medium protective cover up to 500cc
<b>RCODELL</b>	Large protective cover up to 750/1100cc
<b>RCODELXL</b>	X.Large protective cover 1200cc plus



## Heavy Duty PVC Raincovers

- P.V.C. construction
- Shape to fit styling
- Storage bag

Order Code	Description
<b>RCOM</b>	Medium rain cover up to 500cc
<b>RCOL</b>	Large rain cover up to 750/1100cc
<b>RCOXXL</b>	X.Large rain cover 1200cc plus



## Indoor Dust Covers

Indoor dust covers are designed for long-term storage of motorcycles and protection from dust or dirt in the garage or workshop.

- Breathable non-woven material
- Shape to fit styling
- Ventilated
- Tie-down grommets and "under bike" securing elastic
- Storage bag

Order Code	Description
<b>RCOIDRM</b>	Medium (fits >500cc)
<b>RCOIDRL</b>	Large (fits 750-1100cc)
<b>RCOIDRXL</b>	X.Large (fits 1200cc>)



## ATV Raincover

- Polyester construction
- Shape to fit styling
- Aluminised lower section to prevent exhaust melt
- Anti-condensation ventilators
- Fitted elasticated bottom seam
- Tie-down grommets and "under ATV" securing elastic
- Storage bag

Order Code	Description
<b>RCOATV01</b>	Small 50-250cc
<b>RCOATV02</b>	Large 250+cc



Motorcycle  
Exhausts  
Screens  
Commuter  
Controls  
Headlights  
Indicators  
Mirrors  
Rear Lights  
Lifts & Stands  
Tools  
Batteries & Chargers  
Electrics  
Chain  
Servicing  
Tyres & Tubes  
Security  
Bike Bags  
Luggage  
Rider Accs  
Tank Pads  
Extras



## Premium Motorcycle Cover

- Offering maximum bike protection, this rain cover will provide bike protection from rain and environmental soiling.
- Generous sized cover made from premium PVC
- Totally waterproof for maximum protection
- Non-woven backing prevents bodywork abrasion
- Elasticated edges at ends for secure fit
- Underbike securing strap
- Features additional webbing strap extender to wrap over bike for closer fitment
- Reinforced holes at base for security chain access

Order Code	Description
<b>RCOPREM</b>	Medium - up to 600cc
<b>RCOPREL</b>	Large - up to 1000cc
<b>RCOPREXL</b>	Extra Large - 1200cc plus



## Motorcycle Top Cover

- Protects upper half of bike from rain, wind and environmental soiling.
- Protects seat, handlebars and tank in sunny conditions.
- Keeps seat, controls and electrics clean and dry
- Compact size and pillion seat bag provides bike protection on the move - ideal for commuter use
- Multi-securing points; elasticated skirt, front fairing strap, foot-control and pillion-peg straps

Offering lightweight and compact bike protection on the move, this top cover design will provide limited protection from rain. It is intended for periods of short use, such as when parked at work location.

Order Code	Description
<b>RCOTOPM</b>	Medium - up to 600cc
<b>RCOTOPL</b>	Large - up to 750/1100cc



## "URBAN" Scooter Apron

- Provides wind and rain protection for rider
- Simple waist fitment by adjustable webbing belt and buckle
- Apron is tailor-fitted to rest over legs when riding
- Thick and durable oxford outer layer
- Inner fleece lining for maximum warmth
- 2 side pockets with reflective piping
- Supplied with storage bag

Order Code: **RCOLEG02**



## "CHASER" Scooter Apron

- Provides wind and rain protection for rider
- Connects to scooter by webbing straps and velcro closures
- Bib fitment for additional rider protection
- Apron is designed to attach to scooter, creating protective cover for legs
- Thick and durable oxford outer layer
- Inner fleece lining for maximum warmth
- Folds flat into internal storage compartment with shoulder strap when not in use
- Supplied with storage bag

Order Code: **RCOLEG03**



Motocp  
Exhausts  
Screens  
Commuter  
Controls  
Headlights  
Indicators  
Mirrors  
Rear Lights  
Lifts & Stands  
Tools  
Batteries & Chargers  
Electrics  
Chain  
Servicing  
Tyres & Tubes  
Security  
Bike Accs  
Luggage  
Rider Accs  
Tank Pads  
Extras

**NEW**

### Smart Phone Handlebar Holder

This handlebar mounted holder is made from weather resistant PVC with waterproof zip closure, providing a secure pod for smartphones and GPS devices. The PVC surface enables use of touch screens without removing from the case. Features water-resistant silicone port for lead entry. Includes a 360° swivel bar-mount allowing optimum device positioning, with quick release adjuster. Fits 22 and 25mm diameter bars. Available in two sizes.

Order Code	Description
<b>LUGGPS10</b>	Small 12x6.5cm, fits smaller devices such as iPhone 4S, Blackberry
<b>LUGGPS14</b>	Medium 13.5x8cm, fits larger devices such as iPhone 5, Sat Navs etc



### Sat Nav / GPS Holder

- Handlebar / Yoke fitting holder for Sat Nav and GPS devices
- Clear vinyl top allows viewing of device
- Rubber cable port
- Single zip-closing compartment for device positioning, second base compartment for accessories
- Velcro fit over-case for additional water-repellency

Order Code:  
**LUGGPS06**



### Sat Nav / GPS Holder

- Handlebar / Yoke fitting holder for Sat Nav and GPS devices
- Clear vinyl top allows viewing of device
- Rubber cable port
- Main compartment for device positioning, second base compartment for accessories
- Clip-on over-case for additional water-repellency

Order Code: **LUGGPS02**



### Smart Phone Tank Holder

- Compact zip-close pouch designed for storing smart phones.
- Clear vinyl top allows viewing of phone screen
- Rubber cable port
- Magnetic fitting to petrol tank

Order Code: **LUGTNK36**



Motocp  
Exhausts  
Screens  
Commuter  
Controls  
Headlights  
Indicators  
Mirrors  
Rear Lights  
Lifts & Stands  
Tools  
Batteries & Chargers  
Electrics  
Chain  
Servicing  
Tyres & Tubes  
Security  
Bike Accs  
Luggage  
Rider Accs  
Tank Pads  
Extras

www.bikeit.co.uk



## Diablo Panniers

- Contoured compact panniers
- Each pannier expands from 10 litres to 21 litres (42 litre max)
- Zip-close side pockets
- Reinforced and padded internal wall
- Webbing straps offer optimum fitment options
- Includes rain covers

Order Code: **LUGPNR12**



## Urbano Panniers

- Contoured full-size panniers
- Each pannier expands from 24 litres to 38 litres (76 litre max)
- Zip-close side pockets
- Reinforced and padded internal wall
- Webbing straps offer optimum fitment options
- Includes rain covers

Order Code: **LUGPNR09**



## Urbano Tail Pack

- Contoured design tail pack
- Expanding main compartment
- Zip-close side pockets
- Includes shoulder strap
- Converts to rucksack when off bike
- Removeable neoprene base protector
- Attaches to motorbike by strong elastic straps
- Includes rain cover

Order Code: **LUGTAL06**



## Tail Pack

- Traditional design tail pack
- Expanding main compartment
- Zip-close side pockets
- Converts to rucksack when off bike
- Attaches to motorbike by strong elastic straps
- Includes rain cover

Order Code: **LUGTAL04**



Motocp  
Exhausts  
Screens  
Commuter  
Controls  
Headlights  
Indicators  
Mirrors  
Rear  
Lights  
Lifts &  
Stands  
Tools  
Batteries &  
Chargers  
Electrics  
Chain  
Servicing  
Tyres &  
Tubes  
Security  
Bike  
Accs  
Luggage  
Rider  
Accs  
Tank  
Pads  
Extras

## ABS Top Box

ABS luggage top boxes.

Universal fitting bracket will fit most carrier racks.

The top-box can be removed from fitting bracket when not in use, using the anti-tamper quick release mechanism activated securely from inside the box.

Spring-activated self-locking mechanism.

Reflective detail trim for increased safety.

Order Code	Description
LUGBOX10	24L Capacity
LUGBOX11	48L Capacity



LUGBOX10



LUGBOX11

## Jumbo Kit Bag

Features

- 130L capacity
- Main storage compartment with dirty kit bag
- 2 end compartments suitable for helmets and boots
- Integral roll-out changing mat
- Travel wheels and retractable trolley handle
- Shoulder straps and carry handles
- 841 x 400 x 400mm



Travel Wheels



Trolley Handle



**130 litres**

Order Code: LUGKITA

## Midi Kit Bag

Features

- 90L capacity
- Main storage compartment with dirty kit bag
- 2 end compartments
- Integral roll-out changing mat
- Shoulder straps and carry handles
- 701 x 350 x 350mm

**90 litres**

Order Code:  
LUGKITB



## Luggage Tool Roll

Tri-folding heavy duty nylon tool roll, featuring dividers and elastic retainers for tool storage. Includes fold out document pouch. 40 x 30cm opened.

**NEW**

Order Code: LUGTLS13



\* Tools not included

## Luggage Protection Web

Anti-slip webbing mat increases grip between luggage and tanks / tail sections. Also prevents scratching and wearing of paintwork. These sheets can be folded to cover the area to be protected, or simply cut to fit for a more precise and detailed cover.

Large - 60 x 90cm

Order Code: LUGWEBL

Small - 30 x 40cm

Order Code: LUGWEBS





## Urbano Tank Bag

- 15 Litre contoured tank bag
- Expands to 23 Litre
- Magnetic fitting to petrol tank
- Zip closing main compartment
- Clear vinyl top allows viewing of maps and printed itineraries
- Zip off base features map pouch
- Main bag converts to rucksack
- Includes rain cover

Order Code: **LUGTNK40**



## Mini Tank Bag

- 7 Litre mini tank bag, contoured shaping
- Magnetic fitting to petrol tank
- Zip closing main compartment
- Front compartment for wallet and keys
- Top phone compartment with clear vinyl window
- Includes rain cover

Order Code: **LUGTNK24**



## Midi Tank / GPS Bag

- 8 Litre mini tank bag, contoured shaping
- Magnetic fitting to petrol tank
- Zip closing main compartment
- Front compartment for wallet and keys
- Pop-up Sat Nav / GPS holder with rubber cable port
- Includes rain cover

Order Code:  
**LUGTNK28**



## Tank Map Pouch

- Magnetic fitting map pouch
- Clear vinyl top allows viewing of maps and printed itineraries

Order Code: **LUGTNK32**



Motocp  
Exhausts  
Screens  
Commuter  
Controls  
Headlights  
Indicators  
Mirrors  
Rear  
Lights  
Lifts &  
Stands  
Tools  
Batteries &  
Chargers  
Electrics  
Chain  
Servicing  
Tyres &  
Tubes  
Security  
Bike  
Accs  
Luggage  
Rider  
Accs  
Tank  
Pads  
Extras

Motor  
 Exhausts  
 Screens  
 Commuter  
 Controls  
 Headlights  
 Indicators  
 Mirrors  
 Rear Lights  
 Lifts & Stands  
 Tools  
 Batteries & Chargers  
 Electrics  
 Chain  
 Servicing  
 Tyres & Tubes  
 Security  
 Bike Accs  
 Luggage  
 Rider Accs  
 Tank Pads  
 Extras  
 www.biketek.co.uk

## Backpack / Helmet Carrier

A sensibly proportioned backpack for motorcycle use  
 Padded shoulder straps  
 Adjustable waist belt for secure fit  
 Main central compartment  
 Two side pockets  
 Features unique inbuilt helmet "cradle" enabling helmet to be stored.

Order Code: **LUGRS12**



## Biketek Waist Bag

Ripstop nylon waistbag comprising main central compartment and two side pouches. Perfect storage for wallets, phones and keys whilst riding.  
 1.6 Litre capacity.

Order Code: **LUGBUM13**

**NEW**



## Bumbag

Deluxe multi compartment nylon bum bag with adjustable waist strap

Order Code: **LUGBUMBLK**



## Waterproof Rucksack Cover

Universal fitting rucksack cover, fits most medium/small sized backpacks.  
 Hi-Vis yellow material with reflective piping for increased on-road safety.  
 Waterproof coated nylon.  
 Outer mesh pocket.

Order Code: **LUGRS11**



## Helmet Carrier

A generous sized storage bag for one helmet plus kit and gloves  
 Central compartment for helmet storage  
 Two side zip pockets  
 Fleece lined for protection  
 Feature ventilation ducts allows kit to breathe and dry  
 Carry handle and hanger-loop

Order Code: **LUGHEL12**



## Biketek Hydration Pack

This Biketek hydration pack is a complete drinks system for use whilst on the move, perfect for green-laning, trail and road riding.  
 The robust backpack features a well-sized main compartment with internal key pocket and a further 3 outer zip pockets, and MP3 headphone port. The 2 litre drinks bladder locates in a separate external section, with drinking-tube retainers on the shoulder straps. External bungee and quick release chassis enables trapping of spare clothing and luggage. Fully padded shoulder straps and back support, with chest and waist belts for snug fitment.



**NEW**

Order Code Description  
**LUGHYD07** Hydration pack with 2L bladder  
**LUGHYD09** Replacement bladder 2L



## Rucksack

Heavy duty nylon rucksack, 2 inner and 2 outer compartments, plus torso strap for extra stability.

Order Code: **LUGRSBLK**





## Emergency LED Hazard Lamp

Battery powered 16 red LED strobe lamp with 9 flash modes

Use as an emergency beacon or breakdown warning.  
9 flash programmes including circular, permanent and strobe effects.  
Integral magnet (for mounting to vehicle surfaces)  
Heavy duty plastic casing  
Hanging loop.  
Small enough to carry under seat or in luggage.  
Simple one button control.  
Requires 2 x AAA batteries (not included).

Order Code: **TLSFLR13**

**NEW**



## Emergency Roadside Kit

In line with European legal requirements, this kit includes a collapsible warning triangle and reflective vest, necessary for road users in event of a breakdown or accident. The kit breaks down into a compact hardshell case and storage bag, ready for packing into luggage and panniers.

Order Code: **REFEME**



## Luggage Anchor Kit

Finding suitable anchor points on some bikes for bunjees and cargo nets can be tricky. Bike It offer three solutions to this, with universal anchor kits that bolt onto bike tail sections. All kits require some drilling of bodywork.

This kit consists of a pair of aluminium threaded stems which bolt into tail sections. Finished with rounded heads, the stems provide a sturdy fixing point for cargo net and bungee hooks.

Order Code: **LUGANCH**



## Luggage Hooks

These robust PC hooks also bolt onto tail sections but have an additional feature of folding away when not in use. The hooks are perfect for anchoring cargo nets and bunjees, as well as hooks from luggage such as tail packs and panniers.

Order Code: **LUGHOOK**

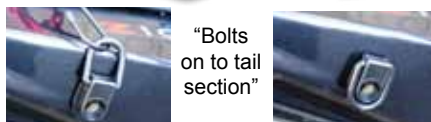

"Bolts on to tail section"

## Luggage Loops

Premium CNC machined alloy luggage hooks. Sold in pairs.

Order Code: **LUGLOOP**



## Cargo Nets

Strong and durable cargo nets, available in 2 sizes.  
Feature coated steel hooks.

Order Code	Size	Hooks	Colour
<b>NETBLK</b>	Medium	6	Black
<b>NETR</b>	Medium	6	Red
<b>NETBU</b>	Medium	6	Blue
<b>NETXBLK</b>	Large	6	Black
<b>NETXLR</b>	Large	6	Red
<b>NETXLBU</b>	Large	6	Blue



## Luggage Elastics

Extra strong bungee straps in different lengths. Available in original steel hook and lockable plastic hook. Packs of 10.

Order Code	Description	Diameter	Length
<b>ELALH24</b>	Lockable head	8mm	24"
<b>ELALH30</b>	Lockable head	8mm	30"
<b>ELALH36</b>	Lockable head	8mm	36"
<b>ELAW18</b>	Steel hook	3/8"	18"
<b>ELAW24</b>	Steel hook	3/8"	24"
<b>ELAW30</b>	Steel hook	3/8"	30"
<b>ELAW36</b>	Steel hook	3/8"	36"



Lockable head

Steel hook

## Helmet Bag

Simple drawstring helmet bag with fleece inner for extra protection.

Order Code	Description
<b>BAGBLK</b>	Plain black



Motocp  
Exhausts  
Screens  
Commuter  
Controls  
Headlights  
Indicators  
Mirrors  
Rear Lights  
Lifts & Stands  
Tools  
Batteries & Chargers  
Electrics  
Chain  
Servicing  
Tyres & Tubes  
Security  
Bike Accs  
Luggage  
Rider Accs  
Tank Pads  
Extras

## Full Face Helmets

Fluoro Arriving  
Spring 2013

NEW

- Contoured feature thermo plastic shell
- Quick-Release retention system
- Air flow inlets to mouth and head
- Air flow outlet at rear of head
- Breath deflector
- ECE2205

Order Code	Style	Size
HEL80XS	Starburst Black / Red	XS
HEL80S	Starburst Black / Red	S
HEL80M	Starburst Black / Red	M
HEL80L	Starburst Black / Red	L
HEL80XL	Starburst Black / Red	XL

HEL82XS	Cosmos White / Red	XS
HEL82S	Cosmos White / Red	S
HEL82M	Cosmos White / Red	M
HEL82L	Cosmos White / Red	L
HEL82XL	Cosmos White / Red	XL

HEL84XS	Cosmos White / Blue	XS
HEL84S	Cosmos White / Blue	S
HEL84M	Cosmos White / Blue	M
HEL84L	Cosmos White / Blue	L
HEL84XL	Cosmos White / Blue	XL

HEL87XS	Warp Black	XS
HEL87S	Warp Black	S
HEL87M	Warp Black	M
HEL87L	Warp Black	L
HEL87XL	Warp Black	XL

HEL88XS	Fluoro	XS
HEL88S	Fluoro	S
HEL88M	Fluoro	M
HEL88L	Fluoro	L
HEL88XL	Fluoro	XL

HEL86GD	Replacement Nose Guard
HEL86L	Replacement Liner Kit Large
HEL86M	Replacement Liner Kit Medium
HEL86S	Replacement Liner Kit Small
HEL86VF	Replacement Front Vent
HEL86VM	Replacement Visor Mounts
HEL86VR	Replacement Rear Vent
HEL86XL	Replacement Liner Kit XL
HEL86XS	Replacement Liner Kit XS
VIS008	Replacement Clear Visor

### Helmet Size Chart

ADULT				
XS	S	M	L	XL
53-54cm	55-56cm	57-58cm	59-60cm	61-62cm



Fluoro



Warp



Warp



Cosmos



Cosmos



Cosmos



Starburst



Starburst

## EURO Open Face Helmets

- Thermoplastic shell with inset carbon fibre effect panels.
- Antiscratch clear polycarbonate visor
- Buckle retention system
- ECER2205
- Weight: 1070g +/- 50g

Order Code	Size
<b>PLAIN SILVER</b>	
HEL18S	Small
HEL18M	Medium
HEL18L	Large
HEL18XL	Extra Large

<b>MATT BLACK</b>	
HEL29S	Small
HEL29M	Medium
HEL29L	Large
HEL29XL	Extra Large

Replacement Clear Visor  
Order Code: VIS002



## Flip-200 Helmets

- Thermoplastic shell
- Mouth and brow inlets
- Antiscratch clear polycarbonate visor
- Removable cheek pads
- Buckle retention system
- ECE2205
- Weight: 1790g +/- 50g

Order Code	Size
<b>TITANIUM GREY</b>	
HEL32S	Small
HEL32M	Medium
HEL32L	Large
HEL32XL	Extra Large

<b>BLACK</b>	
HEL31S	Small
HEL31M	Medium
HEL31L	Large
HEL31XL	Extra Large

Replacement Clear Visor  
Order Code: VIS006



MotoGP  
Exhausts  
Screens  
Commuter  
Controls  
Headlights  
Indicators  
Mirrors  
Rear Lights  
Lifts & Stands  
Tools  
Batteries & Chargers  
Electrics  
Chain  
Servicing  
Tyres & Tubes  
Security  
Bike Accs  
Luggage  
Bridal Accs  
Tank Pads  
Extras  
www.bikeit.co.uk



## BikeTek Action Sports Camera

Fantastic value action sports camera, captures video footage whilst mounted to sports helmets or on-board motorcycles, cycles etc.

This waterproof camera records 640x480 VGA (320x240 QVGA) resolution at 30 frames per second.

Powered by 2 x AA batteries (not supplied) the unit will record for up to 120 minutes (where external memory permits).

64Mb of internal memory can be increased up to 8Gb by use of an SD card (not supplied).

What's included:

- 1.3 Megapixel waterproof Action Sports Camera
- 1 x Pivoting quick-release camera mount
- 1 x Handlebar mount
- 1 x Velcro strap - LONG
- 1 x Velcro strap - SHORT
- 1 x Silicon rubber helmet strap
- 1 x Strap/Adhesive mount
- AV cable for use with TV/PC capture cards
- USB cable
- LCD information panel
- Velcro pads
- Rubber spacer pads
- CD and manual

Order Code: CAM016



**BIKETEK**



**REPLACEMENT BASE**  
Order Code: CAM018



**CLIP MOUNT**  
Order Code: CAM020

## Earplugs in Keyfob Case

Countertop dispenser containing 120 pairs of PU protective earfoams. Each pair of earfoams is supplied in a plastic keyfob canister for easy storage.

Order Code:  
**EARFOAM120**



## Ear Foams

Bag of 25 pairs 'Spark Plugs'

- 35db SNR noise absorption
- CE approved
- Conical shape for extra comfort and improved fit

Order Code: **EARFOAM25**



## Visor Cleaning Fingerbands

4pc pack of fleece fingerbands to wear over gloves. Effectively clears visor of water and grime whilst riding. Wear as many bands as needed, keep clean spares in pocket. Fully washable

Order Code:  
**VCL015**



It is the users responsibility to ensure that fingerbands do not interfere with controls whilst riding.

## Neoprene Helmet Skirt

A neoprene-constructed helmet skirt that attaches to the base of full-face helmets. Skirt reduces windflow and noise, increasing rider comfort. Universal full-face helmet fitting, easily installed and removed. Secures in place by inbuilt non-slip backing.

Order Code: **HELSEKR1**



## Visor Pouch

Durable visor waist pouch with integral belt. Ideal for long journeys where a change between light and dark visors are needed

Order Code Colour  
**LUGVPBLK Black**



Motorcycle  
Exhausts  
Screens  
Commuter  
Controls  
Headlights  
Indicators  
Mirrors  
Rear Lights  
Lifts & Stands  
Tools  
Batteries & Chargers  
Electrics

Chain  
Servicing  
Tyres & Tubes  
Security  
Bike Accs  
Luggage

Rider Accs  
Tank Pads  
Extras

www.bikeit.co.uk

## Road Gloves

### HEAVY WEIGHT WINTER THERMAL (with knuckle protector)

- Waterproof winter glove
- Cowhide and Nylon Cordura construction
- Hard shell protectors on knuckles and fingers
- Material re-inforcements on palm
- Velcro wrist fastener
- Cuff drawstring fastener
- Reflective piping

Order Code	Size
GLVRD09XS	X Small
GLVRD09S	Small
GLVRD09M	Medium
GLVRD09L	Large
GLVRD09XL	XL
GLVRD09XX	2XL



### HEAVY WEIGHT WINTER THERMAL

- Waterproof winter glove
- Sturdy Nylon Cordura construction
- Material re-inforcements on palm
- Velcro wrist fastener
- Reflective piping

Order Code	Size
GLVRD05XS	X Small
GLVRD05S	Small
GLVRD05M	Medium
GLVRD05L	Large
GLVRD05XL	XL
GLVRD05XX	2XL



### TEXTILE WINTER THERMAL

- Waterproof textile road glove
- Reinforced leather palm section
- Reflective piping
- Webbing tab-pull adjuster across wrist
- High cuff for wind protection
- Thermal lining

Order Code	Sizes
GLVRD18S	Small
GLVRD18M	Medium
GLVRD18L	Large
GLVRD18XL	XL
GLVRD18XXL	2XL



### LEATHER / TEXTILE PROTECTOR

- Waterproof mid-weight road glove with dual textile and leather construction
- Floating knuckle protector for increased movement
- Thermal lining
- Velcro adjuster on wrist
- High cuff for wind protection

Order Code	Sizes
GLVRD16S	Small
GLVRD16M	Medium
GLVRD16L	Large
GLVRD16XL	XL
GLVRD16XXL	2XL



MotoGP  
 Exhausts  
 Screens  
 Commuter  
 Controls  
 Headlights  
 Indicators  
 Mirrors  
 Rear  
 Lights  
 Lifts &  
 Stands  
 Tools  
 Batteries &  
 Chargers  
 Electrics  
 Chain  
 Servicing  
 Tyres &  
 Tubes  
 Security  
 Bike  
 Accs  
 Luggage  
 Rider  
 Accs  
 Tank  
 Pads  
 Extras  
 www.bikeit.co.uk



## Road Gloves

### 3 FINGERED HEAVY WEIGHT THERMAL

- Mitten design increases warmth and allows 2 finger clutch and braking
- Textile & leather uppers
- Waterproof
- Reinforced palm
- Velcro wrist & cuff fasteners

Order Code	Size
GLVRD11XS	X Small
GLVRD11S	Small
GLVRD11M	Medium
GLVRD11L	Large
GLVRD11XL	XL
GLVRD11XX	2XL



### SUMMER LEATHER GLOVE

- Leather construction summer road glove
- Reinforced palm section
- Dual velcro fastener under wrist and cuff
- Hardshell protectors on knuckle
- Floating knuckle protector for increased movement
- Air vents on fingers and thumb
- Mid cuff for wind protection
- Thermal lining

Order Code	Sizes
GLVRD20S	Small
GLVRD20M	Medium
GLVRD20L	Large
GLVRD20XL	XL
GLVRD20XXL	2XL



## Road Gloves - Adult

### LEATHER LIGHT WEIGHT ROAD AND RACE GLOVES

- Full cowhide leather
- Hard shell knuckle protectors
- Reinforced palm and finger grip
- Velcro wrist & cuff fasteners
- Reflective piping
- Finger vents

Order Code	Size
GLVRD08XS	X Small
GLVRD08S	Small
GLVRD08M	Medium
GLVRD08L	Large
GLVRD08XL	XL
GLVRD08XX	2XL



## Road Gloves - Youth

### YOUTH LEATHER ROAD GLOVES

- Full leather road-style glove for kids
- Hard shell knuckle protectors
- Reinforced palm and finger grip
- Velcro wrist and cuff fasteners
- Reflective piping
- Finger vents

Order Code	Size
GLVRD08KS	Small #5 (10-12cm), approx age 5-7
GLVRD08KM	Medium #6 (13-14cm) approx age 7-8
GLVRD08KL	Large #7 (15-17cm) approx age 9+



Motocp  
Exhausts  
Screens  
Commuter  
Controls  
Headlights  
Indicators  
Mirrors  
Rear Lights  
Lifts & Stands  
Tools  
Batteries & Chargers  
Electrics  
Chain  
Servicing  
Tyres & Tubes  
Security  
Bike Accs  
Luggage  
Rider Accs  
Tank Pads  
Extras

## Liner Glove

**NEW**

- Lightweight and comfortable liner glove.
- Suitable for use in hot and cold conditions.
- Quick drying wicking material minimises moisture and regulates temperature.
- Extended cuff ensures optimum comfort with summer and winter gloves.

Order Code	Size
GLVINN12S	Small
GLVINN12M	Medium
GLVINN12L	Large
GLVINN12XL	XL



## Windproof Inner Glove

Windproof inner gloves offer increased protection from wind chill. A specialised material on the top sections are windproof and waterproof. The palm section is thermal fleece offering a fantastically warm and dry inner glove.

Order Code	Size
GLVINN01M	Medium
GLVINN01L	Large
GLVINN01XL	Extra Large



## Road Gloves

### CLASSIC FINGERLESS

- Leather construction fingerless glove
- Traditional design
- Velcro fastener on wrist

Order Code	Sizes
GLVRD15S	Small
GLVRD15M	Medium
GLVRD15L	Large
GLVRD15XL	XL
GLVRD15XXL	2XL



## Inner Gloves

Thermal cotton inner gloves offer extra warmth under normal gloves. One size fits all.

Order Code: **GLVBLK**



## Waterproof Over Mittens

Waterproof 2 finger over-mittens for everyday biking use.

Features:

- Constructed from heavy duty nylon and PVC
  - Welded seams
  - Tailored fit elasticated wrist and forearms
- One size fits all

Order Code: **RNW2MIT**





## Men's Challenger Road Jacket

500D abrasion resistant and waterproofed textile fabric, with feature trims. Removable insulated thermal liner. CE approved shoulder and elbow protectors. Foam back protector. Soft-fibre neck padding. Front zip storm flap for wind and rain elimination. Trousers connector zip. Air-flow shoulder ventilation. Single zipped external chest pocket. Two front waist open pockets with velcro-closure pouch pockets. Adjustable webbing waist belt. Yellow and graphite coloured contrast trim. Velcro cuff closure.

Order Code	Size
JKT10S	Small
JKT10M	Medium
JKT10L	Large
JKT10XL	XL
JKT102XL	XXL
JKT103XL	XXXL

**NEW**



## Men's Warrior Road Jacket

500D abrasion resistant and waterproofed textile fabric, with feature trims. Removable insulated thermal liner. CE approved shoulder and elbow protectors. Foam back protector. Soft-fibre neck padding. Front zip storm flap for wind and rain elimination. Trousers connector zip. Air-flow shoulder ventilation. Two velcro closure external chest pockets. Two velcro-closure waist pockets. Adjustable webbing waist belt. Grey and graphite coloured contrast trim. Velcro cuff closure.

Order Code	Size
JKT11S	Small
JKT11M	Medium
JKT11L	Large
JKT11XL	XL
JKT112XL	XXL
JKT113XL	XXXL

**NEW**



## Men's Defender Road Trousers

500D abrasion resistant and waterproofed textile fabric, with feature trims. Removable insulated thermal liner. CE approved knee protectors. Foam hip protectors. Crotch zip storm flap for wind and rain elimination. Jacket connector zip. Two zip closure waist pockets. Single velcro-closure external thigh pouch pocket. Adjustable webbing waist belt. Grey and graphite coloured contrast trim. Zip closure lower legs for easy fitment over boots. Contoured panelling to waist and knee for optimum fit.

Order Code	Size
TRS10S	Small
TRS10M	Medium
TRS10L	Large
TRS10XL	XL
TRS102XL	XXL
TRS103XL	XXXL

**NEW**



Motorcycle  
Exhausts  
Screens  
Commuter  
Controls  
Headlights  
Indicators  
Mirrors  
Rear Lights  
Lifts & Stands  
Tools  
Batteries & Chargers  
Electrics  
Chain  
Servicing  
Tyres & Tubes  
Security  
Bike Accs  
Luggage  
Rider Accs  
Tank Pads  
Extras

## BikeTek Inner Wear

New from the Bike Tek range comes a comprehensive range of base layers offering everything needed for optimum rider comfort in warm and cold weather.

Comfort during riding is proven to minimise rider fatigue and promote better concentration and safer riding. This is achieved simply and effectively by using the correct base layers and combinations.

### Warm weather:

Use the Coolmax product, either leggings and top, or a 1pc inner suit. The product works wonders under leathers and textile garments, the Coolmax material has specialised properties which wicks moisture away from the skin to keep dry, as well as drawing heat away from the body. The breathable Coolmax layer will prevent the rider's skin being in contact with damp leathers or textiles.

### Cold weather.

Use the Thermolite top and leggings. Thermolite material has specialised properties to wick moisture away whilst keeping the body warm. For colder conditions use the Coolmax product under the Thermolite product, adding additional base layers increases heat retention. Base layers use high-performance materials which offer superior warmth and protection in thin layers, avoiding use of bulky garments which prove cumbersome and restrict movement.

## COOLMAX Inner Wear

### Coolmax Top

A close fitting design jersey manufactured from premium Coolmax Active cooling and wicking material. Stretch panelling on sides and under-sleeve optimise fitment. Features chest pocket



### Coolmax Leggings

A close fitting design legging manufactured from premium Coolmax Active cooling and wicking material. Stretch panelling on inner thigh optimises fitment.



### Coolmax Active

- Moisture wicking material, superior wicking performance than nylons, cottons and polyesters.
- Faster drying than other fabrics
- Wicks sweat away from your body
- Keeps you cool, dry and comfortable
- Lightweight, soft and breathable

## COOLMAX 1pc Inner Suit

### 1pc Inner Suit

Manufactured from Coolmax Everyday cooling and wicking material, the 1pc suit is perfect to provide a comfort layer between the skin and leathers or textiles. The mesh material prevents skin chafing whilst regulating moisture and heat retention.

An on-bike contoured cut with stretch panelling on lower back and calf make this a perfect fitting suit. Under-foot straps and thumb-hooks allows easy use even with tight-fitting leathers. 2-way full frontal zip allows easy access for toilet stops.



### Coolmax Everyday

- Moves moisture away from your body
- Fabric dries quickly
- Lightweight, soft and breathable
- Keeps you cool, dry and comfortable



Order Code	SIZE
------------	------

### COOLMAX MESH INNER SUIT

INWS1S	SMALL
INWS1M	MEDIUM
INWS1L	LARGE
INWS1XL	XL
INWS1XX	2XL

Order Code	SIZE
------------	------

### COOLMAX TOP

INWT1S	SMALL
INWT1M	MEDIUM
INWT1L	LARGE
INWT1XL	XL
INWT1XX	2XL

### COOLMAX LEGGINGS

INWL1S	SMALL
INWL1M	MEDIUM
INWL1L	LARGE
INWL1XL	XL
INWL1XX	2XL



## THERMOLITE Inner Wear

Order Code      SIZE

### THERMOLITE TOP

INWT2S	SMALL
INWT2M	MEDIUM
INWT2L	LARGE
INWT2XL	XL
INWT2XX	2XL

### THERMOLITE LEGGINGS

INWL2S	SMALL
INWL2M	MEDIUM
INWL2L	LARGE
INWL2XL	XL
INWL2XX	2XL

### Thermolite Top

A close fitting design jersey manufactured from Thermolite warming and wicking material. Stretch panelling on sides and under-sleeve optimise fitment. Features zipped turtle-neck.

### Thermolite Leggings

A close fitting design legging manufactured from Thermolite warming and wicking material. Stretch panelling on inner thigh and calf optimise fitment.

### Thermolite

- Lightweight insulation for cold weather warmth
- Superior movement of moisture to keep you warmer and dryer
- Patented thermal technology provides warmth with a comfortably soft, lightweight insulation



## Bike It Cosworth Yamaha Racing Paddock Shirts

Official Bike It Cosworth Yamaha Racing teamwear.

Short-sleeved black poly-cotton shirt with feature piping and red panels.

Button down oxford-style collar.

Embroideries on sleeves, chest and back.

Now available in 5 sizes, including 3XL !

Order Code	Size	Chest Inches
SHR011M	Medium	40
SHR011L	Large	42
SHR011XL	XL	44
SHR011X2	2XL	46
SHR011X3	3XL	48



Motocp  
Exhausts  
Screens  
Commuter  
Controls  
Headlights  
Indicators  
Mirrors  
Rear  
Lights  
Lifts &  
Stands  
Tools  
Batteries &  
Chargers  
Electrics  
Chain  
Servicing  
Tyres &  
Tubes  
Security  
Bike  
Accs  
Luggage  
Rider  
Accs  
Tank  
Pads  
Extras

## Kit Care

### LEATHER CARE

Leather is arguably the best material used in motorcycle protective clothing, Bike It offer this great range of leather care products to maintain and preserve garments, gloves, boots and even luggage.



### LEATHER CONDITIONING CREAM 100ml

This wax based conditioning cream is mixed with Carnauba wax to improve water repellency and durability. Performs by waterproofing leather as well as nourishing.

Order Code: **CPT019**



### LEATHER SOAP 350g

The original method of cleaning and caring for smooth leathers, this product uses pure ingredients including natural vegetable soaps. Also contains glycerine conditioner to maintain supple leather.

Order Code: **CPT011**



### LEATHER ENHANCER 250ml

This wax waterproofing spray reconditions, rejuvenates and nourishes leather. The soft consistency allows deep absorption and prevents leather from becoming brittle. Offers high level of water and dirt repellency. Simple spray on / wipe off application.

Order Code: **CPT017**



### LEATHER SPONGE

This sponge is designed for use in leather cleaning by means of a patented non-scratch surface, which when damp, loosens dirt and deposits without damaging the leather. Perfect for use with leather soap.

Order Code: **CPT015**

### HELMET & BOOT CARE



### ANTI-FOG

Improves visibility for safer riding by preventing misting and fogging on the inside of visors. Apply with a soft cloth.

Order Code: **CPT005**



### KIT DEODORANT

Helmets & boots are notorious for accumulating bacteria and nasty odours. This silver based anti-bacterial solution kills off bacteria and actively resists further bacterial growth. Simply spray inside boots and helmets to kill off odours and keep kit fresh.

Order Code: **CPT001**



### VISOR REPELLENT

Creates a non-stick coating to force rain to bead and run off aerodynamically. Simply apply with a soft cloth for miles of clear visor riding.

Order Code: **CPT003**

### TEXTILE CARE

All textile clothing is waterproofed by the manufacturer using a coating spray or solution. Over time and under normal usage these waterproof barriers deteriorate and cause the material to allow water to pass through.

### TEXTILE WATER-PROOFER & PROTECTOR 250ml

Order Code: **CPT009**



### ANTI-BAC CLEANER

Textile clothing when worn regularly will accumulate bacteria and start to smell unpleasant over time.

Machine washing is the best option for cleaning textiles but normal household washing detergents can damage waterproofed and technical materials.

This neutral pH bespoke detergent cleaner that kills bacteria whilst not affecting materials, leaving kit refreshed and revitalised. Can be used for hand-washing, see label for full instructions.

Order Code: **CPT007**



Motocp  
Exhausts  
Screens  
Commuter  
Controls  
Headlights  
Indicators  
Mirrors  
Rear Lights  
Lifts & Stands  
Tools  
Batteries & Chargers  
Electrics  
Chain  
Servicing  
Tyres & Tubes  
Security  
Bike Accs  
Luggage  
Bridal Accs  
Tank Pads  
Extras  
www.bikeit.co.uk



## Sam Browne Reflective Belt

**NEW**

The timeless and original Sam Browne style safety belt. Features crystalline reflective tape mounted on a robust nylon webbing strap, oversize buckle for ease of use with gloved hands, fully adjustable on the waist and shoulder.

Order Code: **REFBWN**



## Reflective Brace

High visibility brace, made from crystalline reflective tape, as used by British police and emergency services. Features waist belt with 2 shoulder straps, fully adjustable to fit all sizes! Waist and chest bands use large size click buckles, easy to use even with gloves on.

Order Code: **REFBRC**



## Reflective Over Jacket

A superior high visibility product, the 3/4 length sleeves offer additional safety and visibility, especially from the side and in heavy traffic. Features white reflective crystalline tape as used by the British police and emergency services.

Features:

- Generous cut
  - Zip front
  - Hi-Vis reflective crystalline tape
  - 3/4 Length sleeves
  - Lightweight - fits over existing clothes
- One size fits all.

Order Code: **REFJACK**



## Reflective Bib Vest

High visibility bib-vest for increased safety. Bright colours and reflective tape helps other road users see riders both day and night.

Features:

- Generous cut for comfort
  - Strong zip fastening front
  - EN471/EN340 "Hi-Vis" tape
- One size fits all.

Order Code Description  
**REFVEST** Yellow  
**REFVORG** Orange



## Urban Hi-Vis Gilet

A robust premium hi-vis garment for wearing over motorcycle jackets. Manufactured from tough Oxford material with mesh lining.

Hi-vis yellow colour with reflective trim for increased on-road visibility.

Features lower back zip-pocket with overflap, waist pockets and zipped chest-pocket.

Fully adjustable 'floating' sides for optimum fitting.

Order Code Size  
**REFGLT11** Medium  
**REFGLT12** Large / XL



## Commute Hi-Vis

A hard-wearing hi-visibility gilet for wearing over motorcycle jackets.

Manufactured from durable nylon with inner mesh lining.

Jumbo front zip.

Highly visible yellow colour with reflective piping and trim detail.

Stretch side panels ensure comfort fit without baggy feeling.

2 internal pockets.

Order Code Size  
**REFGLT14** Small / Medium  
**REFGLT15** Large  
**REFGLT16** XL / 2XL



Motorcycle  
 Exhausts  
 Screens  
 Commuter  
 Controls  
 Headlights  
 Indicators  
 Mirrors  
 Rear Lights  
 Lifts & Stands  
 Tools  
 Batteries & Chargers  
 Electrics  
 Chain  
 Servicing  
 Tyres & Tubes  
 Security  
 Bike Accs  
 Luggage  
 Rider Accs  
 Tank Pads  
 Extras

MotoGP  
 Exhausts  
 Screens  
 Commuter  
 Controls  
 Headlights  
 Indicators  
 Mirrors  
 Rear Lights  
 Lifts & Stands  
 Tools  
 Batteries & Chargers  
 Electrics  
 Chain  
 Servicing  
 Tyres & Tubes  
 Security  
 Bike Accs  
 Luggage  
 Rider Accs  
 Tank Pads  
 Extras  
 www.bikeit.co.uk

## 1pc Rainsuit

Deluxe 1pc rain oversuit.  
 Optimum contour fit for comfort when riding.  
 Fleece lined, Velcro fastening collar.  
 Diagonal jumbo zip front with Velcro storm flap.  
 Elasticated waist, cuffs and ankles.  
 Velcro fasteners with webbing tabs on cuffs and ankles.  
 Jumbo zip ankle gussets.  
 Reflective piping trim.  
 External chest pocket with storm flap.

Order Code	Size
<b>RNW1PEM</b>	Medium
<b>RNW1PEL</b>	Large
<b>RNW1PEXL</b>	XL
<b>RNW1PEXX</b>	2XL



## Rain Jacket

Deluxe rain over-jacket.  
 Generous fit for comfort when riding.  
 Velcro fastening collar.  
 Jumbo zip front with Velcro storm flap.  
 Elasticated waist and cuffs.  
 Adjustable waist webbing belt.  
 Velcro fastening cuffs with webbing tabs.  
 Reflective piping trim.  
 External chest and waist pockets with storm flaps.

Order Code	Size
<b>RNWJKEM</b>	Medium
<b>RNWJKEL</b>	Large
<b>RNWJKEXL</b>	XL
<b>RNWJKEXX</b>	2XL



## Rain Trouser

Deluxe rain overtrousers.  
 Generous fit for comfort when riding.  
 Elasticated waist and ankles.  
 Velcro fastening ankles with webbing tabs.  
 Jumbo zip ankle gussets.  
 External thigh pocket with storm flap.

Order Code	Size
<b>RNWTREM</b>	Medium
<b>RNWTREL</b>	Large
<b>RNWTREXL</b>	XL
<b>RNWTREXX</b>	2XL



## Waterproof Over Jacket

Deluxe lightweight waterproof overjacket for everyday biking use.

- Constructed from heavy duty nylon & PVC
- Dual tab front zip, with storm proof velcro-closing flap
- 6-way pocket system with velcro-closures
- Taped and welded inside seams
- Generous cut for comfort
- Fleece insulated neck with velcro fastener
- Bungee adjustable rainhood built into neck
- Reflective "Hi-Vis" tape
- Reinforced shoulder and elbow panels
- Dual-cuff protection - elasticated inner cuff and velcro closing outer cuff
- Tailored elasticated waist with adjustable buckled strap
- Bunjee adjustable hem
- Mesh and Nylon combination lining

Order Code	Size
<b>RNWJAKAL</b>	Large
<b>RNWJAKAX</b>	Extra Large



## V2 Visor Cleaner

A pocket-sized visor cleaner kit including specialised micro-cell sponge, water-tight storage bag and lint-free cloths.

When damp, the sponge brilliantly cleans visors of bugs and grime, without the use of any soaps or solvents.

Includes a water-tight storage bag to allow user to keep the sponge moist and ready, plus lint-free cloths for drying.

Order Code	Description
<b>VCL001</b>	1 x V2 sponge
<b>VCL005</b>	5 x V2 sponge
<b>VCL010</b>	10 x V2 sponge



## Helmet Visor Cleaner

Handy compact cleaning fluid bottle with pump spray, rubber grime blade and sponge.

Order Code: **VCL**





## Neck Tube

A selection of thermal neck tubes for motorcyclist use, ensuring warmth and wind protection whilst riding. Choose from original poly-cotton and new heavy-weight thermal.

Order Code	Colour
<b>NTUBLK</b>	Black poly-cotton
<b>NTUR</b>	Red poly-cotton
<b>NTUBU</b>	Blue poly-cotton
<b>NTUTH</b>	Black heavy-weight



NTUBLK



NTUTH

## Easy Masks

Stretch to fit cotton/lycra neck tube, also simply pulls up over your nose to act as a facemask.

Order Code	Colour
<b>FMAEBLK</b>	Black
<b>FMAEBU</b>	Blue
<b>FMAER</b>	Red



## Balaclavas

Double-seamed selection of balaclavas in thermal cotton and cool synthetic silk.

Order Code Description

<b>BALTH</b>	Thermal cotton black
<b>BALSILK</b>	Synthetic Silk black
<b>BAL2EYE</b>	Thermal cotton black double eye-hole



## Deluxe Balaclava

Deluxe balaclava, features windproof and waterproof lower section to offer optimum protection and warmth for neck and face. Crown section is made from lightweight breathable material for comfort.



Order Code:  
**BALWPF**

## Urban Face Mask

Neoprene face masks with integral pollution filters. Nose clip adjusts for perfect fitting.

Order Code: **FMAURBBLK**

### REPLACEMENT FILTERS

Order Code: **FMAFIL**



## Neoprene Face Masks

Neoprene face masks offer protection from the wind and cold, as well as the odd stray bug. Available in standard neck and longer extended bib type.

Order Code	Colour	Size
<b>FMASBLK</b>	Black and grey	Standard
<b>FMABBLK</b>	Black and grey	Long bib
<b>FMABRB</b>	Red and blue	Long bib



## Coolmax Helmet Liner / Remover

This coolmax product acts as a helmet liner to keep rider's head cool and dry. Featuring "handle cut outs" on sides to make removing helmet easier (which fold under chin when riding). Used in Japan as an aid to safely removing helmet from fallen rider.

Order Code:  
**BALKAM**



## Coolmax Helmet Liner

Coolmax material utilises a four-channel fibre that draws moisture to the outer surface, where it is quickly evaporated. This proven moisture management material wicks sweat away from the body and allows air to pass through, keeping the user drier and more comfortable. Adult freesize.

Order Code:  
**BALHEL**



Motorcycle  
Exhausts  
Screens  
Commuter  
Controls  
Headlights  
Indicators  
Mirrors  
Rear Lights  
Lifts & Stands  
Tools  
Batteries & Chargers  
Electrics  
Chain  
Servicing  
Tyres & Tubes  
Security  
Bike Accs  
Luggage  
Rider Accs  
Tank Pads  
Extras

## Motorcyclist Braces

Heavyweight elasticated Braces, designed specifically for use with motorcycle leather and textile trousers.

- Extra-wide Durable Elastic
- Adjustable straps
- Reinforced Seams
- Robust metal Toothed Clips

Order Code Colour

**BRCBLK** Black

**BRCBU** Blue

**BRCR** Red



## Waterproof Overboots

Moulded rubber overboots simply fit over normal biking footwear. 100% waterproof.

Order Code Size

**OVBXS** Extra Small

**OVBS** Small

**OVB** Medium

**OVBL** Large

**OVBXL** X Large

**OVBXXL** XX Large



Waterproof over-boots for everyday biking use.

Features:

- Constructed from heavy duty nylon and pvc
- Welded seams
- Tailored fit elasticated ankles and calves
- Reinforced sole
- Durable inside leg zip, with storm proof velcro-closing flap
- Reflective "Hi-Vis" tape

Order Code Size

**RNWOVBAM** Medium

**RNWOVBAL** Large

**RNWOVBAX** Extra Large



## Pillion Buddy

An updated version of the ever-popular Pillion Grippers.

This new 'Pillion Buddy' design features a torso-pad fitted with comfort moulded handle-grippers and waist-belt buckles.

The rider can wear the torso-pad on either the front or back, allowing more comfortable and secure pillion riding. Waist belt is fully adjustable for most sizes of riders.

Order Code: **LUGBUD**



**NEW**

## Pillion Grippers

Creates holding points for pillion riders. Worn by the rider, this webbing waist belt has a handle-grip on each side for the pillion to grab hold of. The belt is fully adjustable and features a large Kwik-Klik buckle. Perfect for bikes without grab rails or straps.

Order Code: **LUGPIL**



## Neoprene Knee Warmers

These neoprene knee warmers can be worn underneath or on top of motorcycle jeans and pants, providing knee protection from cold and wind.

- Provides warmth and support to knees
  - Universal fit and adjustability with velcro closure
  - Ideal for commuting and touring
  - Hand washable
- Pair

Order Code: **WRMK09**



## Neoprene Waist Warmer

Designed to be worn under motorcycle jackets, providing protection from lower back exposure due to jacket rising when in riding position.

- Provides warmth and support to lower back
- Fleece lined for increased warming
- Velcro closure fits 30" to 40" waist
- Hand washable

Order Code: **WRMW18**



MotoGP  
Exhausts  
Screens  
Commuter  
Controls  
Headlights  
Indicators  
Mirrors  
Rear Lights  
Lifts & Stands  
Tools  
Batteries & Chargers  
Electrics  
Chain  
Servicing  
Tyres & Tubes  
Security  
Bike Accs  
Luggage  
Bridal Accs  
Tank Pads  
Extras  
www.bikeit.co.uk



## Mini First Aid Kit

Comprehensive first aid kit containing many essential emergency items, including: Various bandages, emergency blanket, surgical tape, tweezers and scissors, sterile gloves, plasters, safety pins and cleaning wipes.

Supplied in storage bag with velcro securing loop, which fits compactly into luggage or motorcycle - a legal requirement in many EU countries.

Order Code: **AIDKIT01**



## "Vox Box" Rider-to-Pillion Intercom + Music Player Interface

This mini sized motorcycle intercom kit offers 2-way communication between rider and pillion, operating on a continuous "open channel" makes its use hands-free. Vox-Box also offers a "music line-in" option to plug-in MP3, CD players and Personal Stereos. The ear-piece fits snugly into the ear, the microphone design filters out wind-rush and the flexi-boom allows the microphone to be positioned correctly to the user's mouth.

- Intercom and Music Player
- Simple fitting and connection
- Hands free operation
- Volume control
- Comfort fit in-the-ear earphones
- Flexi-boom microphone
- Mini size module with belt buckle
- Battery operated (2 x AAA batteries not supplied)

Order Code: **TARVOX**



## "Chatterbox" Rider-to-Pillion Intercom

This compact motorcycle intercom kit allows uninterrupted 2-way communication between rider and pillion. Operating on a continuous "open channel" there are no answer or transmit buttons to press. The ear-piece/microphone boom simply clips onto the shell of all helmet types. The flexi-boom ensures optimum positioning of the microphone to the rider's mouth, the ear-piece fits flush in the ear for extra comfort when putting on and wearing crash helmet.

- Simple fitting and connection
- Hands free operation
- Volume control
- Comfort fit in-the-ear earphones
- Flexi-boom microphone
- Fits all styles of helmet
- Compact size module with belt buckle
- Battery operated (4 x AAA batteries not supplied)

Order Code: **TARCHAT**



## Crystal Heatpads

Re-usable hand warmers (pair).

- Simple and safe chemical reaction radiates warmth for over an hour
- Flexing the contained metal disc heats the pads to 50°C within seconds
- Ideal for all outdoor pursuits especially motorcycling and touring
- Rechargeable and reuseable more than 1000 times
- Can be placed inside clothing to warm any part of the body

Order Code: **HEATPAD01**



MotoGP  
 Exhausts  
 Screens  
 Commuter  
 Controls  
 Headlights  
 Indicators  
 Mirrors  
 Rear Lights  
 Lifts & Stands  
 Tools  
 Batteries & Chargers  
 Electrics  
 Chain  
 Servicing  
 Tyres & Tubes  
 Security  
 Bike Accs  
 Luggage  
 Rider Accs  
 Tank Pads  
 Extras  
 www.bikeit.co.uk

## Gripper Tank Pads

Tank pad protector sheets with feature raised nodules, increases grip against petrol tank. Specially designed shape to optimally fit all tanks.

Order Code	Colour
TPPRT08	Transparent
TPPRT10	Black

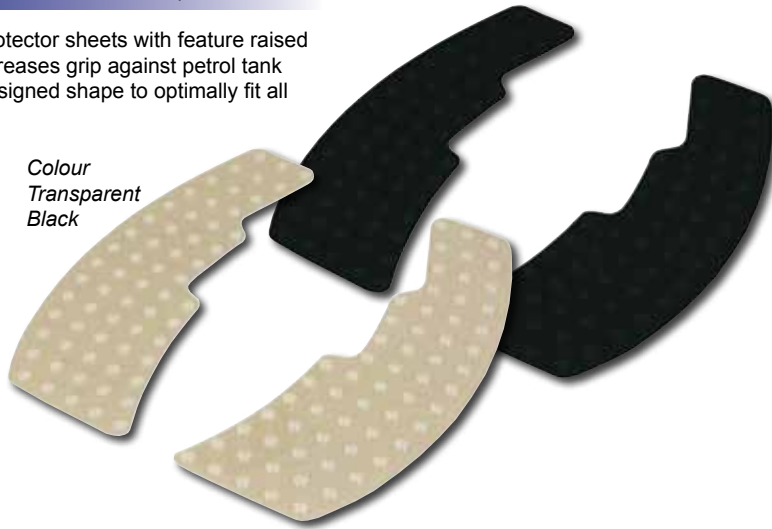

## Bumper Studs

16pc pack of self-adhesive bumper studs. Protects bodywork from knocks and bumps. Chromed stud set on a rubber base. 23mm Diameter.

Order Code: **TPUCOWL**



## Fuel Cap Decal

Carbon look self adhesive fuel cap covers. Each set comprises of fuel cap, keyflap and surround decals.

Order Code	Description
FCCU3A	Aprilia (6 hole)
FCCB3A	BMW (no holes)
FCCU3A	Cagiva (6 hole)
FCCD2A	Ducati (Multistrada - 749 - 999)
FCCD3A	Ducati (5 hole)
FCCH3A	Honda (7 hole)
FCCK3A	Kawasaki >99 (7 hole)
FCCK3B	Kawasaki 00> (5 hole)
FCCK3C	Kawasaki 06>
FCCS3A	Suzuki 00> (7 hole)
FCCS4B	Suzuki 03> (5 hole)
FCCU3A	Triumph (6 hole)
FCCY3A	Yamaha >99 (7 hole)
FCCY3B	Yamaha 00> (5 hole)

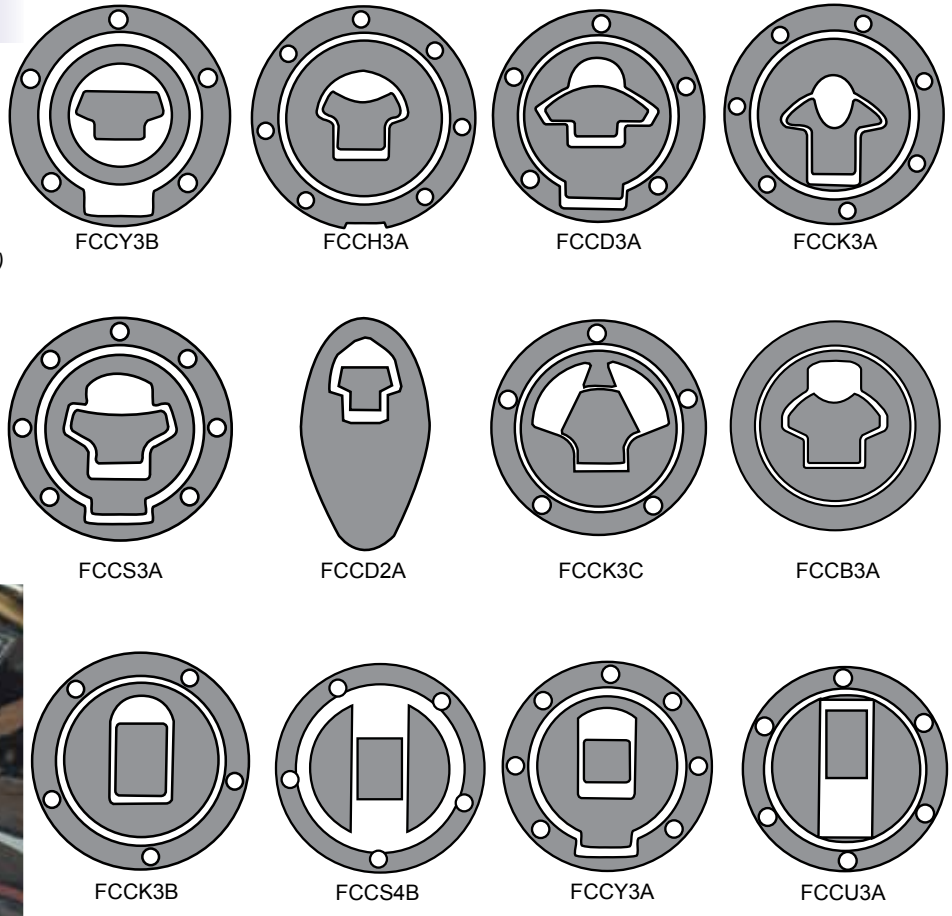

## 'Metal Slash' Spine Tank Pads

Order Code	Description
TPUSPCHQ	Chequered metal slash spine



## Japanese Wrap Tank Pads

Unique styling 4pc "Wrap" tank pad depicting Japanese symbols. Laminate printed design in super-gloss material, ultra sticky adhesive backing ensures secure fit. 4pc set allows perfect tank coverage.

Order Code: **TPUWRPJAP**





## 'Carbon Flash' Spine Tank Pads

Stylish spine tank pads, laminate printed designs in super-gloss material. Ultra-sticky adhesive backing ensures secure fit. All tank pads come complete with 6 extra sticky-tabs for additional tank protection.

Order Code Description

TPHSP03 CBR

TPKSP03 ZXR

TPSSP03 GSXR

TPYSP03 YZF-R

All tank pads come complete with 6 extra sticky-tabs



## Shadow Spine Tank Pads

Order Code Description

TPDSP09 Ducati

TPHSP09 Honda

TPKSP09 Kawasaki

TPSSP09 Suzuki

TPYSP09 Yamaha

TPASP09 Aprilia



## Coloured Spine Tank Pads

New shape spine tank pad available in 4 plain OEM colours.

Order Code Colour

TPUSPY Yellow

TPUSPR Red

TPUSPGN Green

TPUSPBU Blue

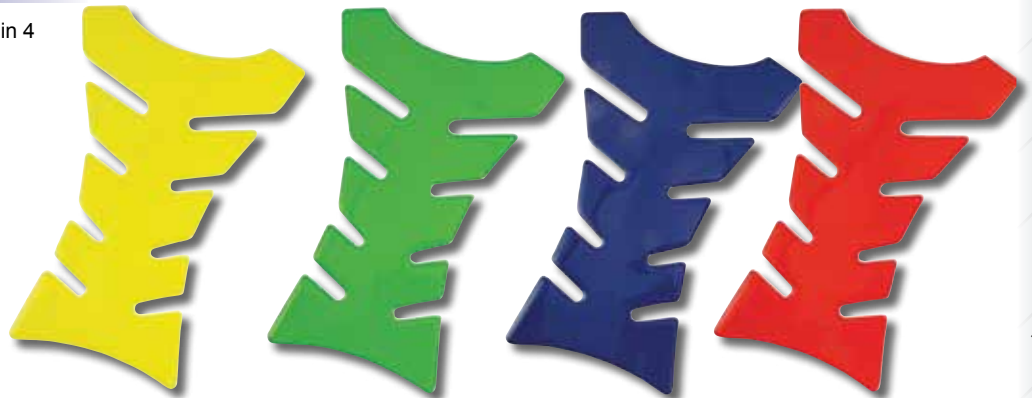

## Spine Tank Pads

Order Code Description

TPUMIDI Transparent midi

TPUSPT Transparent spine

TPUSPBLK Black spine

TPCSP Carbon look spine



Motocp  
Exhausts  
Screens  
Commuter  
Controls  
Headlights  
Indicators  
Mirrors  
Rear Lights  
Lifts & Stands  
Tools  
Batteries & Chargers  
Electrics  
Chain  
Servicing  
Tyres & Tubes  
Security  
Bike Accs  
Luggage  
Rider Accs  
Tank Pads  
Extras

## Logo Spine Tank Pads

Order Code	Description
TPDSP	Ducati carbon look
TPHSP	Honda carbon look
TPKSP	Kawasaki carbon look
TPSSP	Suzuki carbon look
TPYSP	Yamaha carbon look



## 'Cut Your Own' Tank Pads

45x33cm adhesive protector sheet.  
 Protects road bike tanks, bodywork and framework from abrasion.  
 Use on off-road bikes as panel backgrounds.  
 Cut to required shape and size.

Order Code	Colour
STKBAK02	Transparent
STKBAK04	Carbon Effect
STKBAK06	Black
STKBAK08	White
STKBAK10	Red
STKBAK12	Yellow

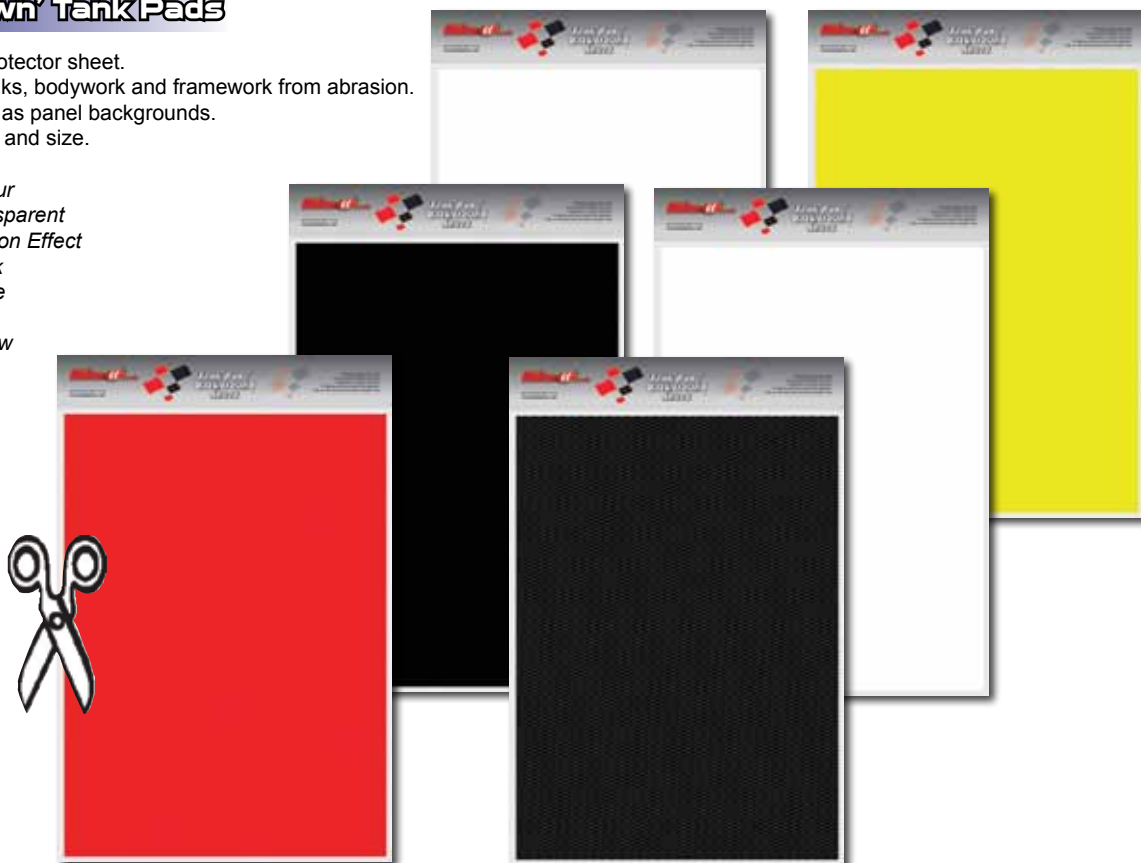

## Protection Packs

Order Code	Description
TPCSPO	Carbon look spots & stripes 20 pack
TPPROT	Transparent protection pack
TPCPR0T	Carbon look protection pack



TPPROT



TPCSPO  
(10 spots & 10 stripes)

TPCPR0T

## Spots and Strips Protector Packs

Tank protector packs of ultra-sticky laminated spots and strips  
 Can locate onto metal and plastic to protect from knocks and abrasion  
 Each pack contains 12pcs spots and 12pcs strips

Available in 3 finishes

Order Code	Colour
TPPRT02	Black
TPPRT04	Clear
TPPRT06	Carbon Effect





## Parking Signs

Novelty aluminium parking signs with drilled screw holes.

Size: 205mm x 290mm

Order Code Description

- SIG001 Biker Zone Only - Enter at own risk
- SIG003 Beware Of The Biker
- SIG005 Beware Of The Biker Bitch
- SIG007 Superbike Parking Only
- SIG009 Scooter Parking Only
- SIG011 Chopper Parking Only
- SIG015 Off Roaders Only
- SIG019 Honda Parking Only
- SIG021 Kawasaki Parking Only
- SIG023 Suzuki Parking Only
- SIG025 Yamaha Parking Only
- SIG027 Ducati Parking Only
- SIG029 Bike It Products...
- SIG031 MV Agusta
- SIG033 Aprilia
- SIG035 Triumph



## Sticker Set

2 A4 sheets of stickers of all the Bike It exclusive products and brands.

These stickers are printed on diecut white backing, perfect for customising fairings, screens and more....

Order Code: **STKSET01**



## Country Flags

Size: 60cm x 90cm

Order Code Description

- FLG001 Union Jack
- FLG002 USA
- FLG003 Scotland
- FLG004 St George



## Tailgater Sticker Set

Ever wanted to let car and van drivers know what you really think of them? Wanted to shout at them to get out the way, watch out for bikers!

This sticker kit features reversed lettering and numbers that when viewed in a car's rear view mirror, reads correctly.

The kit consists of 3 sheets of stickers, letters, numbers and symbols to arm you with the necessities to get your message across!

Order Code:  
**STKSET03**



View in a car rear view mirror



Motocp  
Exhausts  
Screens  
Commuter  
Controls  
Headlights  
Indicators  
Mirrors  
Rear Lights  
Lifts & Stands  
Tools  
Batteries & Chargers  
Electrics  
Chain  
Servicing  
Tyres & Tubes  
Security  
Bike Accs  
Luggage  
Rider Accs  
Tank Pads

EXTRAS



## Paddock Chairs

These superb quality rider chairs are the ultimate rider accessory. As used by professional riders in garages and pits, these team coloured chairs will look great at home, in offices and on the shop floor.

- Unique styling rider's paddock chair
- Deep support seat and back utilising memory foam
- Durable construction and high detail stitching
- Integrated shoulder and thigh supports
- Fully adjustable tilt and recline action
- Pneumatic height adjuster
- Vinyl upholstery
- Chromed base with 5 swivel casters

Order Code:	Description
CHRTEM27	Aprilia
CHRTEM03	Ducati
CHRTEM06	Honda
CHRTEM09	Kawasaki
CHRTEM12	Suzuki Silver & Blue
CHRTEM21	Suzuki Yellow & Blue
CHRTEM15	Yamaha
MGPCHR01	MotoGP



MotoGP  
Exhausts  
Screens  
Commuter  
Controls  
Headlights  
Indicators  
Mirrors  
Rear Lights  
Lifts & Stands  
Tools  
Batteries & Chargers  
Electrics  
Chain  
Servicing  
Tyres & Tubes  
Security  
Bike Accs  
Luggage  
Rider Accs  
Tank Pads  
Extras



## Kit Shelf

Wall mounted shelving unit designed specifically for easy and safe storage of helmet, gloves and clothing. Features helmet shelf, glove shelf and garment rail.

Order Code: **SHL001**



## Event / Workshop Table

Versatile blown plastic moulded table with folding feature. Ideal for additional work space in workshops and outdoor events.

Size: 1830mm x 760mm x 740mm (open)

Order Code: **CHREVT04**

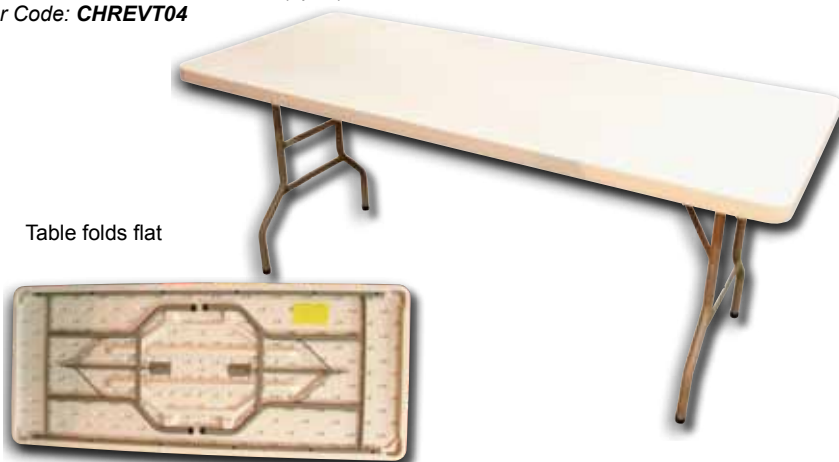

## Bike It Jumbo Stickers

Oversized contour cut jumbo decals, suitable for showrooms and vehicles.

Order Code	Description	Approx Size
<b>STKSET05</b>	Bike It	56x15cm
<b>STKSET07</b>	Biketek	56x6.5cm
<b>STKSET09</b>	Viper Race Cans	52x21.5cm
<b>STKSET11</b>	Airblade Racing Screens	56x15cm
<b>STKSET15</b>	GP Pro	56x7cm
<b>STKSET17</b>	Armstrong	55x10.5cm
<b>STKSET19</b>	Filtrex	56x10.5cm
<b>STKSET21</b>	MotoGP	39x22.5cm
<b>STKSET23</b>	Triple S Chains	28x28cm



## Doormats

Novelty entrance mats for use at home or in showrooms. Non-slip backing with rugged printed top section. Size: 400mm x 600mm

Order Code	Description
<b>DRM002</b>	Honda
<b>DRM004</b>	Kawasaki
<b>DRM006</b>	Suzuki
<b>DRM008</b>	Yamaha



MotoGP  
Exhausts  
Screens  
Commuter  
Controls  
Headlights  
Indicators  
Mirrors  
Rear Lights  
Lifts & Stands  
Tools  
Batteries & Chargers  
Electrics  
Chain  
Servicing  
Tyres & Tubes  
Security  
Bike Accs  
Luggage  
Rider Accs  
Tank Pads  
Extras

MotorGP  
 Exhausts  
 Screens  
 Commuter  
 Controls  
 Headlights  
 Indicators  
 Mirrors  
 Rear Lights  
 Lifts & Stands  
 Tools  
 Batteries & Chargers  
 Electrics  
 Chain  
 Servicing  
 Tyres & Tubes  
 Security  
 Bike Accs  
 Luggage  
 Rider Accs  
 Tank Pads  
 Extras

## Garage Mats - Logo Series 2



Range of bold and striking garage mats, in factory colour-coded designs

Garage mats can be used for decoration and display purposes in home garages and dealer showrooms

Mats also function as protective work-mats both indoors and outdoors, preventing fuel and lubricant spills on floor when carrying out maintenance and repairs

Each mat is constructed with nylon-fibred mat top section which is oil and water resistant, and features a non-slip backing

Size 183cm x 75cm

Order Code	Description
GRGMAT19	Aprilia
GRGMAT20	Ducati
GRGMAT21	Honda *
GRGMAT22	Kawasaki *
GRGMAT24	Mv Agusta *
GRGMAT25	Suzuki Blue *
GRGMAT26	Suzuki Yellow *
GRGMAT27	Triumph
GRGMAT28	Yamaha *



### Garage Mat & Door Mat Combo!

Add a BikeTek Door Mat to any garage mat marked \* above

Money saving set includes one garage mat and one matching door mat

Just add 'SET' to the end of the Order Code above





## Garage Mats - Bike Series 2

Range of bold and striking garage mats, in factory colour-coded designs

Garage mats can be used for decoration and display purposes in home garages and dealer showrooms

Mats also function as protective work-mats both indoors and outdoors, preventing fuel and lubricant spills on floor when carrying out maintenance and repairs

Each mat is constructed with nylon-fibred mat top section which is oil and water resistant, and features a non-slip backing

Size 183cm x 75cm

Order Code	Description
<b>GRGMAT34</b>	Ducati bike
<b>GRGMAT35</b>	Honda bike *
<b>GRGMAT36</b>	Kawasaki bike *
<b>GRGMAT37</b>	Suzuki bike *
<b>GRGMAT38</b>	Yamaha bike *

GRGMAT35



GRGMAT34



GRGMAT38

GRGMAT37

GRGMAT36

Non-Slip Backing

### Garage Mat & Door Mat Combo!

Add a BikeTek Door Mat to any garage mat marked \* above

Money saving set includes one garage mat and one matching door mat

Just add 'SET' to the end of the Order Code above



- Motocp
- Exhausts
- Screens
- Commuter
- Controls
- Headlights
- Indicators
- Mirrors
- Rear Lights
- Lifts & Stands
- Tools
- Batteries & Chargers
- Electrics
- Chain
- Servicing
- Tyres & Tubes
- Security
- Bike Accs
- Luggage
- Rider Accs
- Tank Pads
- Extras

## Easy-Up Gazebos

Free-standing gazebos for occasional use, ideal for weekend track use whether off-road or tarmac, provides a sheltered area for rest and working on bikes. Scissor-style powder coated steel frame allows for simple and quick set-up. Height adjustable support legs, peaked roof prevents rain water build up. Strong waterproofed nylon fabric roof.

Each gazebo is supplied as a frame and roof-only format. Side walls are available to purchase separately, attaching to the roof structure by robust velcro trims.

Order Code	Description
GAZ002	3x3m square gazebo frame and roof
GAZ004	3m width side wall for GAZ002 (1pc)
GAZ006	3m diameter hexagon gazebo frame and roof
GAZ008	2m width sidewall for GAZ006 (1pc)

**NEW**

Arriving  
Spring 2013



Shown with sidewall



GAZ002



GAZ006

## Quick-Up Awnings

These robust free-standing canopies are ideal for any outdoor events including race days and retail shows. Extremely easy to set up, the awning has removeable side walls to protect people and belongings from the elements. A perfect base set up in minutes.

- Powder coated steel frame (30\*30mm)
- Peaked roof for water drainage
- Quick set-up canopy
- Height adjustable upright posts
- Roof and sidewalls 420D PU coated poly fabric
- Sidewalls include windows on 2 sides
- Waterproof, fire retardant and UV protective
- Sidewalls attach to roof with velcro, & zip together for optimum stability
- Light and portable carry bags for sidewalls and frame

Order Code	Description
AWN001	3 x 3m Quick-Up Awning Red
AWN002	3 x 6m Quick-Up Awning Red



Quick-Up canopy



Guy rope attachment



Main picture: 3m x3m. Inset picture 6m x 3m

MotoGP  
Exhausts  
Screens  
Commuter  
Controls  
Headlights  
Indicators  
Mirrors  
Rear Lights  
Lifts & Stands  
Tools  
Batteries & Chargers  
Electrics  
Chain  
Servicing  
Tyres & Tubes  
Security  
Bike Accs  
Luggage  
Rider Accs  
Tank Pads  
Extras  
www.bikeit.co.uk



## Alcohol Breath Tester

Drinking and riding or driving is a serious matter, ideally nobody should drink and then take control of a vehicle, but in reality many of us do. This little device will help you make an informed decision whether or not to ride a bike (or drive a car) after you've had an alcoholic drink. The current UK guidelines\* state a threshold of 80mg of alcohol per 100ml of blood, often referred to as a BAC (Blood-Alcohol Concentration), in this case 0.08%. This device has 3 LED indicators detailing the BAC of the user's breath sample, the LED's use a traffic light sequence to show if the user is safe to drive a vehicle or not.

GREEN = sample below 0.05% BAC > OK to ride

YELLOW = sample over 0.05% BAC > Borderline case, recommendation not to ride

YELLOW & RED = sample over 0.08% BAC > Do NOT ride

Encased in a small unit key-fob, there is no reason ever to be without this essential tool, it might save you your license! Additional features included in the unit; LED torch and clock with countdown timer and stopwatch.

Order Code: **ALCTST01**



This unit must only be used as a guideline to the user's alcohol concentration, it cannot be relied upon to be calibrated to Police and local authorities equipment. No responsibility can be accepted by the manufacturer or supplier in cases where the user is found to be in excess of the legal limits. \* Information correct at time of going to press.

## Motorsports Stopwatch

Professional sports timing unit. Includes all features needed for professional time management and logging.

- 1/100th precision STOPWATCH
- 10 hour timing capacity
- 50 lap memory
- Average, Fastest and Slowest laps display
- Count-up / count-down timer with repetition counter
- Pace alarm
- 12/24HR Time and Calendar displays, with alarm
- LCD "in-focus" display
- Ergonomic shell with neckstrap
- Water and Shock resistant

Order Code: **LCDSTP01**



## Helmet Money Box

Help them start saving for their first bike! Ceramic helmet moneybox with feature print design and Bike It logos. Every kid wants one.....

Order Code: **TOYMBX**



## Emergency 3 LED Dynamo Torch

LED wind-up torch is ideal for emergency use.

Compact design can be stored in bike or luggage.

Thumb-crank generates power – no batteries required.

3 ultra bright LEDs.

Wrist strap.

On/off switch.

Thumb-crank locks into torch body when not in use.

Order Code: **TORCH05**



## Air Horn

The race day necessity! Loud air horn. New hand pump type requires no gas

Order Code:  
**AIR001**



## Helmet Fun

The ultimate in lid decoration - easy-fit sucker novelties. We can't guarantee that the novelties will turn you into Britney or your other idols, but they will certainly turn heads!

Order Code	Description
<b>HFUPIG</b>	Pig tails (2pcs)
<b>HFUPONY</b>	Pony tail (1pc)



Bike It... do not condone speeding, but these little critters with their heavy duty suckers will surpass the UK national speed limits.

# HELMET FUN

Motocp  
Exhausts  
Screens  
Commuter  
Controls  
Headlights  
Indicators  
Mirrors  
Rear Lights  
Lifts & Stands  
Tools  
Batteries & Chargers  
Electrics  
Chain  
Servicing  
Tyres & Tubes  
Security  
Bike Accs  
Luggage  
Rider Accs  
Tank Pads  
Extras

www.bikeit.co.uk



# Keyfobs

Order Code Description

## APRILIA

KEYR55 RSV-MILLE 04>



KEYR55



KEYR84



KEYR50



KEYR93

## BUELL

KEYR84 XB12X



KEYR56



KEYR83



KEYR60



KEYR72

## DUCATI

KEYR50 999  
KEYR93 1098



KEYR69



KEYR51



KEYR88



KEYR38

## HONDA

KEYR60 CR250  
KEYR72 HORNET CB600F  
KEYR69 CBR600F 05>  
KEYR51 CBR600RR 2003-06  
KEYR88 CBR600RR 07>  
KEYR38 VFR750  
KEYR68 VFR800 ABS  
KEYR73 CBR900RR  
KEYR65 CBR1000RR >06  
KEYR89 CBR1000RR 07>  
KEYR70 VTR1000SP  
KEYR59 CBR1100XX BLACKBIRD  
KEYR71 GL1800 GOLDWING  
KEYR56 V-ROD  
KEYR83 FATBOY



KEYR68



KEYR73



KEYR65



KEYR89

## KAWASAKI

KEYR67 KX250  
KEYR54 ZX6-R 03-04  
KEYR76 ZX6R 05-06  
KEYR90 ZX6R 07>  
KEYR20 ZX9R  
KEYR94 Z1000 07>  
KEYR75 ZX10R >05  
KEYR95 ZX10R 06-07  
KEYR74 ZX12R  
KEYR96 ZZR-1400



KEYR70



KEYR59



KEYR71



KEYR67



KEYR54



KEYR76



KEYR90



KEYR20

## SUZUKI

KEYR58 RM250  
KEYR102 RMZ450  
KEYR105 LTR450  
KEYR52 GSXR600/750 >05  
KEYR97 GSXR600/750 06-07  
KEYR12 600 BANDIT  
KEYR57 SV650  
KEYR108 BANDIT 650 09>  
KEYR104 SFV650 GLADIUS  
KEYR103 GSX650F  
KEYR77 GSXR1000 05-08  
KEYR107 GSXR1000 09>



KEYR75



KEYR95



KEYR94



KEYR74



KEYR96



KEYR100



KEYR79



KEYR58

## YAMAHA

KEYR61 YZ250  
KEYR109 YFZ450R  
KEYR98 YZF-R 125  
KEYR80 FZ6 FAZER  
KEYR91 YZF-R6 06>  
KEYR81 FZS1000 FAZER  
KEYR04 VMAX  
KEYR82 XVS1000 DRAG STAR  
KEYR106 FZ-1 08>  
KEYR79 YZF-R1 05-06  
KEYR92 YZF-R1 07-08  
KEYR100 YZF-R1 09>  
KEYR99 VMAX 09>  
KEYR101 XJR1300



KEYR105



KEYR102



KEYR12



KEYR108



KEYR103



KEYR104



KEYR57



KEYR52



KEYR97



KEYR77



KEYR107



KEYR101

Colours and designs may vary

MotoGP  
Exhausts  
Screens  
Commuter  
Controls  
Headlights  
Indicators  
Mirrors  
Rear Lights  
Lifts & Stands  
Tools  
Batteries & Chargers  
Electrics  
Chain  
Servicing  
Tyres & Tubes  
Security  
Bike Accs  
Luggage  
Rider Accs  
Tank Pads  
Extras  
www.bikeit.co.uk





**See MotoGP  
section for official GP  
keyfobs**



## Sunglasses

Sports and leisure styled frames particularly suited for use by motorcyclists. All style feature robust frames and UV400 lenses. Supplied with drawstring storage bag.

Order Code	Description
GLA007	Chrome frame
GLA016	Black top frame only
GLA028	Black frame with cut out on arms
GLA325	2 tone frame - silver/black



Order Code	Description
GLAFUJI	Silver grey "Fuji" frame rose tint lens
GLABLK	Schwarzenegger black wraparound sun shades

All glasses supplied with protective drawstring storage pouch.

**UV400 LENSES**



MotoGP  
Exhausts  
Screens  
Commuter  
Controls  
Headlights  
Indicators  
Mirrors  
Rear Lights  
Lifts & Stands  
Tools  
Batteries & Chargers  
Electrics  
Chain  
Servicing  
Tyres & Tubes  
Security  
Bike Accs  
Luggage  
Rider Accs  
Tank Pads

**Extras**



## UTAG - In Case of Emergency

When you can't speak for yourself, UTAG can provide vital medical information and more....

Designed to be the first point of reference in an emergency

### Information stored includes:

- Emergency contact details
- Doctors contact details
- Blood type and key medical information
- Auto translation of key information in 7 languages
  - o English
  - o French
  - o German
  - o Dutch
  - o Spanish
  - o Italian
  - o Portuguese
- Private folder to store encrypted copies of important documents: Drivers licence, passport, travel documents, insurance etc.
- Water and dust resistant: IP57
- Print option



**Developed by ex-SAS soldiers for civilian use.**

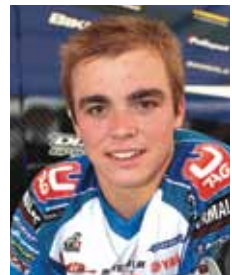

**RENAULT F1 Team**

**UTAG has already been adopted by the following personalities and institutions:**

### Renault Formula 1 Team.

"We spend our lives travelling to places where medical standards vary enormously and English is not always widely spoken. U Tag gives us reassurance that information about our medical needs and next of kin are readily available in a universally recognised format" – Pat Symonds, Executive Director of Engineering. UTAG is used by all of Renault's pit crews and executive personnel.

### Nicky Hayden & Chris Vermeulen – MotoGP Riders

**UTAG Yamaha World Moto-X Team** British and World MX1 & MX2 Championship

**British & World Superbike teams and riders**

**Suzi Perry – TV Presenter BBC Grandstand & Channel 5 Gadget Show**

**BMW Riders Club (UK)** Compulsory use at all club events.

**UK Constabularys** Police motorcycle officers and tactical cycle teams are wearing UTAG.

**Motorcycle Test Riders & Journalists** SUN, MCN, Bike, Ride, Motorcycle Racer, TWO, Fast Bikes, Superbike

**UTAG cycling team** Winners of the "Race Across America" ([www.raceacrossamerica.org](http://www.raceacrossamerica.org))

**UTAG is recommended by the British Safety Council**



## UTAG Sport

- Aluminum construction with mini USB chip
- Comes with nylon / Velcro wrist strap
- Can be worn around the neck as a mini Dogtag (chain not included);
- Secure 'Private Folder' to store scans / copies of important documents
- Compatible with Windows ME, 2000, XP and Vista
- Supports USB 1.1 / 2.0 standards
- 10 year data retention
- Size: 54mm x 30mm x 3.2mm
- Weight 6g
- UK IP tested IP57
- CE and FCC approved

Available in a choice of strap colours and sizes.

Order Code	Strap Colour	Strap Size
UTAGSPT08	Blue	Standard 26.5cm
UTAGSPT06	Blue	Small 22.8cm
UTAGSPT04	Pink	Standard 26.5cm
UTAGSPT02	Pink	Small 22.8cm
UTAGSPT10	Black	Standard 26.5cm
UTAGSPT14	Black	Small 22.8cm



MotoGP  
Exhausts  
Screens  
Commuter  
Controls  
Headlights  
Indicators  
Mirrors  
Rear Lights  
Lifts & Stands  
Tools  
Batteries & Chargers  
Electrics  
Chain  
Servicing  
Tyres & Tubes  
Security  
Bike Accs  
Luggage  
Rider Accs  
Tank Pads  
Extras  
[www.bikeit.co.uk](http://www.bikeit.co.uk)



## Dogtag

- Aluminium alloy construction with magnetic closure and 5mm chain hole
- Includes additional blank sided dogtag for personalisation and sound data
- Can be worn as dogtag, zip pull or on keyring
- Compatible with Windows ME, 2000, XP and Vista
- Supports USB 1.1 / 2.0 standards
- Utilises quality Samsung NAND chips
- 10 year data retention
- Size: 54mm x 30mm x 3.2mm
- Weight 10g
- UK IP tested IP57
- CE and FCC approved

In Gift Tin  
Order Code:  
**UTAGDOGTIN**



Blister Packed  
Order Code:  
**UTAGDOGMC**

Available in blister packaging or Gift Tin Pack.

## ICE Card

- Designed to be worn in an existing ID card holder, wallet or purse
- Compatible with Windows ME, 2000, XP and Vista
- Supports USB 1.1 / 2.0 standards
- Utilises quality Samsung NAND chips
- 10 year data retention
- Size: 54mm x 85mm x 3.2mm
- Weight 10g
- UK IP tested IP57
- CE and FCC approved

Blister Packed  
Order Code: **UTAGCRDBLI**



## UTAG POS & Starter Packs

A selection of UTAG starter packs is available.

Please call us for full details of the packs on offer.



## UTAG Vehicle Sticker

UTAG user vehicle sticker, applies to outside of vehicle. Size 16.5 x 29.5cm.

Order Code:  
**UTAGSTKA**



## Spare Tags

Personalise your UTAG with one of range of great pre-made spare tags.

Odercode	Description	Odercode	Description
UTAGSPR1	#1	UTAGSPRKW	KAWASAKI
UTAGSPR25	MX 250 F	UTAGSPRKX	KX
UTAGSPR45	MX 450 F	UTAGSPRMB	MX BABE
UTAGSPR46	#46	UTAGSPRMD	MX DIRT
UTAGSPR7	#7	UTAGSPRMR	MOTO X RIDER
UTAGSPRAP	APRILLA	UTAGSPRRM	RM
UTAGSPRCB	CBR	UTAGSPRSZ	SUZUKI
UTAGSPRCR	CR	UTAGSPRTR	TRIUMPH
UTAGSPRDU	DUCATI	UTAGSPRYA	YAMAHA
UTAGSPREM	EAT MY ROOST	UTAGSPRYZ	YZ
UTAGSPRGP	MOTOGP	UTAGSPRYZF	YZF
UTAGSPRGS	GSXR	UTAGSPRZX	ZXR
UTAGSPRHO	HONDA		



## Sports Pouch

Sport neoprene pouch specially designed to safely carry the UTAG dogtag during sport and activity. Available in Wrist pouch and Arm pouch versions.

Wrist Pouch  
Order Code: **UTAGACC03**

Arm Pouch  
Order Code: **UTAGACC06**



## Wrist Pouch

Sport wrist pouch specially designed to safely carry the UTAG dogtag during sport and activity.

Order Code:  
**UTAGACC01**



**U-TAG ICE**  
In Case of Emergency  
[www.utagice.com](http://www.utagice.com)

MotoGP  
Exhausts  
Screens  
Commuter  
Controls  
Headlights  
Indicators  
Mirrors  
Rear Lights  
Lifts & Stands  
Tools  
Batteries & Chargers  
Electrics  
Chain  
Servicing  
Tyres & Tubes  
Security  
Bike Accs  
Luggage  
Rider Accs  
Tank Pads  
Extras

[www.bikeit.co.uk](http://www.bikeit.co.uk)

## Sena SMH5 Motorcycle Bluetooth Communication System

New to the Sena range comes an entry-level Motorcycle Bluetooth Communication System, the SMH5. The SMH5 has been designed with the intent to provide a more pleasurable riding experience, in addition to a more cost effective product without sacrificing quality.

With features inherited from the SMH10, the SMH5 include Bluetooth v3 stereo, top rated stereo sound quality in its class, easy access and intuitive button operations using the revolutionary jog-dial control, Hands Free Profile for Bluetooth mobile phone, voice instructions for GPS navigation, and intercom range of up to 500 meters (545 yards) in open terrain.

The SMH5 is a Bluetooth v3+EDR Stereo Headset with Bluetooth Intercom designed specifically for motorcycles. With the SMH5, you can call hands-free on your Bluetooth mobile phone, listen to stereo music or voice instructions of GPS navigations by Bluetooth wirelessly, and have two-way intercom conversations in full duplex with a passenger or other motorcycle riders.

Thanks to the latest Bluetooth v3+EDR and the advanced digital processing technology, the SMH5 offers the best sound quality for both incoming and outgoing sound in its class. Also, the easy-to-access and intuitive button operations make the SMH5 a perfect companion for motorcycles.

### Features:

- Bluetooth Specification v3+EDR
- Bluetooth Intercom up to 500 meters (545 yards)\*
- Multi-Pair Two-way Bluetooth intercom
- Bluetooth stereo headset for Bluetooth audio devices such as MP3 players
- Bluetooth music playback control by AVRCP: play, pause, track forward and track back
- Easy operation by versatile Jog Dial (Patent Pending)
- Sufficient sound level with integrated audio booster
- Bluetooth hands-free for Bluetooth mobile phones
- Bluetooth headset or stereo headset for Bluetooth GPS navigations
- Water resistant for use in inclement weather
- Crystal clear and natural sound quality
- Up to 8 hours talk time, 7 days stand-by time
- Can be used while charging on road trips
- Individual volume control for each audio source
- Firmware Upgradeable

Order Code	Description
<b>SMH501</b>	Single Kit
<b>SMH5D01</b>	Dual Kit



\* in open terrain

### SMH5 Mounting Accessories Kit

SMH5 Helmet mounting Accessories Kit for use with Sena SMH5 Headset.

Order Code: **SMH5A0201**

**NEW**



### SMH5 Supplies Kit

SMH5 Supplies Kit for use with Sena SMH5 Headset. Includes replacement ear piece mounts, microphone cover, and various adhesive Velcro mounts.

Order Code: **SMH5A0202**

**NEW**

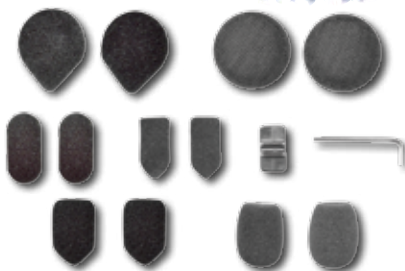

### SMH5 Helmet Clamp Full Kit - Attachable Boom

SMH5 Helmet Clamp Kit – Includes attachable Boom Microphone, clamp and speaker, for use with the Sena SMH5 Headset.

Order Code: **SMH5A0301**

**NEW**



### SMH5 Helmet Clamp Full Kit - Wired Micro-Phone

SMH5 Helmet Clamp Kit – includes wired microphone, clamp and speakers, for use with Sena SMH5 Headset.

Order Code: **SMH5A0302**

**NEW**



### SMH5 Attachable Boom Microphone Kit

SMH5 Attachable Boom Microphone Kit for use with Sena SMH5 Headset.

Order Code: **SMH5A0303**

**NEW**



### SMH5 Wired Microphone Kit

**NEW**

SMH5 Wired Microphone Kit for use with Sena SMH5 Headset.

Order Code: **SMH5A0304**



### SMH5 Large Speaker Kit

SMH5 Large speaker kit for use with Sena SMH5 Headset.

Order Code: **SMH5A0305**

**NEW**



Motorcycle  
Exhausts  
Screens  
Commuter  
Controls  
Headlights  
Indicators  
Mirrors  
Rear Lights  
Lifts & Stands  
Tools  
Batteries & Chargers  
Electrics  
Chain  
Servicing  
Tyres & Tubes  
Security  
Bike Accs  
Luggage  
Rider Accs  
Tank Pads  
Extras



## Sena SMH5FM Headset With Built-In FM Tuner

# SENA

The SMH5-FM is a Bluetooth 3.0 stereo headset with Bluetooth intercom and built-in FM tuner designed specifically for motorcycles. With the SMH5-FM, you can call handsfree on your Bluetooth mobile phone, listen to stereo music or voice instructions of GPS navigations by Bluetooth wirelessly, and have two-way intercom conversations in full duplex with a passenger or other motorcycle riders.

Thanks to the latest Bluetooth 3.0 and the advanced digital signal processing technology, the SMH5 offers the best sound quality for both incoming and outgoing sound in its class. Also, the easy-to-access and intuitive button operations make the SMH5-FM a perfect companion for motorcycles.

### Features

- Bluetooth 3.0
- Bluetooth intercom up to 700 meters (760 yards)\*
- Built-in FM radio tuner with station scan and save function
- Multi-pair Bluetooth intercom
- Voice prompts
- Bluetooth stereo headset by A2DP
- Bluetooth music playback control by AVRCP: Play, pause, track forward and track back
- Easy operation by versatile Jog Dial
- Sufficient sound level with integrated audio booster
- Bluetooth handsfree for Bluetooth mobile phones
- Bluetooth headset or stereo headset for Bluetooth GPS navigations
- Water resistant for use in inclement weather
- Crystal clear and natural sound quality
- Up to 7 hours talk time, 6 days stand-by time
- Can be used while charging on road trips
- Individual volume control for each audio source
- Firmware upgradeable
- Peace of mind - thanks to the two-year warranty

\* in open terrain

Order Code: **SMH5FM01**

**NEW**



## Sena SR10 Bluetooth 2-Way Radio Adapter

# SENA

Allows multiple devices to be wirelessly connected to a Sena headset. Allows connection to 2-Way radios offering greater range.

The SR10 is a Class 1 Bluetooth Two-way Radio adapter based on Bluetooth 2.1+EDR technology. You can connect various two-way radio devices in the market by using SR10 and may talk wirelessly using Bluetooth headsets in the market. SR10 has two AUX ports that enable you to connect non-Bluetooth devices such as radar detector or GPS navigation.

Along with SR10, you can talk by phone or by two-way radios at the same time, listen to alarm signal from radar detector and listen to the guides from GPS Navigation. The SR10 may cover such a various application areas as motorcycle group riding, outdoor sports and activities or security.

### Features:

- Bluetooth hands-free adapter for two-way radios
- Bluetooth hands-free gateway for mobile phones
- Connect 1 two-way radio and 1 mobile phone simultaneously
- Compatible with standard stereo or mono Bluetooth headsets
- AUX input for GPS, radar or laser detectors
- Handlebar mounting & belt clamping
- Wired PTT button extension for handlebar grip mounting
- Optional 12V bike-powered kit with on/off control by ignition switch
- Firmware upgradeable

Order Code: **SR1003**

## Sena SR10 Accessories

Order Code	Description
SCA0103	Sena Cigarette Charger (Micro-Usb Type)
SCA0105	Sena Phone Cable 3.5Mm 4-Pole (Iphone/Blackberry/Samsung/Htc)
SCA0106	Sena Phone Cable 3.5Mm 4-Pole (Nokia)
SCA0110	Sena 2-Way Radio Cable For Kenwood Twin-Pin
SCA0111	Sena 2-Way Radio Cable For Motorola Twin-Pin
SCA0112	Sena 2-Way Radio Cable For Motorola Single-Pin
SCA0113	Sena 2-Way Radio Cable For Icom Twin-Pin
SCA0114	Sena 2-Way Radio Cable For Yaesu Single-Pin
SCA0115	Sena 2-Way Radio Cable For Midland Twin-Pin
SR10A0202	Sena Leads for SR10



Motorcycle  
Exhausts  
Screens  
Commuter  
Controls  
Headlights  
Indicators  
Mirrors  
Rear Lights  
Lifts & Stands  
Tools  
Batteries & Chargers  
Electrics  
Chain  
Servicing  
Tyres & Tubes  
Security  
Bike Accs  
Luggage  
Rider Accs  
Tank Pads  
Extras

**SMH10**  
Motorcycle  
Bluetooth® Headset & Intercom



The SMH10 is a Bluetooth v3 Class 1 Stereo Headset with long-range Bluetooth Intercom designed specifically for motorcyclists. With the SMH10, you can call hands-free on your Bluetooth mobile phone, listen to stereo music or voice instructions of GPS navigations by Bluetooth wirelessly, and have intercom conversations in full duplex with a passenger or other motorcycle riders.

Thanks to the latest Bluetooth v3 and the advanced digital processing technology, the SMH10 offers the best sound quality for both incoming and outgoing sound in its class. Also, the easy-to-access and intuitive button operations make the SMH10 a perfect companion for motorcyclists.

Features:

- Bluetooth Specification v3
- Bluetooth Intercom up to 900 meters (980 yards)\*
- Multi-Pair Bluetooth intercom for 4 persons
- Bluetooth stereo headset for Bluetooth audio devices such as MP3 players
- Bluetooth music playback control by AVRCP: play, pause, track forward and track back
- Easy operation by versatile Jog Dial
- Sufficient sound level with integrated audio booster
- Bluetooth hands-free for Bluetooth mobile phones
- Bluetooth headset or stereo headset for Bluetooth GPS navigations
- Stereo music by 3.5mm audio cable
- Water resistant for use in inclement weather
- Crystal clear and natural sound quality
- Up to 12 hours talk time, 10 days stand-by time
- Can be used while charging on road trips
- Individual volume control for each audio source



\* in open terrain



**Easy-use Jog Dial**  
- even with gloved hands  
  
Play/pause music  
Start/end intercom



Adjust volume



Track forward/back

MotoGP  
Exhausts  
Screens  
Commuter  
Controls  
Headlights  
Indicators  
Mirrors  
Rear Lights  
Lifts & Stands  
Tools  
Batteries & Chargers  
Electrics  
Chain  
Servicing  
Tyres & Tubes  
Security  
Bike Accs  
Luggage  
Rider Accs  
Tank Pads  
Extras



## SMH10 Bluetooth Headset & Intercom - Single

Single unit SMH10 Bluetooth Headset & Intercom.

Includes;

- Base clamp-unit attaches to the shell of all motorcycle helmet types
- Integral boom-mic and ear-piece speakers
- Detachable Bluetooth unit
- 3.5mm jack audio cable for MP3 attachment
- Power charger (USB / UK 3-pin)

**SENA**  
**SMH10**

Order Code:  
**SMH1010**



## SMH10 Bluetooth Headset & Intercom - Dual

Dual pack of two SMH10 Bluetooth Headsets & Intercoms

Includes;

- Base clamp-unit attaches to the shell of all motorcycle helmet types
- Integral boom-mic and ear-piece speakers
- Detachable Bluetooth unit
- 3.5mm jack audio cable for MP3 attachment
- Power charger (USB / UK 3-pin)

**SENA**  
**SMH10**

Order Code:  
**SMH10D10**



## SMH10 Clamp Unit

Replacement clamp unit featuring boom-mic and ear-piece speakers.

Allows use of the detachable SMH10 Bluetooth unit on other helmet without needing to remove the original clamp unit.

Order Code: **SMHA0301**



## SMH10 Wired Microphone Clamp Unit

This replacement clamp unit features the same ear-piece speakers as supplied in the SMH10 kit, but with different wired microphone options. These microphone options offer alternative internal fitting options, suitable for flip-front and full face helmets.

Order Code: **SMHA0302**



## SENA Helmet Clamp Kit for Earbuds

Alternative version of the helmet clamp kit for use with the SENA SMH10 Bluetooth unit. Features; - removable microphone (boom type and wired type both supplied) - attachment for fitment of earbuds / earphones. Allows use of earbuds.

Order Code: **SMHA0304**



## SENA Helmet Clamp Kit for Earbuds (Fixed Mic)

Alternative version of the helmet clamp kit for use with the SENA SMH10 Bluetooth unit.

Features;

Fixed boom microphone attachment for fitment of earbuds / earphones

Allows user to install their own ear-buds instead of in-helmet speakers

Order Code: **SMHA0303**



## SMH10 Cigarette Socket Power Lead

Power lead for SMH10 Bluetooth Unit. Provides power from an in-car or on-bike cigarette lighter socket

Order Code: **SMHA0107**



NB: This is not a phone charger

## SMH10 Audio Cable

Replacement audio cable for SMH10 Bluetooth  
3.5mm jack for MP3 / audio device attachment

Order Code: **SMHA0108**



Motorcycle  
Exhausts  
Screens  
Commuter  
Controls  
Headlights  
Indicators  
Mirrors  
Rear Lights  
Lifts & Stands  
Tools  
Batteries & Chargers  
Electrics  
Chain  
Servicing  
Tyres & Tubes  
Security  
Bike Accs  
Luggage  
Rider Accs  
Tank Pads

Extras



The SPH10 is a Bluetooth v3+EDR Class 1 Stereo Headset with long-range Bluetooth Intercom designed specifically for outdoor sports and activities. With the SPH10, you can call hands-free on your Bluetooth mobile phone, listen to stereo music or voice instructions of GPS navigations by Bluetooth wirelessly, and have intercom conversations in full duplex with your companions.

Thanks to the latest Bluetooth v3+EDR and the advanced digital processing technology, the SPH10 offers the best sound quality in its class. The easy-to-access and intuitive button operations make the SPH10 a perfect companion for outdoor sports.

Features:

- Bluetooth v3+EDR
- Firmware upgradeable
- Bluetooth intercom up to 900 meters (980 yards)\*
- Multi-Pair Bluetooth intercom for 4 persons
- Bluetooth stereo headset
- Bluetooth music playback control by AVRCP (Audio Video Remote Control Profile): play, pause, track forward and track back
- Easy headset Controls by versatile Jog Dial
- Sufficient sound level with integrated audio booster
- Bluetooth hands-free for Bluetooth mobile phones
- Bluetooth headset for GPS navigations
- Durable, sweat and water resistant
- 10 hours talk time, 7 days stand-by time

\* in open terrain

Order Code: SPH1003



MotoGP  
Exhausts  
Screens  
Commuter  
Controls  
Headlights  
Indicators  
Mirrors  
Rear Lights  
Lifts & Stands  
Tools  
Batteries & Chargers  
Electrics  
Chain  
Servicing  
Tyres & Tubes  
Security  
Bike Accs  
Luggage  
Rider Accs  
Tank Pads  
Extras  
www.bikekit.co.uk



NEW



The SMH10R is a Bluetooth 3.0 stereo headset with long-range Bluetooth intercom designed specifically for motorcycle riders who prefer smaller form factor for maximizing their riding performance, yet maintaining rich features of Bluetooth intercom. With the SMH10R, you can call handsfree on your Bluetooth mobile phone, listen to stereo music or voice instructions of GPS navigations by Bluetooth wirelessly, and have intercom conversations in full duplex with other riders.

Thanks to the latest Bluetooth and the advanced digital signal processing technology inherited from the SMH10, the SMH10R offers the best sound quality for both incoming and outgoing sound in its class. Also, its super thin and compact form factor contribute higher performance for sports bike riding and it makes the SMH10R a perfect companion of motorcycle riders.

Features

- Bluetooth 3.0
- Bluetooth intercom up to 900 meters (980 yards)\*
- Light weight and ultra slim profile
- Four-way conference intercom
- Conference phone call with intercom participant
- Multipoint for mobile phone+GPS
- Voice prompts
- Bluetooth stereo headset for Bluetooth audio devices such as MP3 players
- Bluetooth music playback control by AVRCP: Play, pause, track forward and track back
- Sufficient sound level with integrated audio booster
- Bluetooth handsfree for Bluetooth mobile phones
- Bluetooth headset or stereo headset for Bluetooth GPS navigations
- Water resistant for use in inclement weather
- Crystal clear and natural sound quality
- Can be used while charging on road trip
- Individual volume control for each audio source
- Firmware upgradeable
- Peace of mind - thanks to the two-year warranty

\* in open terrain

Order Code: **SMH10R**

Sena SMH10R Accessories

Order Code Description  
**SMH10RA0201** Sena Supply Kit

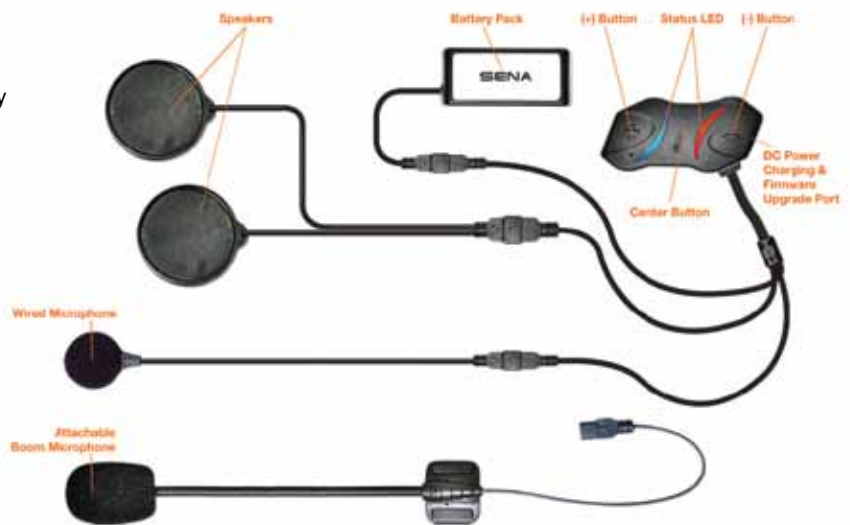

Motorcycle  
 Exhausts  
 Screens  
 Computer  
 Controls  
 Headlights  
 Indicators  
 Mirrors  
 Rear Lights  
 Lifts & Stands  
 Tools  
 Batteries & Chargers  
 Electrics  
 Chain  
 Servicing  
 Tyres & Tubes  
 Security  
 Bike Accs  
 Luggage  
 Rider Accs  
 Tank Pads  
 Extras

### Sena DC Power Charger/USB Power Cable (EURO Plug)

**NEW**

DC Power Charger and Micro USB Power & Data Cable EURO 2 pin plug kit for use with Sena products used in europe. 2 pin plug.

Order Code: **SMHB0102**



### Sena DC Power Charger/USB Power Cable (Uk Plug)

**NEW**

DC Power Charger and Micro USB Power & Data Cable UK 3 pin plug kit for use with Sena products used in the UK. 3 pin plug.

Order Code: **SMHB0103**



### Sena Cigarette Socket Charger With Micro USB Head

**NEW**

Cigarette Charger (Micro USB Type) for use with all Sena products that have a Micro USB socket.

Order Code: **SMHB0107**



### Sena USB Wall Charger

**NEW**

World wide USB wall charger for use with all Sena products that use a micro USB connection.

Order Code: **SMHB0108**



### Sena USB Power & Data Cable

**NEW**

USB power and data cable for use with all Sena products that use a micro USB connection.

Order Code: **SMHB0106**





## BikeTek Lap Timer

- > Laptimer with wireless I.R transmitter
- > A simple and reliable lap-timing unit for all race and practice purposes
- > Compact and lightweight design, the LCD-display receiver is easily mounted to road and off-road motorcycles, karts, cars and cycles
- > Pitwall transmitter unit, powered by two AA batteries (not included)
- > 15 metre range (transmitter<->receiver)
- > Memory capacity of 64 laps / 99 minutes
- > 65x40x11mm receiver unit with wired IR-eye
- > Viewable data; individual lap timings : slowest lap : fastest lap : total time : average lap time
- > 40x20mm LCD display
- > 940nm frequency

Order Code: *TIM011*



# BIKETEK

The receiver should be mounted to the vehicle in an appropriate position which does not interfere with vehicle functioning (self-adhesive velcro mount included).

When the receiver (fitted to the vehicle) passes by the I.R transmitter (left in a suitable location such as pitwall) the lap number is displayed and time is recorded, building up data of lap splits.

If multiple Biketek laptimers are in use in the same session, just one transmitter should be used (ensure no more than one transmitter is in use).

It is the user's responsibility to ensure that laptiming devices are authorised for use at the track / circuit.

## 12V Accessory Power Supply Socket Kits

12V power supply kit for motorcycle fitment.

Enables use of electrical product from cigarette lighter socket or USB socket, such as mobile phone charger, Sat-Nav etc \*.

Can be installed under seat or handlebar mounted.

Quick-connector allows unit to be disconnected from battery and removed when not in use.

\* does not include any charger leads

Order Code	Description
<b>POWSUP11</b>	Cigarette lighter socket
<b>POWSUP12</b>	USB socket



POWSUP11



POWSUP12

**NEW**

Motorcycle  
Exhausts  
Screens  
Commuter  
Controls  
Headlights  
Indicators  
Mirrors  
Rear Lights  
Lifts & Stands  
Tools  
Batteries & Chargers  
Electrics  
Chain  
Servicing  
Tyres & Tubes  
Security  
Bike Accs  
Luggage  
Rider Accs  
Tank Pads

Extras



**Bike** *it* **.co.uk**

# OFF ROAD

**ISSUE 13**

[WWW.BIKEIT.CO.UK](http://WWW.BIKEIT.CO.UK)

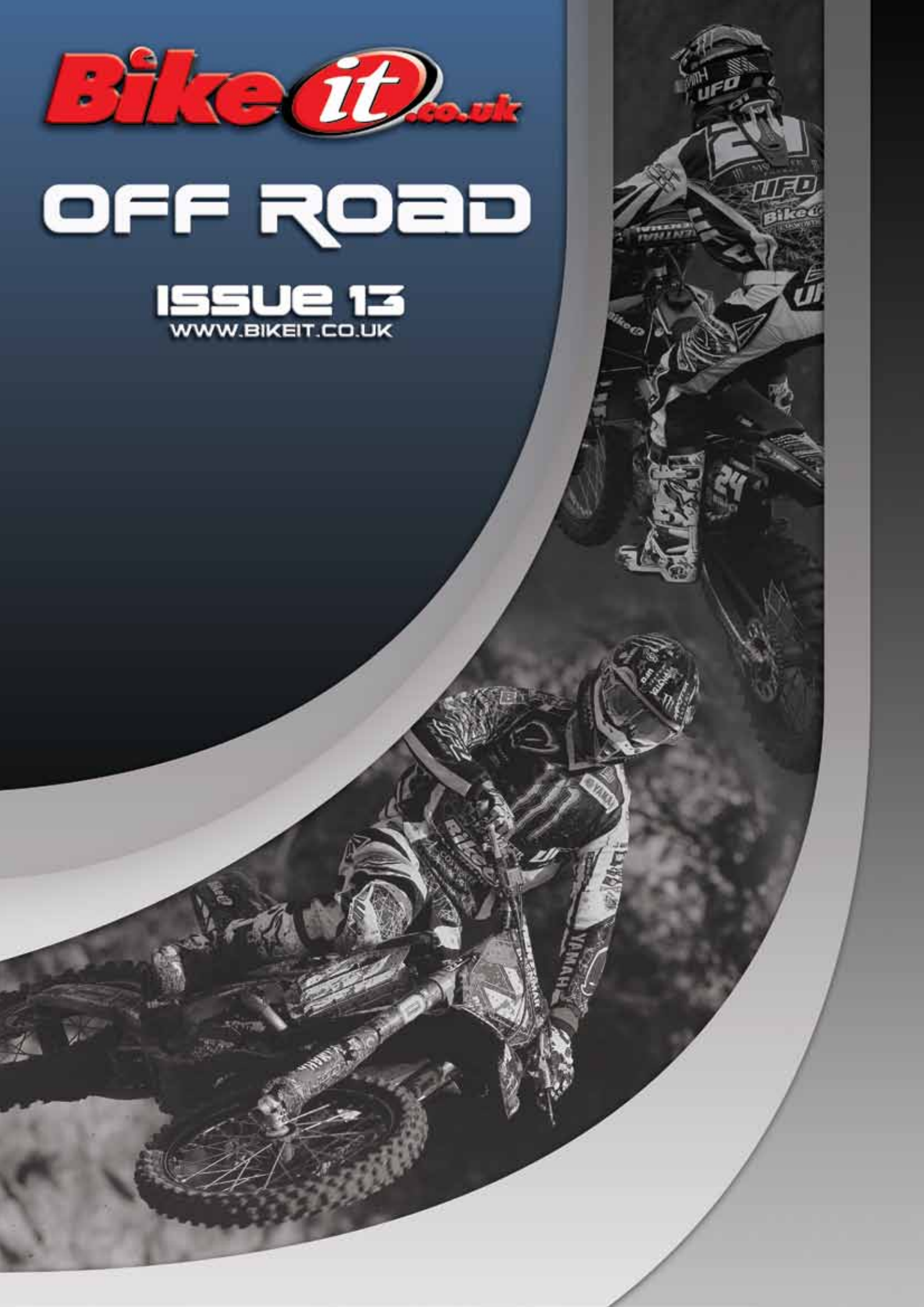



After a successful 2012 season, which saw the **Bike It** sponsored Factory Monster Energy Yamaha team enjoy podium success in the American AMA Supercross series, World Championship, British Championship and European Championship, with Mel Pocock winning the European EMX2 title.

2013 will continue to see the **Bike It** sponsored Factory Monster Energy Yamaha team field another strong International team with Dean Ferris from Australia, Mel Pocock from the UK and Maxime Desprey from France, all competing in the highly competitive MX2 class. In the European EMX2 championship the team will field British rider Ryan Houghton and Norwegian rider Magne Klingsheim.

At this level, you can't rest on your laurels so the team will continue to work with the **Bike It** R and D department to continually improve the **Bike It** range of products used at GP level, ensuring the end user product that has been developed and tested at the highest level.

Using the Triple S chain, Filtrex Filters, Armstrong oversized discs, pads and hangers at Grand Prix level can only be a true testament on the **Bike It** brand quality.

In the paddock and the workshop the team will continue to work with the Biketek workshop tools and consumables that make life easy as a mechanic or an occasional user. From lock wire to fuel cans and bike lifts the mechanics can rely on the Biketek ever expanding range to get the job done.



rayacher image

***Bike It... Making champions. Again.***

## Forged Foot Pegs

Premium forged aluminium off road footpegs.  
Wide platform design for increased control.  
Features replaceable screw-studs for optimum boot contact.  
Available in variety of colours.

Model	Year	Order Code	Colour
-------	------	------------	--------

### Honda

CR125	02-12	FOX11	BLK / GM / R
CRF150	07-12	FOX11	BLK / GM / R
CR250	02-12	FOX11	BLK / GM / R
CRF250	02-12	FOX11	BLK / GM / R
CR450	02-12	FOX11	BLK / GM / R
CRF450	02-12	FOX11	BLK / GM / R

### Kawasaki

KX125	03-08	FOX99	BLK / GM / GN
KX250 F	04	FOX99	BLK / GM / GN
KX250 F	05-08	FOX66	BLK / GM / GN
KX250 F	06-12	FOX22	BLK / GM / GN
KX450 F	07-12	FOX22	BLK / GM / GN

### KTM

All models	98-12	FOX88	BLK / GM / OR
------------	-------	-------	---------------

### Gas Gas

All models	97>	FOX77	BLK / GM / BU
------------	-----	-------	---------------

### Suzuki

RM-Z250	04	FOX99	BLK / GM
RM-Z250	07-09	FOX33	BLK / GM / GD
RM-Z250	10-12	FOX55	BLK / GM / GD
RM-Z450	05-07	FOX33	BLK / GM / GD
RM-Z450	08-09	FOX44	BLK / GM / GD
RM-Z450	10-12	FOX55	BLK / GM / GD

### Yamaha

YZ85	99-12	FOX77	BLK / GM / BU
YZ125	99-12	FOX77	BLK / GM / BU
WR250F	99-12	FOX77	BLK / GM / BU
YZ250	99-12	FOX77	BLK / GM / BU
YZ250F	99-12	FOX77	BLK / GM / BU
WR400F	98-99	FOX77	BLK / GM / BU
YZ400F	98-99	FOX77	BLK / GM / BU
WR426F	00-03	FOX77	BLK / GM / BU
YZ426F	00-03	FOX77	BLK / GM / BU
WR450F	01-12	FOX77	BLK / GM / BU
YZ450F	01-12	FOX77	BLK / GM / BU



ADD SUFFIX FOR COLOUR		Ordercode	Description
		<b>FOXSTUD</b>	Replacement screw-stud pack (18pcs)
GM	Gun Metal		
R	Red		
BU	Blue		
GN	Green		
GD	Gold		
BLK	Black		
OR	Orange		

## Footpeg Gaitors

These silicone covers fit over footpeg mounts, stopping mud and dirt clogging up springs and hinges. Protects footpegs and improves operation.

Order Code: **FOXRUB13**

**NEW**





## Steering Stem Nuts

Replacement upgrade steering stem nuts for off-road bikes. Switch out the standard steering stem nut for a premium CNC machined coloured alternative. Weight-saving design and construction, precision CNC machined aluminium alloy. Available in black and gold anodised options.



Model	Year	Size (thread diam x tool diam x pitch x height)	Black Order Code	Gold Order Code
<b>Honda</b>				
CR85 R	03-07	M25 x 30 x P1.0 x H12	<i>STRSTM09</i>	<i>STRSTM12</i>
CR125 R	01-07	M26 x 32 x P1.0 x H10	<i>STRSTM15</i>	<i>STRSTM18</i>
CRF150 R	07-12	M25 x 30 x P1.0 x H12	<i>STRSTM09</i>	<i>STRSTM12</i>
CR250 R	01-07	M26 x 32 x P1.0 x H10	<i>STRSTM15</i>	<i>STRSTM18</i>
CRF250 X	04-11	M26 x 32 x P1.0 x H10	<i>STRSTM15</i>	<i>STRSTM18</i>
CRF250 R	04-12	M26 x 32 x P1.0 x H10	<i>STRSTM15</i>	<i>STRSTM18</i>
CRF450 R	02-12	M26 x 32 x P1.0 x H10	<i>STRSTM15</i>	<i>STRSTM18</i>
CRF450 X	05-09	M26 x 32 x P1.0 x H10	<i>STRSTM15</i>	<i>STRSTM18</i>
<b>Kawasaki</b>				
KX65	00-12	M22 x 30 x P1.0 x H12	<i>STRSTM03</i>	<i>STRSTM06</i>
KX85	01-12	M22 x 30 x P1.0 x H12	<i>STRSTM03</i>	<i>STRSTM06</i>
KLX125	10-11	M22 x 30 x P1.0 x H12	<i>STRSTM03</i>	<i>STRSTM06</i>
KX125	88-91	M22 x 30 x P1.0 x H12	<i>STRSTM03</i>	<i>STRSTM06</i>
KX125	04-08	M24 x 32 x P1.5 x H10	<i>STRSTM27</i>	<i>STRSTM30</i>
KLX250	98-12	M22 x 30 x P1.0 x H12	<i>STRSTM03</i>	<i>STRSTM06</i>
KX250	88-91	M22 x 30 x P1.0 x H12	<i>STRSTM03</i>	<i>STRSTM06</i>
KX250	04-08	M24 x 32 x P1.5 x H10	<i>STRSTM27</i>	<i>STRSTM30</i>
KX250 F	04-12	M24 x 32 x P1.5 x H10	<i>STRSTM27</i>	<i>STRSTM30</i>
KLX450R	08-09	M24 x 32 x P1.5 x H10	<i>STRSTM27</i>	<i>STRSTM30</i>
KX450 F	06-12	M24 x 32 x P1.5 x H10	<i>STRSTM27</i>	<i>STRSTM30</i>
<b>Suzuki</b>				
RM65	00-12	M22 x 30 x P1.0 x H12	<i>STRSTM03</i>	<i>STRSTM06</i>
RM85	02-12	M22 x 30 x P1.0 x H12	<i>STRSTM03</i>	<i>STRSTM06</i>
RM125	04>	M24 x 32 x P1.0 x H12	<i>STRSTM21</i>	<i>STRSTM24</i>
RM250	04>	M24 x 32 x P1.0 x H12	<i>STRSTM21</i>	<i>STRSTM24</i>
RMX250 / S	92-98	M24 x 32 x P1.5 x H10	<i>STRSTM27</i>	<i>STRSTM30</i>
RM-Z250	04-06	M24 x 32 x P1.5 x H10	<i>STRSTM27</i>	<i>STRSTM30</i>
RM-Z250	07-11	M24 x 32 x P1.0 x H12	<i>STRSTM21</i>	<i>STRSTM24</i>
RM-Z450	05-11	M24 x 32 x P1.0 x H12	<i>STRSTM21</i>	<i>STRSTM24</i>
RMX450Z	10>	M24 x 32 x P1.0 x H12	<i>STRSTM21</i>	<i>STRSTM24</i>
<b>Yamaha</b>				
YZ125	94-12	M24 x 32 x P1.0 x H12	<i>STRSTM21</i>	<i>STRSTM24</i>
WR250 F	01-09	M24 x 32 x P1.0 x H12	<i>STRSTM21</i>	<i>STRSTM24</i>
YZ250	94-12	M24 x 32 x P1.0 x H12	<i>STRSTM21</i>	<i>STRSTM24</i>
YZ250 F	01-12	M24 x 32 x P1.0 x H12	<i>STRSTM21</i>	<i>STRSTM24</i>
YZ400/426 F	98-02	M24 x 32 x P1.0 x H12	<i>STRSTM21</i>	<i>STRSTM24</i>
WR450 F	04-09	M24 x 32 x P1.0 x H12	<i>STRSTM21</i>	<i>STRSTM24</i>
YZ450 F	03-12	M24 x 32 x P1.0 x H12	<i>STRSTM21</i>	<i>STRSTM24</i>

## Forged Gear Pedals

Premium upgrade replacement gear pedals.  
 Forged aluminium body.  
 Folding serrated toe platform for extra boot contact.  
 Available in variety of coloured tips.

Model	Year	Order Code	Colour
-------	------	------------	--------

### Honda

CR80 / 85	96-07	GPDH02	BLK / R
CR125	83-07	GPDH04	BLK / R
CR250	84-87	GPDH06	BLK / R
CR250	90-03	GPDH06	BLK / R
CR250	04-07	GPDH08	BLK / R
CRF250R/X	04-09	GPDH10	BLK / R
CRF250R	10>	GPDH12	BLK / R
CRF450R	06-07	GPDH06	BLK / R
CRF450R	08-10	GPDH14	BLK / R
CRF450X	05-09	GPDH16	BLK / R
CR500	84-88	GPDH06	BLK / R

### Kawasaki

KX65	00-12	GPDK03	BLK / GN
KX80 / 85	91-12	GPDK06	BLK / GN
KX100	95-12	GPDK06	BLK / GN
KX125	94-05	GPDK09	BLK / GN
KX250	94-02	GPDK09	BLK / GN
KX250	05-07	GPDK09	BLK / GN
KX250 F	06-07	GPDK12	BLK / GN
KX250 F	09-12	GPDK15	BLK / GN
KX450 F	06-08	GPDK18	BLK / GN
KX450 F	09-11	GPDK21	BLK / GN

### KTM

SX65	98-08	GPDM02	BLK / OR
SX65	09-12	GPDM04	BLK / OR
SX85	03-12	GPDM06	BLK / OR
SX125	98-00	GPDM10	BLK / OR
SX125	01-12	GPDM08	BLK / OR
SX150/XC	09-12	GPDM08	BLK / OR
250SX-F	11>	GPDM08	BLK / OR
250XC / XC-F	06-12	GPDM10	BLK / OR
250XCF-W	06-08	GPDM10	BLK / OR
250XCF-W	09-10	GPDM08	BLK / OR
250XCF-W	11-12	GPDM12	BLK / OR
250SX-F / XC-F	11-12	GPDM12	BLK / OR
SX250	94-12	GPDM10	BLK / OR
350SX-F / XC-F	12>	GPDM08	BLK / OR
450MXC	03-05	GPDM12	BLK / OR
SX450	03-06	GPDM12	BLK / OR
450SX-F	12>	GPDM08	BLK / OR
SX525	03-05	GPDM12	BLK / OR
525MXC	03-04	GPDM12	BLK / OR

### Suzuki

RM65	00-12	GPDK03	BLK
RM80	89-04	GPDS03	BLK / GD
RM85	02-09	GPDS03	BLK / GD
RM125	83-07	GPDS06	BLK / GD
RM250	89-93	GPDS06	BLK / GD
RM250	94-08	GPDS09	BLK / GD
RM-Z250	04-06	GPDS12	BLK / GD
RM-Z250	08-09	GPDS15	BLK / GD
RM-Z450	05-07	GPDS18	BLK / GD
RM-Z450	08-10	GPDS21	BLK / GD

### Yamaha

YZ80 / YZ85	90-10	GPDY03	BLK / BU
YZ125	96-04	GPDY06	BLK / BU
YZ125	05-11	GPDY09	BLK / BU
WR250	89-98	GPDY06	BLK / BU
WR250F / 450F	07-11	GPDY18	BLK / BU
YZ250	89-04	GPDY06	BLK / BU
YZ250	05-11	GPDY09	BLK / BU
YZ250F	02-05	GPDY12	BLK / BU
YZ250F	06-11	GPDY18	BLK / BU
WR400F / 426F	98-02	GPDY12	BLK / BU
WR450F	03-06	GPDY12	BLK / BU
YZ400F / 426F	98-02	GPDY12	BLK / BU
YZ450F	03-05	GPDY12	BLK / BU
YZ450F	06-10	GPDY15	BLK / BU



## Forged Brake Pedals

Premium upgrade replacement brake pedals.  
 Forged aluminium body.  
 Feature toothed toe platform for extra boot contact.

Model	Year	Order Code
-------	------	------------

### Honda

CRF250	10-12	BPDH03
CRF450	05-12	BPDH06

### Kawasaki

KX250 F	06-12	BPKD02
KX450 F	06-12	BPKD04

### KTM

125-525	07-11	BPDM02
---------	-------	--------

### Suzuki

RM-Z250	07-12	BPDS03
RM-Z450	08-12	BPDS06

### Yamaha

YZ250F	10-12	BPDY02
YZ450F	10-12	BPDY04





### Off-Road Mud Remover

A robust plastic tool to remove mud and dirt from bikes. 38cm length with varied width contoured ends. Smoothed edges to eliminate scratching.

Order Code: **MUDBK**



### Side Kickstands

Universal sprung-loaded off-road side kickstands, fit most off-road motorcycles. Simply bolt to swinging arm.

Order Code	Description
<b>KCKU10</b>	325mm length
<b>KCKU12</b>	395mm length

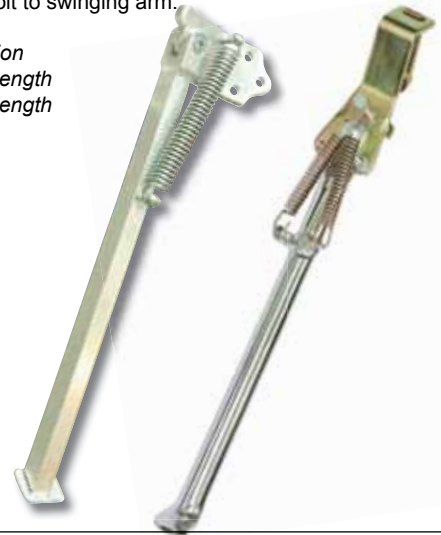

### Clutch Cable Covers

Durable silicone sleeves fit around exposed clutch cable, prevents water, dirt and debris damaging cable. Available in five OEM colours.

Order Code	Colour
<b>CLTCBL01</b>	Blue
<b>CLTCBL03</b>	Green
<b>CLTCBL05</b>	Orange
<b>CLTCBL07</b>	Red
<b>CLTCBL09</b>	Yellow

**NEW**

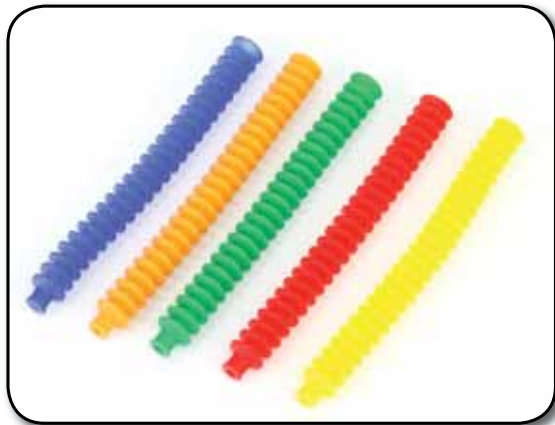

### Fork Air Bleeders

Allows bleeding of air pressure in MX forks without additional tools. Easy to install. Simply replaces the OEM bleeder screw

Order Code	Description
<b>FKB31</b>	Fits most KAYABA and SHOWA upside-down forks with M5x0.8 OE screws.
<b>FKB33</b>	Fits KTM/WP 43-48mm with M4x0.7 OE screws.



### Hour Meters

Hour meters record the actual running time of an engine to encourage correct servicing at regular intervals. The meter is accumulative and data is non-erasable.

- Works on any petrol engine, 2 or 4 stroke
- Low power consumption
- Easy installation
- Waterproof to IP68 standard
- Records and displays up to 99999 RPM (hour/tachometer) and 9999.9 hours (hour meter and hour/tachometer)
- Up to 2 year battery life, 17500 hours of standby time

**NEW**

Order Code	Description
<b>MTR002</b>	Hour Meter
<b>MTR004</b>	Hour/Tacho

MTR004

MTR002



### Neoprene Fork Gaiters

Neoprene sleeves fit around off-road front forks. The sleeves prevent water, dirt and debris damaging the fork stanchions and entering fork dust seals. Supplied with cable ties for fitting. 5x36.5cm. Sold as pair.

Order Code: **FRKGTR10**

**NEW**



## Aluminium Loading Ramps

**NEW**

Strong and durable loading ramps, made from lightweight aluminium, enable safe and easy loading and unloading of motorcycles and scooters. Space-saving folding design, allows compact storage when not in use. Features coated extension arms on top end for stability during use. Rigid aluminium box section side rails. Strong aluminium centre plates with cut-outs for tyre grip. Available in three width options. Max load 340kgs/ramp.

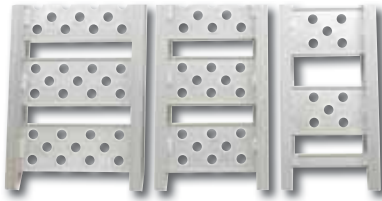

Order Code	Type	Width	Length
<b>PDSRAMP06</b>	Bi-folding	200mm	2150mm
<b>PDSRAMP07</b>	Tri-folding	230mm	1935mm
<b>PDSRAMP08</b>	Tri-folding	280mm	1935mm



## Loading Ramp

Constructed from ultra lightweight aluminium, and utilising a unique folding design, Loading Ramps are perfect for loading motorcycles on / off trailers and transport vehicles.

Each ramp is 2170mm length when extended, available in two widths. Max load: 340 Kgs / 750 Lbs

Order Code	Size
<b>PDSRAMP01</b>	230mm width
<b>PDSRAMP04</b>	280mm width



## Loading Ramp Bag

Padded storage bag for loading ramp. Zip closing with carry handles.

Order Code	Description
<b>PDSRAMP03</b>	Fits PDSRAMP01
<b>PDSRAMP05</b>	Fits PDSRAMP04



NB. Ramp not included

## ATV Loading Ramp

Constructed from ultra lightweight aluminium, and utilising a unique folding design, this Loading Ramp is perfect for loading ATV's and quads, when using two ramps, on / off trailers.

Simply order 2 ramps and one adaptor kit. Each kit contains 2 adjustable arms that clip onto the inner struts of each ramp, stabilising and keeping them parallel. Each arm can be adjusted to change the width between ramps from 520mm to 940mm.

EXTENDED PLATE LENGTH = 2170mm  
Max load: 340 Kgs / 750 Lbs per ramp

Order Code	Description
<b>PDSRAMP02</b>	ATV adaptor kit
<b>PDSRAMP01*</b>	Loading ramp, 230mm width
<b>PDSRAMP04*</b>	Loading ramp, 280mm width

\* Order 2 loading ramps for ATV / quad use

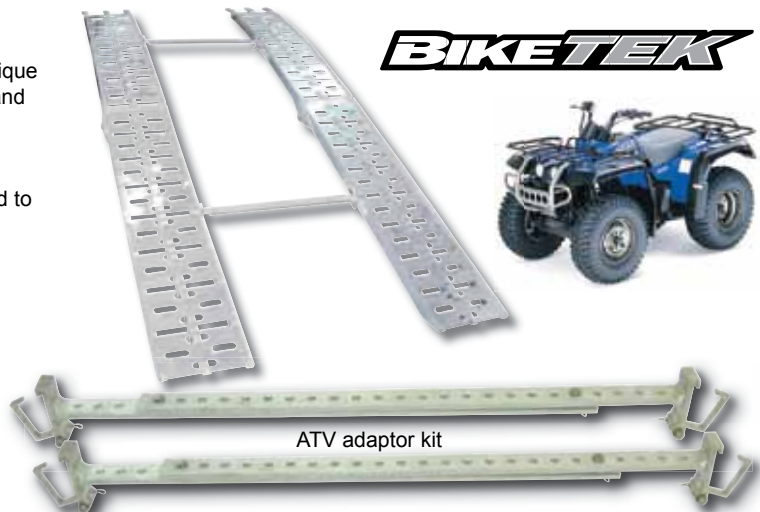

**BIKETEK**

ATV adaptor kit



## MX Scissor Lift

Robust and sturdy hydraulic lift stand. Foot-operated hydraulic ram, raises bike from platform height 340mm to maximum 830mm. Hard-wearing and grippy top mat protects bike frame, with feature cut out for drain hoses and oil drain access. Adjustable height legs. Drop-prevention safety bar. Screw-type footrest clamps secure bike to stand. Perfect for garages and workshop, but light enough to transport to tracks. Max load 140kgs.

Order Code: **PDSMX09**

**NEW**



Arriving  
Spring 2013

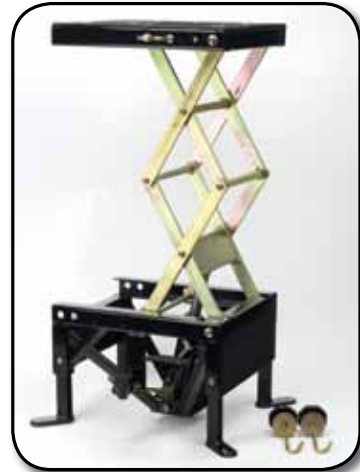

**BIKETEK**

## Scissor Lift

Heavy duty hydraulic stand lifts bikes from 340mm to 890mm

- Max lift 135kgs
- Foot lever operated
- Locking footrest springhooks
- Rubber top mat
- Fully CE approved
- Locking safety bar

Order Code: **PDSMX02**

**BIKETEK**

Do not confuse with  
lower specification  
models on the market.



Design may vary

## Self-assembly Wheel Chock

### Self-assembly Wheel Chock

Supports front wheel of bike during storage and transit. Fully adjustable to fit wheels 12" to 18" (adaptor kit available to convert to 21").

Features pivot clamp which locks the front wheel securely by the bike's weight. Can be bolted to ground.

Order Code: **PDSCHK17**

### 21" Wheel Adaptor Kit

Replacement support strut converts the self-assembly wheel chock to fit wheels up to 21".

Order Code: **PDSCHK19**

Note: Bike must also be secured using tie-down straps



### Moto-X H Stand

Minimal design MX lift stand which is strong and durable.

- Foot operated
- Rubber overlays on support struts
- Integral damper for controlled descent

Max Height - 420mm  
Max load - 150kgs

Order Code: **PDSMX08**



### Moto-X H Stand

Minimal design MX lift stand which is strong and durable.

- Foot operated
- Rubber overlays on support struts

Max Height - 435mm  
Min Height - 305mm  
Max load - 150kgs

Order Code: **PDSMX06**



### Moto-X Lift

Heavy-duty steel foot lift, suitable for all off-road bikes - from 60cc to 600cc +

- Manually operated lifting arm
- Rubber matted top-plate for increased grip

Max Height - 395mm  
Min Height - 310mm  
Max load - 150kgs

Order Code: **PDSMX01**



### Ridge Stands

Ridge stands provide a solid platform to load MX bikes onto for storage, or for maintenance and washing.

Manufactured from zinc plated steel, the stands are extremely durable and long-lasting.

Features rubberised non-slip top plate and side graffix boards.

Available in 3 sizes from kids to 125cc plus.

Order Code	Description
<b>PDSRDG01</b>	Mini Ridge Stand (>65cc)
<b>PDSRDG03</b>	Midi Ridge Stand (>100cc)
<b>PDSRDG05</b>	Large Ridge Stand (125cc>)

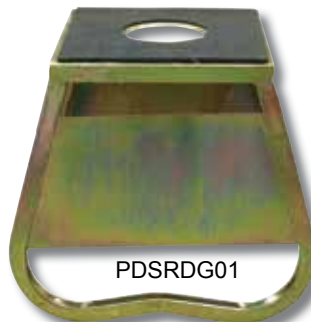

30cm



38cm



44cm



### Triangle Axle Stands

A simple but effective and space saving MX bike stand.

Constructed from heavy-duty steel and zinc coated for protection and longevity.

Order Code	Description
<b>PDSMX04</b>	Rear axle on 18" & 19" wheels
<b>PDSMX03</b>	Side frame on smaller MX bikes (up to 85cc)

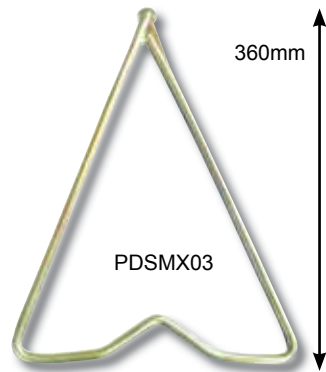

360mm

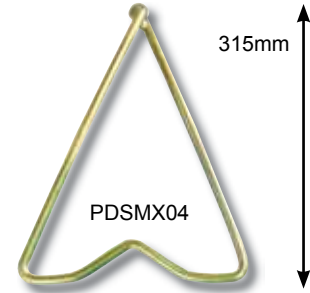

315mm





### Transformer Fairing Headlight

Universal off-road fairing headlight with integral LED indicator function. Twin 12V 20W (MR11) headlight bulbs. Amber LED insets for indicator function. Fitting Kit Included.

Order Code: **HLUTNFBLK**



### Raider Fairing Headlight

Universal plastic fairing headlight with four rubber mounting brackets for fork fitting. 12v 35/35w bulb with separate 12v 5w parking light.

Order Code	Colour
<b>HLURAI</b>	Black
<b>HLURAIU</b>	Blue
<b>HLURAIR</b>	Red
<b>HLURAIW</b>	White



**Replacement Bulbs**  
**BLB37** Headlight 12v 35/35w BA20D  
**BLB34** Parking Light 12v 5w

Fitting kit Included

### Rage Enduro Fairing Headlight

Universal off-road fairing headlight with twin bulbs and contrast coloured shield.

Order Code	Shield Colour
<b>HLURAGBLK</b>	Black
<b>HLURAGW</b>	White
<b>HLURAGBU</b>	Blue

**Replacement Bulbs**  
 Order Code Description  
**BLB32** Centre bulb MR16 12v20w

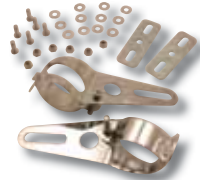

Fitting Kit Included



### Spectre Fairing Headlight

Universal fairing headlight with dual 12v 35w lamps set behind an acrylic protector lens. Features unique LED pods (10 white LED's per pod) on each side for additional illumination. Supplied with universal mounting rubbers.

Order Code	Colour
<b>HLUSPEBLK</b>	Black
<b>HLUSPEBU</b>	Blue
<b>HLUSPER</b>	Red
<b>HLUSPEW</b>	White
<b>HLUSPEY</b>	Yellow

**BLB43** Replacement headlight bulb (12v35w)

Fitting Kit Included



## Vertica Fairing Headlight

Universal "Vertica" headlight fairing. Durable plastic fairing unit with twin vertical mounted lamps (12v 20w bulbs,) set behind protective dome. Complete with mounting rubbers.

Order Code    Colour  
**HLUVERBLK**    Black

Upgrade from standard bulbs to convex type with easy install kits.

Order Code    Description  
**BLB23**        Convex blue projector bulb  
**BLB24**        Convex clear projector bulb



Fitting Kit Included



## Alien Enduro Fairing Headlight

Universal Enduro fairing headlight supplied with mounting rubbers and twin 12v 35 watt bulbs.

Order Code    Colour  
**HLUENDBLK**    Black  
**HLUENDBU**    Blue  
**HLUENDGY**    Grey  
**HLUENDR**     Red  
**HLUENDY**     Yellow

Replacement Bulb  
**BLB21**        Halogen12v  
                   35w



Fitting Kit Included



## Dart Fairing Headlight

Universal fitting durable plastic fairing headlight.  
 12V 35/35W bulb with separate 12V 5W parking light  
 Four rubber fork-mounting brackets supplied

Order Code    Colour  
**HLUDARBLK**    Black  
**HLUDARBU**    Blue  
**HLUDARGN**    Green  
**HLUDAROR**    Orange  
**HLUDARR**     Red  
**HLUDARW**     White  
**HLUDARY**     Yellow

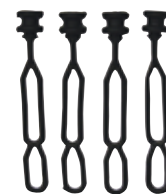

Fitting kit Included



## EMX Headlight (E Marked)

Order Code    Colour  
**8660600001**    Blue  
**8660600005**    Green  
**8660600006**    White  
**8660600007**    Yellow  
**8660600008**    Red  
**8660600010**    Black

Fitting Rubbers  
 Order Code    Description  
**HLBEMX**        Replacement Fitting Rubber  
                   (1pc)

Replacement Bulbs  
**BLB36**        12v 4w T8.5 BA9S  
**BLB37**        12v 35/35w BA20D



Fitting Kit Included

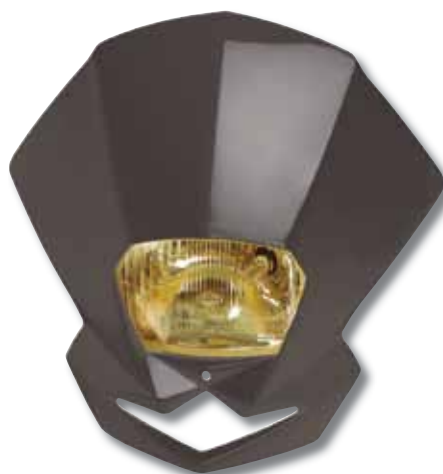



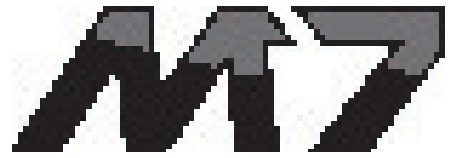

Using only the highest quality materials available, the M7 is built to last. Our exclusive use of a stainless steel spiral perforated core, designed further enhances the sound attenuation properties of the muffler, while still increasing the HP and torque of each model. All systems include 6061 AL muffler with magnesium endcaps, and removable spark arrestors, and link pipe.



**MX M7 Aluminium Slip-on Systems**

MAKE & MODEL	YEAR	ORDER CODE
<b>HONDA</b>		
CRF450R	11-12	<i>E005-3060406V</i>
CRF450R	09-10	<i>E005-2340406V</i>
CRF450X	05-12	<i>E005-1330406V</i>
CRF250R	11-12	<i>E005-3070406V</i>
CRF250R	10	<i>E005-2660406V</i>
<b>YAMAHA</b>		
YZ450F	10-12	<i>E005-2690406V</i>
YZ450F	07-09	<i>E005-1650406V</i>
YZ250F	10-12	<i>E005-2680406V</i>
YZ250F	07-09	<i>E005-1640406V</i>
<b>KTM</b>		
450SX-F	07-09	<i>E005-1840406V</i>
250SX-F	09	<i>E005-1840406V</i>
<b>SUZUKI</b>		
RMZ450	08-12	<i>E005-2250406V</i>
RMZ250	10-12	<i>E005-2670406V</i>
RMZ250	07-09	<i>E005-1620406V</i>
<b>KAWASAKI</b>		
KX450F	12	<i>E005-3150406V</i>
KX450F	09-10	<i>E005-2360406V</i>
KX250F	09-12	<i>E005-2350406V</i>
KX250F	06-08	<i>E005-1340406V</i>



Each kit includes exhaust can and link pipe.

**ATV M7 Aluminium Slip-on Systems**

MAKE & MODEL	YEAR	ORDER CODE
<b>HONDA</b>		
TRX450R	06-12	<i>E005-1440406V</i>
TRX400EX	08-12	<i>E005-2260406V</i>
<b>YAMAHA</b>		
YFZ450R	09-12	<i>E005-2430406V</i>
YFZ450	04-12	<i>E005-1050406VH</i>
Raptor 700	06-12	<i>E005-1380406V</i>





## Exhaust Packing Sheets

Easy-use sheets of sound absorption media, manufactured from highly voluminised continuous filament glass yarn using sophisticated texturisation techniques. Suitable for both street and off-road applications.

The material is uniquely compressed and stitched together with a fine low temperature melting thread, which dissolves on contact with exhaust gas, releasing the compressed fibres to expand and fully fill chamber voids. Ideally suited for repacking non-uniform shaped cans such as oval and tri-oval, which can be tricky to repack correctly with standard materials.

### Easy to use:

- > available in 3 lengths to suit most popular exhaust sizes (length can also be trimmed for precision)
- > no need to use stainless steel wool to cover the perforated pipe
- > simply wrap sheet around the perforated pipe and cut to attain the required fill volume (each sheet is 1M wide)

### Material benefits:

- > higher temperature resistance (up to 1000°C), eliminating need for s/s wool
- > high resistance to High Pulse Compacting
- > increased sound absorption compared to traditional materials
- > improved thermal insulation - reduced need for internal or external heat shields
- > more efficient than conventional needle mat or blown-in fibre products

Order Code	Size
<b>EXCPCK350</b>	350mm x 1M
<b>EXCPCK400</b>	400mm x 1M
<b>EXCPCK450</b>	450mm x 1M

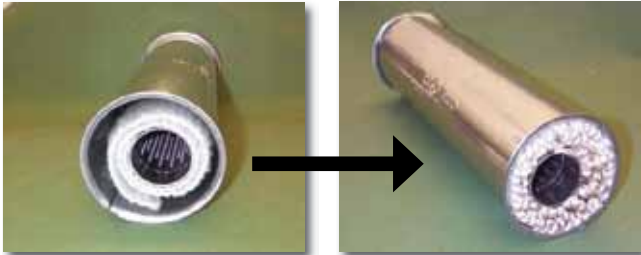

Fibres compressed by melting thread

Fibres expanded after thread has melted



## Exhaust Protector Shield

Exhaust protector shield contours to the shape of exhaust and attached by the four clamps provided. Offers protection from roost chipping and damage. 61cm length, available in two colour finishes

Order Code	Size
<b>EXCPROBK</b>	Black
<b>EXCPROS</b>	Silver



## Exhaust Bung

Protects silencer and engine by stopping water running down through the exhaust during washing.



**4 Stroke**  
Order Code:  
**EXHB001**

**2 Stroke**  
Order Code:  
**EXHB003**

## Universal MX / Quad Cans

Viper alloy sleeve can with carbon fibre end-cap, suitable for off-road use on quads and MX bikes.

With a standard inlet 51mm ID, the cans are easily mounted to original pipe work, a reducer kit is available separately to allow fitment to smaller pipework.

The carbon fibre end cap neatly finishes the can ensuring that there is no protruding outlet, making the can suitable for track use.

Features a removable baffle



Order Code	Description
<b>EXC759</b>	Stubby Oval Can (39cm) with Carbon Fibre End Cap and Removable Baffle
<b>EXCRDC08</b>	Exhaust inlet reducer kit includes 3 inter-changeable sleeves to allow exhaust fitment to narrower pipes. Minimum closure 44mm.
<b>EXC701</b>	Alloy Oval Stubby (39cm)



## Swivel Exhaust Springs

Swivel exhaust springs supplied in pairs, available in 57mm, 75mm, 83mm and 90mm lengths

Order Code	Size
<b>EXCSPR57</b>	57mm
<b>EXCSPR75</b>	75mm
<b>EXCSPR83</b>	83mm
<b>EXCSPR90</b>	90mm

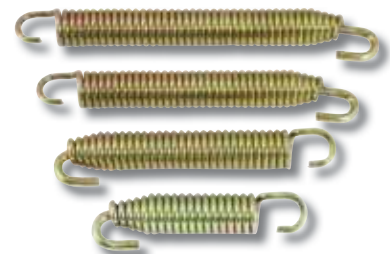

### Grip Donuts

Chunky neoprene cushions slide onto grips to provide extra cushioning for thumbs. Prevents chafing and blisters. Pair.

Order Code	Description
GRPDNT02	Honda
GRPDNT04	Kawasaki
GRPDNT08	Suzuki
GRPDNT10	Yamaha



### Grip Glue

5ml tube of lubricant adhesive for ease of installation and secure fitment of grips.  
Order Code: **GRPGLU5**



### Grip Sleeve / Clean Grips

Use clean-grips over existing handlebar grips to protect from oil and dirt. These are ideal for when the bike is being repaired or maintained, when oily hands can ruin the grips. Great for sports bikes and off-riders. Pair.

Order Code	Description
GRPSL01	Honda
GRPSL02	Kawasaki
GRPSL03	Suzuki
GRPSL04	Yamaha



### MotoX Competition Grips

Order Code	Colour
GRPMX11BU	Blue
GRPMX11GN	Green
GRPMX11GY	Grey
GRPMX11OR	Orange
GRPMX11R	Red
GRPMX11Y	Yellow



### Off Road - Pairs



**Matrix Off-Road - Dual Compound**  
Order Code: **GRPMX07**



**Black Doherty**  
Order Code: **GRPBRDOH**



**Matrix ATV Quad / Jetski**  
22mm left & right  
Order Code: **GRPQD07**



**Black Honda Type ATV Quad / Jetski**  
22mm left & right  
Order Code: **GRPQD12**



Order Code	Colour
GRPORBU	Blue
GRPORGRY	Grey
GRPORR	Red
GRPORPY	Yellow
GRPORGN	Green
GRPOROR	Orange

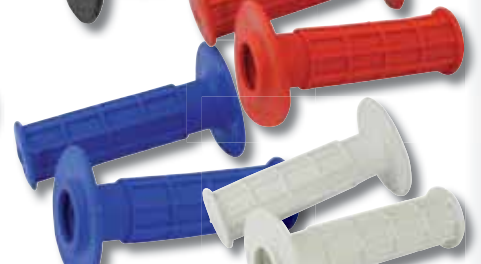

Order Code	Colour
GRPMXBLK	Black
GRPMXBU	Blue
GRPMXR	Red
GRPMXWH	White
GRPMXPK	Pink





**Handlebar Mounting Kit**

CR / KX style aluminium handlebar mounting clamps.  
 Precision quality CNC machined base and top clamp sections.  
 Premium polished finish.  
 Includes all fittings.  
 Available for 22.2mm and 28.6mm bar sizes.

Order Code *Fitment*  
**BARRIS12** 22.2mm bar type  
**BARRIS14** 28.6mm bar type



**28.6mm Handlebar Clamp Conversion**

Aluminium and CNC finished handlebar clamp, converts 22.2mm bar clamps to wider 28.6mm size, enabling use of jumbo bars of 28.6mm diameter.

Order Code:  
**BARRIS06**



**Multi-Stage Handlebar Riser Kit**

Aluminium handlebar riser kits  
 Precision quality CNC machined components  
 Premium polished finish

Features base mount, bar mount and three sizes of spacer  
 Includes three sets of M8 fitting bolts for various height options  
 4 height options (+5mm, +10mm, +15mm, +30mm)

Uses the original bar top clamp  
 Available for 22.2mm and 28.6mm bar sizes

Order Code *Fitment*  
**BARRIS08** 22.2mm bar type  
**BARRIS10** 28.6mm bar type



**Motocross Bar End**

Round 13.8mm alloy. Fits all 22mm / 7/8" bars with 14mm internal diameter. Pair

Order Code: **BEWMXCH**



**Bar End Weights**

Pairs of anti-vibration bar-end weights.  
 Fits all bars with 13mm internal diameter.  
 Complete with Allen Key.

**ROUND - 13mm**

Order Code *Colour*  
**BEWRN13BLK** Black  
**BEWRN13BU** Blue  
**BEWRN13CH** Chrome  
**BEWRN13GD** Gold  
**BEWRN13R** Red  
**BEWRN13CBN** Carbon look



**Handlebar Risers**

Aluminium and CNC finished handlebar riser clamps, raises bar height by 30mm. Available for 22.2mm and 28.6mm bar clamps

Order Code *Fitment*  
**BARRIS02** 28.6mm handlebar  
**BARRIS04** 22.2mm handlebar



**Bar Pads**

Order Code *Description*  
**BARPAD01** Honda Red  
**BARPAD02** Kawasaki Green  
**BARPAD04** Suzuki Yellow  
**BARPAD05** Yamaha Blue  
**BARPAD06** Black  
**BARPAD07** Red  
**BARPAD08** Union Jack



## Handlebar Accessory Mount Top Clamp

**NEW**

A clever and simple solution for mounting accessories such as Sat-Navs and cameras to a motorcycle. This replacement top clamp features an extended arm with a thread mount to enable accessories to be bolted on. The top clamp will fit 22.2mm bars. Available with either M6 x 1.0 or M8 x 1.25 mounting thread. Precision CNC machined alloy with anodised gunmetal finish.



Order Code	Description
<b>BARMNT05</b>	M6 x 1.0 thread mount
<b>BARMNT10</b>	M8 x 1.25 thread mount

## Flush Fit Bar End Weights

Flush-fitting universal bar end weights. Includes reducer sleeves to enable dual fitment to 18mm and 13mm bar inners. Available in 5 colour options. With feature Biketek print.

Order Code	Colour
<b>BEWFLSBK</b>	Black
<b>BEWFLSBU</b>	Blue
<b>BEWFLSGD</b>	Gold
<b>BEWFLSR</b>	Red
<b>BEWFLSS</b>	Silver



## Handlebar Accessory Mount Bracket

**NEW**

Designed to provide a perch for accessories that have a 22.2mm tube mounting bracket, such as Sat-Navs, smart phones and cameras. The 22.2mm diameter perch sits on an adjustable arm, the bracket has a 10mm bolt hole enabling fitment to many mounts such as mirror boss and lever clamps.



Order Code: **BARMNT15**

## Folding Bar Fitment Mirrors



Mini folding - 7/8" bar fitting  
**MRU001L** LEFT  
**MRU001R** RIGHT

## Handlebars

### Low Braced Bar

- Shot peen finish
- 22.2mm (7/8") diameter
- Width: 810mm
- Rise: 30mm
- Height: 45mm
- 6061 T6 Aluminium

Order Code	Colour
<b>HBM01BLK</b>	Black
<b>HBM01BU</b>	Blue
<b>HBM01GD</b>	Gold
<b>HBM01R</b>	Red
<b>HBM01SL</b>	Silver

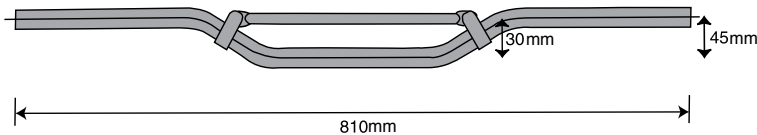

### Medium Braced Bar

- Shot peen finish
- 22.2mm (7/8") diameter
- Width: 740mm
- Rise: 47mm
- Height: 91mm
- 6061 T6 Aluminium

Order Code	Colour
<b>HBM03BLK</b>	Black
<b>HBM03BU</b>	Blue
<b>HBM03GD</b>	Gold
<b>HBM03R</b>	Red
<b>HBM03SL</b>	Silver

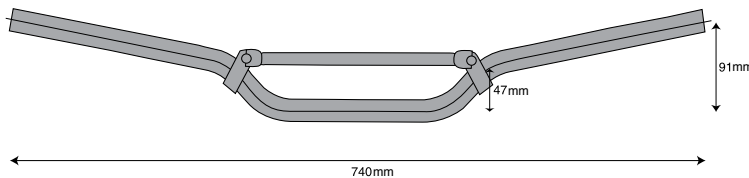

NB: All bars have an approximate ID of 14mm and will accept 13mm bar ends.

### Jumbo Off-Road Braced Bar

- 28.6mm clamp section for use with 1 1/8" top clamps
- 22.2mm (7/8") diameter
- Width: 802mm
- Rise: 65mm
- Height: 99mm
- 6061 T6 Aluminium

Order Code	Description
<b>BARJBBLK</b>	Matt Black
<b>BARJBBU</b>	Blue
<b>BARJBSL</b>	Matt Silver

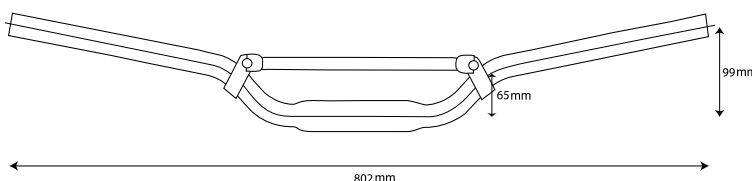



### Sprite Rally Brush Guards

- Complete with mounting kit for 22mm and 28 bars
- Available in Black, Blue, Red & White

<i>Order Code</i>	<i>Colour</i>
<b>BRG09BLK</b>	Black
<b>BRG09BU</b>	Blue
<b>BRG09R</b>	Red
<b>BRG09W</b>	White



### Patriot Hand Guards

- Handlebar mounted guard kits
- Offers basic hand and control protection
- High impact resistant plastic
- Universal fitment
- Full fitting kit included

<i>Order Code</i>	<i>Colour</i>
<b>BRG07BLK</b>	Black
<b>BRG07BU</b>	Blue
<b>BRG07R</b>	Red
<b>BRG07WH</b>	White



### Original Hand Guards

- Handlebar mounted guard kits
- High impact resistant plastic
- Protects hands and controls
- Universal fitment complete with 14mm & 18mm bar ends
- Full fitting kit included

<i>Order Code</i>	<i>Colour</i>
<b>BRGBLK</b>	Black
<b>BRGBU</b>	Blue
<b>BRGGN</b>	Green
<b>BRGR</b>	Red
<b>BRGWH</b>	White
<b>BRGY</b>	Yellow



### Vented Hand Guards

- Handlebar mounted guard kits
- High impact resistant plastic
- Protects hands and controls
- Universal fitment complete with 14mm & 18mm bar ends
- Full fitting kit included

<i>Order Code</i>	<i>Colour</i>
<b>BRG01BLK</b>	Black
<b>BRG01BU</b>	Blue
<b>BRG01GN</b>	Green
<b>BRG01R</b>	Red
<b>BRG01WH</b>	White
<b>BRG01Y</b>	Yellow



### Venom Reinforced Hand Guards

Venom hand guards feature an aluminium protective bar set into the guard for additional protection.

Includes 13mm & 17mm bar end fitting kit. Fits standard and fat bars.

<i>Order Code</i>	<i>Colour</i>
<b>BRG03BLK</b>	Black
<b>BRG03BU</b>	Blue
<b>BRG03GN</b>	Green
<b>BRG03OR</b>	Orange
<b>BRG03R</b>	Red
<b>BRG03WH</b>	White
<b>BRG03Y</b>	Yellow



### Champion Reinforced Hand Guards

Champion hand guards feature an aluminium protective bar for greater protection of hands and controls. Includes 13mm & 17mm bar end fitting kit.

<i>Order Code</i>	<i>Colour</i>
<b>BRG05BLK</b>	Black
<b>BRG05BU</b>	Blue
<b>BRG05R</b>	Red
<b>BRG05WH</b>	White



## MX Clutch & Brake Levers

- a full range of standard direct OEM replacement levers for MX and off-road models
- clutch and brake levers sold individually
- supplied in same colour finish as OEM lever (alloy or black)



MODEL	CLUTCH YEAR	FINISH	CLUTCH Order Code	BRAKE YEAR	FINISH	BRAKE Order Code
<b>HONDA</b>						
CR 80	86-97	Black	<i>LMXC08</i>	86-97	Alloy	<i>LMXB01</i>
CR 80	98-02	Alloy	<i>LMXC02</i>	98-02	Alloy	<i>LMXB03</i>
CR 85	98-08	Alloy	<i>LMXC02</i>	98-08	Alloy	<i>LMXB03</i>
CRF 100 F	04>	Alloy	<i>LMXC06</i>	04>	Alloy	<i>LMXB05</i>
XR 100 R	96-03	Alloy	<i>LMXC06</i>	96-03	Alloy	<i>LMXB05</i>
CR 125	92-95	Black	<i>LMXC08</i>	92-95	Black	<i>LMXB07</i>
CR 125	96-03	Alloy	<i>LMXC02</i>	96-03	Alloy	<i>LMXB03</i>
CR 125	04-08	Alloy	<i>LMXC04</i>	04-08	Alloy	<i>LMXB03</i>
CRF 150	07-08	Alloy	<i>LMXC02</i>	07-08	Alloy	<i>LMXB03</i>
CR 250	92-95	Black	<i>LMXC08</i>	92-95	Black	<i>LMXB07</i>
CR 250	96-03	Alloy	<i>LMXC02</i>	96-03	Alloy	<i>LMXB03</i>
CR 250	04-08	Alloy	<i>LMXC04</i>	04-08	Alloy	<i>LMXB03</i>
CRF 250	04-06	Alloy	<i>LMXC04</i>	04-06	Alloy	<i>LMXB03</i>
CRF 250	07-08	Alloy	<i>LMXC04</i>	07-08	Alloy	<i>LMXB27</i>
XR 250 R	96-06	Alloy	<i>LMXC02</i>	96-06	Alloy	<i>LMXB03</i>
XR 400 R	96-06	Black	<i>LMXC08</i>	96-06	Black	<i>LMXB07</i>
CRF 450	02-03	Alloy	<i>LMXC02</i>	02-03	Alloy	<i>LMXB03</i>
CRF 450	04-06	Alloy	<i>LMXC04</i>	04-06	Alloy	<i>LMXB03</i>
CRF 450	07-08	Alloy	<i>LMXC04</i>	07-08	Alloy	<i>LMXB27</i>
CRF 450 X	05>	Alloy	<i>LMXC04</i>	05>	Alloy	<i>LMXB03</i>
CR 500	87-95	Black	<i>LMXC08</i>	87-95	Black	<i>LMXB07</i>
CR 500	96-02	Alloy	<i>LMXC02</i>	96-02	Alloy	<i>LMXB03</i>
XR 650 R	00-05	Black	<i>LMXC08</i>	00-05	Black	<i>LMXB07</i>
<b>KAWASAKI</b>						
KX60	84-04	Alloy	<i>LMXC10</i>	84-04	Alloy	<i>LMXB17</i>
KX65	99-10	Alloy	<i>LMXC14</i>	99-10	Alloy	<i>LMXB15</i>
KX 80	94-96	Alloy	<i>LMXC12</i>	94-96	Alloy	<i>LMXB09</i>
KX 80	97	Alloy	<i>LMXC12</i>	97	Alloy	<i>LMXB11</i>
KX 80	98-00	Alloy	<i>LMXC14</i>	98-00	Alloy	<i>LMXB11</i>
KX85	00-10	Alloy	<i>LMXC14</i>	00-10	Alloy	<i>LMXB15</i>
KX 100	91-96	Alloy	<i>LMXC12</i>	91-96	Alloy	<i>LMXB09</i>
KX 100	97	Alloy	<i>LMXC12</i>	97	Alloy	<i>LMXB11</i>
KX 100	98-99	Alloy	<i>LMXC14</i>	98-99	Alloy	<i>LMXB11</i>
KX 100	00-08	Alloy	<i>LMXC14</i>	00-08	Alloy	<i>LMXB15</i>
KX 125	93-96	Alloy	<i>LMXC14</i>	93-96	Alloy	<i>LMXB09</i>
KX 125	97-99	Alloy	<i>LMXC14</i>	97-99	Alloy	<i>LMXB11</i>
KX 125	00-04	Alloy	<i>LMXC14</i>	00-04	Alloy	<i>LMXB15</i>
KX 125	05>	Alloy	<i>LMXC18</i>	05>	Alloy	<i>LMXB15</i>
KDX 200	91-98	Alloy	<i>LMXC12</i>	91-98	Alloy	<i>LMXB09</i>
KDX 220	98-05	Alloy	<i>LMXC12</i>	89-06	Alloy	<i>LMXB09</i>
KLX 250	93-96	Alloy	<i>LMXC12</i>	93-96	Alloy	<i>LMXB09</i>
KX 250	91-96	Alloy	<i>LMXC14</i>	91-96	Alloy	<i>LMXB09</i>
KX 250	97-99	Alloy	<i>LMXC14</i>	97-99	Alloy	<i>LMXB11</i>
KX 250	00-04	Alloy	<i>LMXC14</i>	00-04	Alloy	<i>LMXB15</i>
KX 250	05-08	Alloy	<i>LMXC18</i>	05-08	Alloy	<i>LMXB15</i>
KX 250 F	04	Alloy	<i>LMXC14</i>	04	Alloy	<i>LMXB15</i>
KX 250 F	05-08	Alloy	<i>LMXC18</i>	05-08	Alloy	<i>LMXB15</i>
KLX 300	00-05	Alloy	<i>LMXC14</i>	00-05	Alloy	<i>LMXB09</i>
KX 450 F	05-08	Alloy	<i>LMXC18</i>	05-08	Alloy	<i>LMXB15</i>
KX 500	94-96	Alloy	<i>LMXC12</i>	92-96	Alloy	<i>LMXB09</i>



**MX Clutch & Brake Levers cont...**

MODEL	CLUTCH YEAR	FINISH	CLUTCH Order Code	BRAKE YEAR	FINISH	BRAKE Order Code
<b>KAWASAKI cont...</b>						
KX 500	97-99	Alloy	<b>LMXC14</b>	97-99	Alloy	<b>LMXB11</b>
KX 500	00-04	Alloy	<b>LMXC14</b>	00-04	Alloy	<b>LMXB15</b>
<b>SUZUKI</b>						
RM 65	03-10	Alloy	<b>LMXC14</b>	03-10	Alloy	<b>LMXB15</b>
RM 80	88-04	Alloy	<b>LMXC16</b>	88-04	Alloy	<b>LMXB19</b>
RM 85	89-04	Alloy	<b>LMXC16</b>	89-04	Alloy	<b>LMXB19</b>
RM 85 / L	05-08	Alloy	<b>LMXC14</b>	05-08	Alloy	<b>LMXB15</b>
RM 100	03-04	Alloy	<b>LMXC14</b>	05-08	Alloy	<b>LMXB15</b>
RM 125	88-95	Alloy	<b>LMXC16</b>	88-95	Alloy	<b>LMXB19</b>
RM 125	96-04	Alloy	<b>LMXC16</b>	96-04	Alloy	<b>LMXB03</b>
RM 125	05>	Alloy	<b>LMXC16</b>	05>	Alloy	<b>LMXB15</b>
RM 250	88-95	Alloy	<b>LMXC16</b>	88-95	Alloy	<b>LMXB19</b>
RM 250	96-04	Alloy	<b>LMXC16</b>	96-04	Alloy	<b>LMXB03</b>
RM 250	05>	Alloy	<b>LMXC16</b>	05>	Alloy	<b>LMXB15</b>
RMX 250	89-99	Alloy	<b>LMXC16</b>	89-99	Alloy	<b>LMXB19</b>
RM-Z 250	89-98	Alloy	<b>LMXC16</b>	89-98	Alloy	<b>LMXB19</b>
RM-Z 250	04	Alloy	<b>LMXC14</b>	04	Alloy	<b>LMXB15</b>
RM-Z 250	05>	Alloy	<b>LMXC18</b>	05>	Alloy	<b>LMXB15</b>
DR-Z 400 S	00-04	Alloy	<b>LMXC16</b>	00-04	Alloy	<b>LMXB03</b>
RM-Z 450	04	Alloy	<b>LMXC14</b>	04	Alloy	<b>LMXB15</b>
RM-Z 450	05>	Alloy	<b>LMXC18</b>	05>	Alloy	<b>LMXB15</b>
<b>YAMAHA</b>						
YZ 80	87-96	Alloy	<b>LMXC20</b>	87-96	Alloy	<b>LMXB23</b>
YZ 80	97-00	Alloy	<b>LMXC20</b>	97-00	Alloy	<b>LMXB21</b>
YZ 80	01-08	Alloy	<b>LMXC20</b>	01-08	Alloy	<b>LMXB15</b>
YZ 85	01-02	Alloy	<b>LMXC20</b>	01-02	Alloy	<b>LMXB15</b>
YZ 85	03>	Alloy	<b>LMXC18</b>	03>	Alloy	<b>LMXB15</b>
YZ 100	86	Alloy	<b>LMXC20</b>	86	Alloy	<b>LMXB23</b>
YZ 125	87-99	Alloy	<b>LMXC20</b>	96-99	Alloy	<b>LMXB21</b>
YZ 125	00	Alloy	<b>LMXC18</b>	00	Alloy	<b>LMXB21</b>
YZ 125	01-07	Alloy	<b>LMXC18</b>	01-07	Alloy	<b>LMXB15</b>
YZ 125	08>	Alloy	<b>LMXC18</b>	08>	Alloy	<b>LMXB25</b>
TT-R 250	99-06	Alloy	<b>LMXC20</b>	99-06	Alloy	<b>LMXB23</b>
YZ 250	87-99	Alloy	<b>LMXC20</b>	96-99	Alloy	<b>LMXB21</b>
YZ 250	00	Alloy	<b>LMXC18</b>	00	Alloy	<b>LMXB21</b>
YZ 250	01-07	Alloy	<b>LMXC18</b>	01-07	Alloy	<b>LMXB15</b>
YZ 250	08>	Alloy	<b>LMXC18</b>	08>	Alloy	<b>LMXB25</b>
YZ 250 F	01-06	Alloy	<b>LMXC18</b>	01-06	Alloy	<b>LMXB15</b>
YZ 250 F	07>	Alloy	<b>LMXC18</b>	07>	Alloy	<b>LMXB25</b>
WR 250 F	01-06	Alloy	<b>LMXC18</b>	01-06	Alloy	<b>LMXB15</b>
WR 250 F	07-08	Alloy	<b>LMXC18</b>	07-08	Alloy	<b>LMXB25</b>
YZ 400 F	98-99	Alloy	<b>LMXC20</b>	98-99	Alloy	<b>LMXB21</b>
WR 400 F	98-99	Alloy	<b>LMXC20</b>	98-99	Alloy	<b>LMXB21</b>
WR 400 F	00	Alloy	<b>LMXC18</b>	00	Alloy	<b>LMXB21</b>
YZ 426 F	00	Alloy	<b>LMXC18</b>	00	Alloy	<b>LMXB21</b>
WR 426 F	00	Alloy	<b>LMXC18</b>	00	Alloy	<b>LMXB21</b>
YZ 426 F	01-02	Alloy	<b>LMXC18</b>	01-02	Alloy	<b>LMXB15</b>
WR 426 F	01-02	Alloy	<b>LMXC18</b>	01-02	Alloy	<b>LMXB15</b>
YZ 450 F	03-07	Alloy	<b>LMXC18</b>	03-07	Alloy	<b>LMXB15</b>
YZ 450 F	08>	Alloy	<b>LMXC18</b>	08>	Alloy	<b>LMXB25</b>
WR 450 F	03-07	Alloy	<b>LMXC18</b>	03-07	Alloy	<b>LMXB15</b>
WR 450 F	08>	Alloy	<b>LMXC18</b>	08>	Alloy	<b>LMXB25</b>

**MX Clutch & Brake Levers cont...**



Order Code: **LMXB01**



Order Code: **LMXB03**



Order Code: **LMXB05**



Order Code: **LMXB07**



Order Code: **LMXB09**



Order Code: **LMXB11**



Order Code: **LMXB15**



Order Code: **LMXB17**

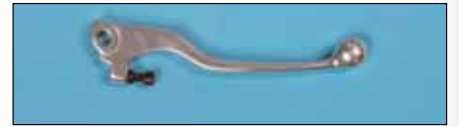

Order Code: **LMXB19**



Order Code: **LMXB21**



Order Code: **LMXB23**



Order Code: **LMXB25**



Order Code: **LMXB27**



Order Code: **LMXC02**

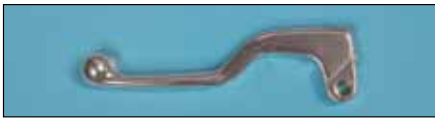

Order Code: **LMXC04**

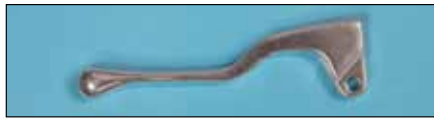

Order Code: **LMXC06**



Order Code: **LMXC08**



Order Code: **LMXC10**



Order Code: **LMXC12**



Order Code: **LMXC14**



Order Code: **LMXC16**



Order Code: **LMXC18**



Order Code: **LMXC20**



**Universal Short Lever Assemblies - Sets**

**Short alloy brake and clutch**  
Order Code: **LVR002SHT**



**Short alloy/black brake and clutch**  
Order Code: **LVR004SHT**



**Short black brake and clutch**  
Order Code: **LVR001SHT**



**Short red/blue brake and clutch**  
Order Code: **LVR003BU**

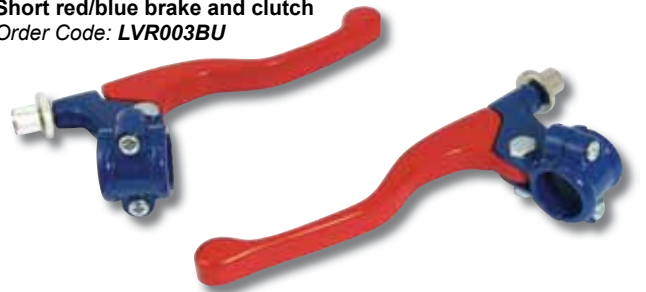

**Short red/white brake and clutch**  
Order Code: **LVR003W**

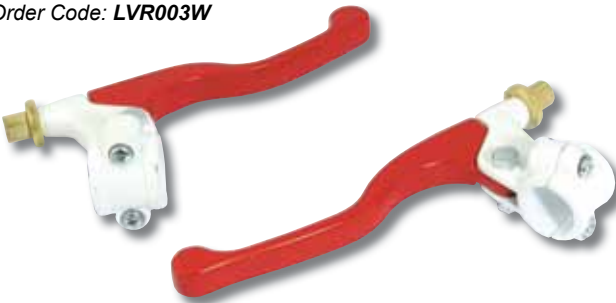

**OEM Replacement Levers**

Fit all CR, ATC, CRM, TLR, TRX & XR models

**LEVER MOUNTS**

Code	Description
<b>LVRHCMALL</b>	Alloy lever mount
<b>LVRHCMBLK</b>	Black lever mount

**CLUTCH BLADES**

Code	Description
<b>LVRHCBALL</b>	Long alloy clutch blade
<b>LVRHCBBLK</b>	Short black clutch blade
<b>LVRHCBBLKL</b>	Long black clutch blade



**Universal Long Lever Assemblies**

**Long alloy clutch**  
Order Code: **LVR002LNGC**



**Clutch with mirror boss**  
Order Code: **LVR006BOSS**



**Clutch without mirror boss**  
Order Code: **LVR006WOB**



**Long alloy/black brake and clutch set**  
Order Code: **LVR004LNG**



**Long alloy brake and clutch set**  
Order Code: **LVR002LNG**

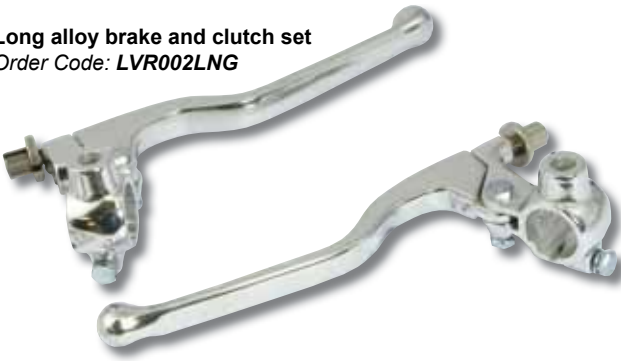

**Long black brake and clutch set**  
Order Code: **LVR001LNG**



## Throttle Sleeves

OEM replacement throttle sleeves for the majority of off-road bikes. Manufactured from hard-wearing non-shatter reinforced plastic.



Model	Year	Order Code
<b>HONDA</b>		
CR80	85-00	THRSLV04
CR85	03-07	THRSLV04
CR125R	04-07	THRSLV08
CR125R	89-02	THRSLV08
CR250R	89-07	THRSLV08
CRF250R/X	04-11	THRSLV12
CRF450R	02-11	THRSLV12
CRF450X	05-07	THRSLV12
CR500R	89-01	THRSLV08

<b>KAWASAKI</b>		
KX125	92-05	THRSLV16
KX250	92-07	THRSLV16
KX250F	04-12	THRSLV20
KX450F	07-11	THRSLV20

Model	Year	Order Code
<b>KTM</b>		
all models	97>	THRSLV08

<b>SUZUKI</b>		
RM125	95-07	THRSLV16
RM250	95-07	THRSLV16
RMXZ250	04-11	THRSLV20
RMZ450	05-11	THRSLV20

<b>YAMAHA</b>		
YZ125	96-12	THRSLV16
YZ250	96-12	THRSLV16
YZ250F	01-11	THRSLV20
WR250	97	THRSLV16
WR250F	01-12	THRSLV20
WR400F	98-00	THRSLV20
YZ400F	98-99	THRSLV20
YZ426F	00-02	THRSLV20
YZ450F	03-12	THRSLV20

## Teflon Lever Bracket Sleeves

These hard-wearing Teflon sleeves fit between the handlebar and lever bracket mount. In a crash or fall the teflon sleeve allows the lever bracket to rotate on the bar, reducing risk of snapping the lever and mount.

Order Code: **LVRSLV03**



## Silicone Lever Sleeves

Open-ended silicone sleeves simply pull over levers. Increases finger grip for greater control. Range of OEM colours. Sold in pairs.

Order Code	Colour
LVRSCN02	Black
LVRSCN04	Blue
LVRSCN06	Green
LVRSCN08	Orange
LVRSCN10	Red



## Rotating Bar Clamps

Fitting rotating bar clamps can prevent levers snapping on impact. Machined aluminium clamps feature a nylon inner sleeve which acts to allow the lever or master cylinder to rotate on the handlebar during a fall or knock.

Supplied individually, each pack contains one clamp, nylon sleeve and two stainless steel bolts. Available in black or titanium finish

Order Code	Colour
LVRROT01	Titanium
LVRROT03	Black





## Fuel Caps

Lightweight CNC machined alloy MX fuel caps with colour coded breather valves.

Make	Model	Year	Colour	Fits Tank Thread	Order Code
HONDA	CRF		BLACK	59mm	<b>FCX02BK</b>
HONDA	CRF		RED	59mm	<b>FCX02R</b>
HONDA	CRF		SILVER	59mm	<b>FCX02S</b>
HONDA	CR		BLACK	50mm	<b>FCX04BK</b>
HONDA	CR		RED	50mm	<b>FCX04R</b>
HONDA	CR		SILVER	50mm	<b>FCX04S</b>
HUSQVARNA			BLACK	47mm	<b>FCX01BK</b>
HUSQVARNA			SILVER	47mm	<b>FCX01S</b>
KAWASAKI	KX250	05>	BLACK	57mm	<b>FCX03BK</b>
KAWASAKI	KX250	05>	BLUE	57mm	<b>FCX03BU</b>
KAWASAKI	KX250	05>	SILVER	57mm	<b>FCX03S</b>
KAWASAKI	KX/KXF		BLACK	50mm	<b>FCX04BK</b>
KAWASAKI	KX/KXF		RED	50mm	<b>FCX04R</b>
KAWASAKI	KX/KXF		SILVER	50mm	<b>FCX04S</b>
KTM			BLACK	47mm	<b>FCX01BK</b>
KTM			SILVER	47mm	<b>FCX01S</b>
SUZUKI	RM/RMZ		BLACK	50mm	<b>FCX04BK</b>
SUZUKI	RM/RMZ		RED	50mm	<b>FCX04R</b>
SUZUKI	RM/RMZ		SILVER	50mm	<b>FCX04S</b>
YAMAHA	YZ	>02	BLACK	62mm	<b>FCX05BK</b>
YAMAHA	YZ	>02	BLUE	62mm	<b>FCX05BU</b>
YAMAHA	YZ	>02	SILVER	62mm	<b>FCX05S</b>
YAMAHA	YZ	03>	BLACK	57mm	<b>FCX03BK</b>
YAMAHA	YZ	03>	BLUE	57mm	<b>FCX03BU</b>
YAMAHA	YZ	03>	SILVER	57mm	<b>FCX03S</b>

Replacement Breather Valves / 10pcs MIXED colours  
Order Code: **FCX06**



## Security Bolts/Rim Locks

Security Rim Locks prevent tyre slippage on rim when inner tube is at lower pressure. Rubber coated to protect inner tube. Bolt holes may need to be drilled through rim for fitting.

- 1.6 fits most 21" tyres
- 1.85 fits most rear 125 wheels
- 2.15 fits most 200/250 rear wheels.

### Metal Backed

Order Code	Rim Size
<b>SBLMET160</b>	1.4 / 1.6
<b>SBLMET185</b>	1.85
<b>SBLMET215</b>	2.15
<b>SBLMET250</b>	2.50

### Rubber Backed

Order Code	Rim Size
<b>SBLRUB160</b>	1.4 / 1.6
<b>SBLRUB185</b>	1.85
<b>SBLRUB215F</b>	2.15 Front
<b>SBLRUB250</b>	2.50

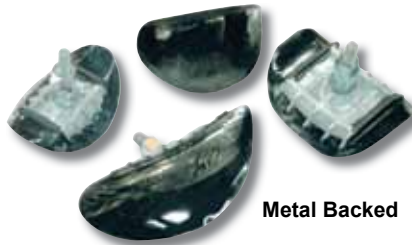

Metal Backed



Rubber Backed

## Rim Lock Nuts / Space Kit

Pairs of alloy spacers and nuts for securing security bolts / rim locks. Available in black and silver colour finishes

Order Code	Colour
<b>SBLNUTS</b>	Silver
<b>SBLNUTBK</b>	Black



## Foam Guard

This versatile foam block can be attached to parts of off-road bikes (such as radiators) to prevent build up and sticking of mud and sand.

Foam can be cut out to any required shape and size, simply fix with cable ties.

Size: 33x33x4cm



Order Code: **FOA008**

## Chain Rollers

Replacement chain rollers available in 3 sizes.

Order Code	Diameter	Colour
<b>CRL32Y</b>	32mm	Yellow
<b>CRL32BU</b>	32mm	Blue
<b>CRL32BK</b>	32mm	Black
<b>CRL32R</b>	32mm	Red
<b>CRL39BK</b>	39mm	Black
<b>CRL42BK</b>	42mm	Black



## GP-Pro Adult Helmets

### BLACK

Order Code	Size
HEL70XS	XS
HEL70S	Small
HEL70M	Medium
HEL70L	Large
HEL70XL	XL
HEL70XX	XXL
HEL70VIS	Replacement Visor

### BLUE

Order Code	Size
HEL72XS	XS
HEL72S	Small
HEL72M	Medium
HEL72L	Large
HEL72XL	XL
HEL72XX	XXL
HEL72VIS	Replacement Visor

### RED

Order Code	Size
HEL74XS	XS
HEL74S	Small
HEL74M	Medium
HEL74L	Large
HEL74XL	XL
HEL74XX	XXL
HEL74VIS	Replacement Visor

### YELLOW

Order Code	Size
HEL77XS	XS
HEL77S	Small
HEL77M	Medium
HEL77L	Large
HEL77XL	XL
HEL77XX	XXL
HEL77VIS	Replacement Visor

### GREEN

Order Code	Size
HEL78XS	XS
HEL78S	Small
HEL78M	Medium
HEL78L	Large
HEL78XL	XL
HEL78XX	XXL
HEL78VIS	Replacement Visor

### ORANGE

Order Code	Size
HEL79XS	XS
HEL79S	Small
HEL79M	Medium
HEL79L	Large
HEL79XL	XL
HEL79XX	XXL
HEL79VIS	Replacement Visor

- Lightweight aerodynamic thermoplastic alloy shell
- Double D-Ring padded retention system
- GP-PRO graphics
- Goggle grabbers
- ECE 22-05 / ACU GOLD
- Air channel ventilation system, mouth and rear vents
- Adjustable visor
- Complete with helmet bag
- Fully removable and washable cheek pads and lining



Helmet Size Chart

ADULT					
XS	S	M	L	XL	XXL
53-54cm	55-56cm	57-58cm	59-60cm	61-62cm	63 cm

## GP-Pro Helmet Liner

Order Code	Size
HEL17XS	XS
HEL17S	SMALL
HEL17M	MEDIUM
HEL17L	LARGE
HEL17XL	XL
HEL17XX	XXL



Replacement helmet liner kit for GP PRO MX helmet. Contains one liner and two cheek pads

Suitable for all GP Pro adult helmets

Size Chart

ADULT					
XS	S	M	L	XL	XXL
53-54cm	55-56cm	57-58cm	59-60cm	61-62cm	63 cm

## WSGG Standard Goggles

- Off-road competition goggle
- Classic shape with wide peripheral vision
- Durable and flexible polyurethane frame
- Contoured fit single foam padding
- Scratch resistant anti-fogging lens
- Inbuilt frame vents

Order Code	Colour
GOGWSGBK	Black
GOGWSGBU	Blue
GOGWSGG	Green
GOGWSGR	Red
GOGWSGY	Yellow



### REPLACEMENT LENSES

Replacement polycarbonate lenses for WSGG "standard" goggles. Scratch-resistant and anti-fogging.

Order Code	Colour	Pack Qty
LENSTDC	Clear	2
LENSTDI	Iridium	1
LENSTDS	Smoked	1

### TEAR-OFFS

10pc tear-off pack for standard goggles

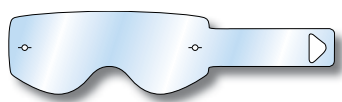

Order Code: GOGTOFSTD



Keep goggles clean with tear-offs for STANDARD models. Each pack contains 2 self-adhesive fixing stems, plus 10pcs of clear tear-off film. Stems simply stick to the outside of the goggle lens, the tear-off films clipping onto the stems. Suitable for use on all standard WSGG goggles and lenses.



## Jumbo Kit Bag

### Features

- 130L capacity
- Main storage compartment with dirty kit bag
- 2 end compartments suitable for helmets and boots
- Integral roll-out changing mat
- Travel wheels and retractable trolley handle
- Shoulder straps and carry handles
- 841 x 400 x 400mm



Travel Wheels



**130 litres**

Order Code: **LUGKITA**

## Midi Kit Bag

### Features

- 90L capacity
- Main storage compartment with dirty kit bag
- 2 end compartments
- Integral roll-out changing mat
- Shoulder straps and carry handles
- 701 x 350 x 350mm

Order Code: **LUGKITB**

**90 litres**



## Goggles Case

Reinforced shell protective storage case for MX goggles. Main compartment features adjustable dividers to fit up to 5 sets of goggles. Front zip flat-compartment and inner mesh pockets for lenses, cleaners and tear-offs.

Order Code **GGOBAG09**



## GP-Pro Goggles

- Off-road competition goggle
- Classic shape with wide peripheral vision
- Durable and flexible polyurethane frame
- Contoured fit triple fleece-foam padding
- Scratch resistant anti-fogging lens
- Lens mounted tear-off studs
- Silicone inlay helmet grabbers
- Inbuilt frame vents

Order Code    Colour  
**GOGPROBK**    Black  
**GOGPROBU**    Blue  
**GOGPROR**     Red



### TEAR-OFFS

10pc tear-off pack for GP-PRO goggles



Order Code: **GOGTOFFPRO**

Keep goggles clean with tear-offs for GP PRO models. Each 10pc pack includes separating papers and holes to allow attachment to GP PRO goggle tear off studs. Suitable for use on all GP PRO goggles and lenses.

## Biketek Hydration Pack

This Biketek hydration pack is a complete drinks system for use whilst on the move, perfect for green-laning, trail and road riding. The robust backpack features a well-sized main compartment with internal key pocket and a further 3 outer zip pockets, and MP3 headphone port. The 2 litre drinks bladder locates in a separate external section, with drinking-tube retainers on the shoulder straps. External bungee and quick release chassis enables trapping of spare clothing and luggage. Fully padded shoulder straps and back support, with chest and waist belts for snug fitment.

Order Code    Description

**LUGHYD07**    Hydration pack with 2L bladder

**LUGHYD09**    Replacement bladder 2L

**NEW**



## REPLACEMENT LENSES

Replacement polycarbonate lenses for GP-PRO goggles. Scratch-resistant and anti-fogging.

Order Code	Colour	Pack Qty
<b>LENPROC</b>	Clear	2
<b>LENPROI</b>	Iridium	1
<b>LENPROD</b>	Smoked	1

Clear anti-scratch outer lens and anti-fog inner lens.

**LENPROD** Double Lens 1



### Luggage Tool Roll

Tri-folding heavy duty nylon tool roll, featuring dividers and elastic retainers for tool storage. Includes fold out document pouch. 40 x 30cm opened.

**NEW**

Order Code: **LUGTLS13**



\* Tools not included

### Biketek Waist Bag

Ripstop nylon waistbag comprising main central compartment and two side pouches. Perfect storage for wallets, phones and keys whilst riding. 1.6 Litre capacity.

Order Code: **LUGBUM13**

**NEW**



### Helmet Carrier

A generous sized storage bag for one helmet plus kit and gloves  
 Central compartment for helmet storage  
 Two side zip pockets  
 Fleece lined for protection  
 Feature ventilation ducts allows kit to breathe and dry  
 Carry handle and hanger-loop

Order Code: **LUGHEL12**



### Neo Flex 2 Gloves

- Stretch neoprene cuff and knuckle
- Breathable mesh construction
- Reinforced thumb, palm and inset
- Padded protective GP-PRO logo panelling on upper and fingers
- Velcro cuff closure



**BLUE**  
 Order Code      Size  
**GLVMX08BUS**      Small  
**GLVMX08BUM**      Medium  
**GLVMX08BUL**      Large  
**GLVMX08BUXL**      XL  
**GLVMX08BU2XL**      2XL

**BLACK**  
 Order Code      Size  
**GLVMX08BKS**      Small  
**GLVMX08BKM**      Medium  
**GLVMX08BKL**      Large  
**GLVMX08BKXL**      XL  
**GLVMX08BK2XL**      2XL

**GREEN**  
 Order Code      Size  
**GLVMX08GNS**      Small  
**GLVMX08GNM**      Medium  
**GLVMX08GNL**      Large  
**GLVMX08GNXL**      XL  
**GLVMX08GN2XL**      2XL

**RED**  
 Order Code      Size  
**GLVMX08RS**      Small  
**GLVMX08RM**      Medium  
**GLVMX08RL**      Large  
**GLVMX08RXL**      XL  
**GLVMX08R2XL**      2XL

**ORANGE**  
 Order Code      Size  
**GLVMX08ORS**      Small  
**GLVMX08ORM**      Medium  
**GLVMX08ORL**      Large  
**GLVMX08ORXL**      XL  
**GLVMX08OR2XL**      2XL

ADULT GLOVES SIZE CHART				
SMALL	MEDIUM	LARGE	XL	2XL
17-19cm	20-22cm	23-24cm	25-27cm	28-30cm
8	9	10	11	12

### Vanguard Gloves

- Air mesh and honeycomb fabric uppers
- Rubberised protective logo panelling
- Reinforced thumb, palm and inset
- Velcro cuff closure

**BLUE**  
 Order Code      Size  
**GLVVANBUS**      Small  
**GLVVANBUM**      Medium  
**GLVVANBUL**      Large  
**GLVVANBUXL**      XL  
**GLVVANBUXX**      XXL

**YELLOW**  
 Order Code      Size  
**GLVVANYS**      Small  
**GLVVANYM**      Medium  
**GLVVANYL**      Large  
**GLVVANYXL**      XL  
**GLVVANYXX**      XXL

**BLACK**  
 Order Code      Size  
**GLVVANGYS**      Small  
**GLVVANGYM**      Medium  
**GLVVANGYL**      Large  
**GLVVANGYXL**      XL  
**GLVVANGYXX**      XXL

**GREEN**  
 Order Code      Size  
**GLVVANGNS**      Small  
**GLVVANGNM**      Medium  
**GLVVANGNL**      Large  
**GLVVANGNXL**      XL  
**GLVVANGNXX**      XXL

**RED**  
 Order Code      Size  
**GLVVANRS**      Small  
**GLVVANRM**      Medium  
**GLVVANRL**      Large  
**GLVVANRXL**      XL  
**GLVVANRXX**      XXL



ADULT GLOVES SIZE CHART				
SMALL	MEDIUM	LARGE	XL	2XL
17-19cm	20-22cm	23-24cm	25-27cm	28-30cm
8	9	10	11	12



## Neo Palm Pads

**NEW**

Neoprene pads protect palm by adding extra cushion between the hand and handlebar grip. Minimises friction which can cause blisters, increases grip and comfort. Sold as pair

Order Code: **PLMSAV13**



## ProGuard Gloves

- Premium off-road glove
- Breathable mesh construction
- Extra protective hard-shell knuckle
- GP-PRO logo protector pads on upper and fingers
- Reinforced padded thumb and palm sections
- Velcro cuff closure

Order Code    Size  
**GLVMX12S**    Small  
**GLVMX12M**    Medium  
**GLVMX12L**    Large  
**GLVMX12XL**    Extra Large  
**GLVMX122XL**    XXL



### ADULT GLOVES SIZE CHART

SMALL	MEDIUM	LARGE	XL	2XL
17-19cm	20-22cm	23-24cm	25-27cm	28-30cm
8	9	10	11	12

## Reflex Gloves

- Premium race glove
- Contoured fit with optimum flexibility
- Breathable mesh construction
- Reinforced padded thumb and palm sections
- GP-PRO logo protector pads on upper and fingers
- Lever-gripper inlays on index and middle digits
- Velcro cuff closure

### BLUE

Order Code    Size  
**GLVMX10BUS**    Small  
**GLVMX10BUM**    Medium  
**GLVMX10BUL**    Large  
**GLVMX10BUXL**    XL  
**GLVMX10BU2XL**    2XL

### BLACK

Order Code    Size  
**GLVMX10BKS**    Small  
**GLVMX10BKM**    Medium  
**GLVMX10BKL**    Large  
**GLVMX10BKXL**    XL  
**GLVMX10BK2XL**    2XL

### GREEN

Order Code    Size  
**GLVMX10GNS**    Small  
**GLVMX10GNM**    Medium  
**GLVMX10GNL**    Large  
**GLVMX10GNXL**    XL  
**GLVMX10GN2XL**    2XL

### RED

Order Code    Size  
**GLVMX10RS**    Small  
**GLVMX10RM**    Medium  
**GLVMX10RXL**    Large  
**GLVMX10RXL**    XL  
**GLVMX10R2XL**    2XL

### ORANGE

Order Code    Size  
**GLVMX10ORS**    Small  
**GLVMX10ORM**    Medium  
**GLVMX10ORL**    Large  
**GLVMX10ORXL**    XL  
**GLVMX10OR2XL**    2XL

### ADULT GLOVES SIZE CHART

SMALL	MEDIUM	LARGE	XL	2XL
17-19cm	20-22cm	23-24cm	25-27cm	28-30cm
8	9	10	11	12



## Short-sleeved Jacket Protector

Jacket protectors offer optimum upper torso protection and comfort for off road riding in one complete product.

This new model offers equivalent levels of protection for those riders who prefer to have their lower arms free

### Features:

- Breathable mesh inner jacket with front side zip
- Vented hardshell protectors on front torso and shoulders
- Impact-absorbent foam padding
- Removable back protector with interlocked hardshell panels
- Integral adjustable kidney belt
- EN approved

Order Code	Size
<b>PROMXJ26</b>	Adult S / M
<b>PROMXJ28</b>	Adult L / XL



## Jacket Protector

- Stretch mesh inner jacket
- Single piece chest protector with side-zip
- Injection moulded hardshell PP protectors
- Protectors on front-torso, shoulders, upper arm, elbow and lower arm
- Integral back protector
- Waist belt with velcro adjuster
- EN14021, EN1621-1, EN-1621-2 approved

Order Code	Size
<b>PROMXJ16</b>	Small/Medium
<b>PROMXJ18</b>	Large/XL
<b>PROMXJ20</b>	2XL>



## Premium Body Armour

Premium adult upper-body armour. Each set features chest, back, shoulder and upper arm protection, with velcro and buckle closures. EVA edge-lined for comfort fit and added protection.

- Made from ergonomically shaped polypropylene
- Vented for optimum airflow
- EVA edge-lined and inner panelled
- Nylon webbed floating shoulders
- Quick-Fit buckle closures
- Black body, silver shoulders, black arms

Order Code: **PROMX05**  
Colours subject to change





## Jacket Protector

- Lightweight breathable mesh inner jacket with zip front
- EVA foam with injection moulded hardshell PP protectors
- Protectors on front torso, shoulders, upper arm, elbow and lower arm
- Removeable back protector with EVA foam and interlocked moulded PP protectors
- Integrated kidney belt
- Adjustable velcro closures
- CE approved

Order Code Size  
**PROMXJ12** Small - Medium  
**PROMXJ14** Large - XL



## Back Protector

- Hardshell back protector (PP and EVA)
- Interlocked injection moulded plastic protectors
- Guards against knocks and over-extension
- Intergrated kidney belt
- Adjustable shoulder straps
- CE approved

Order Code Size  
**PROMXB04** Small - Medium  
**PROMXB06** Large - XL



## Protector Shorts

- Comfort inner shorts with fly opening
- Integrated EVA foam protectors on hips, thighs and rump
- Provides impact protection where needed

Order Code Size  
**PROMXT03** Small  
**PROMXT06** Medium  
**PROMXT09** Large  
**PROMXT12** XL



### ADULT SIZES

SIZE	S	M	L	XL
Waist	28-30"	32-34"	36-38"	40-42"

## Adult Track Coat

- Oversized track coat for wet and muddy meets
- Peaked drawstring hood
- Pass pouch on sleeve
- 2 waist pockets

Order Code Size  
**JCK06M** Small / Medium  
**JCK06L** Large / XL



## GP-Pro Kidney Belt

- Ergonomic designed adult kidney belt
- Provides support for lower back and torso
- Reinforced ventilated back chassis
- Dual elasticated side adjusters
- Fully adjustable

Order Code: **PROMXB08**



## Knee & Elbow Protectors

- Knee Protectors: Shock absorbent plastic knee and shin panels
- Elbow Protectors: Shock absorbent plastic elbow and forearm panels

Both feature textile carcass with velcro fasteners.

Order Code Description  
**PROMXK01** Knee protectors  
**PROMXE01** Elbow protectors



## Neck Brace

- Provides neck support for increased comfort and safety
- Universal adult size
- Velcro rip-stop closure
- Removeable washable sleeve

Order Code: **PROMXN01**



## Adult Boots

A fantastic quality entry level adult off-road boot, perfect for MX bikes, ATV's and Quads.

- Leather upper
- Protective toe shell
- Rubber cleated sole
- Kwik-Klik buckles and velcro fastening

Order Code	UK Size	Euro Size
<b>BOTMXC06</b>	6	41
<b>BOTMXC07</b>	7	42
<b>BOTMXC08</b>	8	43
<b>BOTMXC09</b>	9	44
<b>BOTMXC10</b>	10	45
<b>BOTMXC11</b>	11	46



## Race Socks

- Ultra comfort knee length sock, specifically designed for use with motorcycle boot wear
- Loop knit for comfort
- Maximum cushioning & support
- Fitted ankle to minimise slippage

Adult One Size Fits All  
 Order Code: **SOCMX01**

### Youth Sizes

Order Code	Shoe Size
<b>SOCMX03</b>	12.5 - 3 (32-35)
<b>SOCMX05</b>	4-6 (36-41)



## Coolmax Helmet Liner

Coolmax material utilises a four-channel fibre that draws moisture to the outer surface, where it is quickly evaporated. This proven moisture management material wicks sweat away from the body and allows air to pass through, keeping the user drier and more comfortable. Adult freesize.

Order Code:  
**BALHEL**



## Neck Tube

A selection of thermal neck tubes for motorcyclist use, ensuring warmth and wind protection whilst riding. Choose from original poly-cotton and new heavy-weight thermal.

Order Code	Colour
<b>NTUBLK</b>	Black poly-cotton
<b>NTUR</b>	Red poly-cotton
<b>NTUBU</b>	Blue poly-cotton
<b>NTUTH</b>	Black heavy-weight



NTUBLK



NTUTH



**Youth Helmets**

- Lightweight aerodynamic alloy shell
- Padded Double D retention system
- GP graphics
- Goggle grabbers
- ECE 22-05
- ACU approved
- Air channel ventilation system
- Adjustable visor
- Complete with helmet bag

**BLACK**

- Order Code Size
- HEL70KS** Small
- HEL70KM** Medium
- HEL70KV** Replacement Visor



**BLUE**

- Order Code Size
- HEL72KS** Small
- HEL72KM** Medium
- HEL72KV** Replacement Visor



**RED**

- Order Code Size
- HEL74KS** Small
- HEL74KM** Medium
- HEL74KV** Replacement Visor

**GREEN**

- Order Code Size
- HEL78KS** Small
- HEL78KM** Medium
- HEL78KV** Replacement Visor



**ORANGE**

- Order Code Size
- HEL79KS** Small
- HEL79KM** Medium
- HEL79KV** Replacement Visor



Helmet Size Chart

KIDS	
S	M
49-50cm	51-52cm

**WSGG Youth Goggles**

- Off-road competition goggle
- Reduced shape with wide peripheral vision
- Durable and flexible polyurethane frame
- Contoured fit single foam padding
- Scratch resistant anti-fogging lens
- Inbuilt frame vents



- Order Code Colour
- GOGKIDBK** Black
- GOGKIDBU** Blue
- GOGKIDR** Red

**REPLACEMENT LENSES**

Replacement polycarbonate lenses for WSGG youth goggles. Scratch-resistant and anti-fogging.



- Order Code Colour Pack Qty
- LENKIDC** Clear 2
- LENKIDS** Smoked 1

**TEAR-OFFS**

10pc tear-off pack for youth goggles



Order Code: **GOGTOFKID**

Keep goggles clean with tear-offs for youth models. Each pack contains 2 self-adhesive fixing stems, plus 10pcs of clear tear-off film. Stems simply stick to the outside of the goggle lens, the tear-off films clipping onto the stems. Suitable for use on all youth WSGG goggles and lenses.

## Youth Short-sleeved Jacket Protector

Jacket protectors offer optimum upper torso protection and comfort for off road riding in one complete product.

This new model offers equivalent levels of protection for those riders who prefer to have their lower arms free

### Features:

- Breathable mesh inner jacket with front zip
- Vented hardshell protectors on front torso and shoulders
- Impact-absorbent foam padding
- Removable back protector with interlocked hardshell panels
- Integral adjustable kidney belt
- EN approved

Order Code    Size  
**PROMXJ22**    Youth XS / Small  
**PROMXJ24**    Youth M / L



## Youth Jacket Protector

- Lightweight breathable mesh inner jacket with zip front
- EVA foam with injection moulded hardshell PP protectors
- Protectors on front torso, shoulders, upper arm, elbow and lower arm
- Removeable back protector with EVA foam and interlocked moulded PP protectors
- Integrated kidney belt
- Adjustable velcro closures
- CE approved



Order Code    Size            Approx Age  
**PROMXJ08**    XS / Small        >8 years  
**PROMXJ10**    Medium / Large    9 years>



## Youth Body Armour

Advanced premium range of upper-body armour, in sizes for juniors and kids. Each set features chest, back, shoulder and upper arm protection, with velcro and buckle closures. EVA edge-lined for comfort fit and added protection.



- Made from ergonomically shaped polypropylene
- Vented for optimum airflow
- EVA edge-lined and inner panelled
- Nylon webbed floating shoulders
- Quick-Fit buckle closures
- Black body, silver shoulders, black arms

Order Code    Size            Approx Age  
**PROMX06**    Junior         9 years>  
**PROMX07**    Mini            >8 years

Colours subject to change



## Youth Body Belt

Universal Moto-X kidney belt for children.

- Neoprene construction
- Reinforced back panel with high density internal reinforcements
- Adjustable straps
- 22-27" waist

Order Code:  
**PROMXB02**



## Youth Neck Brace

- Provides neck support for increased comfort and safety
- Universal youth size
- Velcro rip-stop closure
- Removeable washable sleeve

Order Code:  
**PROMXN03**



## Youth Knee & Elbow Protection Pack

Includes one pair of elbow guards and one pair of knee/shin guards

Textile bodied guards with hard shell protectors on elbow/forearm and knee/shin. Guards secure by two Velcro adjustable straps.

Order Code: **PROMXS01**





## Youth V-Flex Gloves

- Premium youth race glove
- Unique dual split-upper construction for flexibility
- Lever-gripper inlays on index and middle digits
- Breathable mesh construction
- GP-PRO logo protector pads on upper and fingers
- Reinforced padded thumb and palm sections
- Stretch neoprene cuff with velcro closure

### BLUE

Order Code	Size
GLVMX04BUXS	XS
GLVMX04BU2XS	XXS
GLVMX04BU3XS	XXXS

### GREEN

Order Code	Size
GLVMX04GNXS	XS
GLVMX04GN2XS	XXS
GLVMX04GN3XS	XXXS

### ORANGE

Order Code	Size
GLVMX04ORXS	XS
GLVMX04OR2XS	XXS
GLVMX04OR3XS	XXXS

### BLACK

Order Code	Size
GLVMX04BKXS	XS
GLVMX04BK2XS	XXS
GLVMX04BK3XS	XXXS

### RED

Order Code	Size
GLVMX04RXS	XS
GLVMX04R2XS	XXS
GLVMX04R3XS	XXXS

### YOUTH GLOVES SIZES

XXXS	XXS	XS
10-12cm	13-14cm	15-16cm
5	6	7



## Youth Neo Flex 2 Gloves

- Stretch neoprene cuff and knuckle
- Breathable mesh construction
- Reinforced thumb, palm and inset
- Padded protective GP-PRO logo panelling on upper and fingers
- Velcro cuff closure

### BLUE

Order Code	Size
GLVMX06BUXS	XS
GLVMX06BU2XS	XXS
GLVMX06BU3XS	XXXS

### GREEN

Order Code	Size
GLVMX06GNXS	XS
GLVMX06GN2XS	XXS
GLVMX06GN3XS	XXXS

### ORANGE

Order Code	Size
GLVMX06ORXS	XS
GLVMX06OR2XS	XXS
GLVMX06OR3XS	XXXS

### BLACK

Order Code	Size
GLVMX06BKXS	XS
GLVMX06BK2XS	XXS
GLVMX06BK3XS	XXXS

### RED

Order Code	Size
GLVMX06RXS	XS
GLVMX06R2XS	XXS
GLVMX06R3XS	XXXS

### YOUTH GLOVES SIZES

XXXS	XXS	XS
10-12cm	13-14cm	15-16cm
5	6	7



## Youth Vanguard Gloves

- Air mesh and honeycomb fabric uppers
- Rubberised protective logo panelling
- Reinforced thumb, palm and inset
- Velcro cuff closure

### BLUE

Order Code	Size
GLVVANBUXS	XS
GLVVANBUXXS	XXS
GLVVANBUXXXS	XXXS

### RED

Order Code	Size
GLVVANRXS	XS
GLVVANRXXS	XXS
GLVVANRXXXS	XXXS

### BLACK

Order Code	Size
GLVVANGYXS	XS
GLVVANGYXXS	XXS
GLVVANGYXXXS	XXXS

### YOUTH GLOVES SIZES

XXXS	XXS	XS
10-12cm	13-14cm	15-16cm
5	6	7



## Exhaust Wrap

Exhaust and header pipe high-temperature tape, requires no wetting to fit. Highly durable and thermal shielding, the material is constructed from fibres extruded from pulverised lava rock. The wrap handles direct continuous heat over 700 degrees C, helping reduce heat transfer from exhaust systems. Supplied with stainless steel ties for fitting. 1" width, 50ft roll.

**NEW**

Order Code: **STKHRT04**



## Adhesive Heat Shield Sheet

Self-adhesive heat shield for bodywork protection from engine and exhaust heat. Supplied as a 50x50cm sheet, the shield can be precisely cut to the required shape and size for use on fairings and panels. Flexi aluminium top section, fibreglass inner with ultra-sticky adhesive backing.

**NEW**

Order Code: **STKHRT02**



## 'Cut Your Own' Tank Pads

45x33cm adhesive protector sheet. Protects road bike tanks, bodywork and framework from abrasion. Use on off-road bikes as panel backgrounds. Cut to required shape and size.

Order Code	Colour
<b>STKBAK02</b>	Transparent
<b>STKBAK04</b>	Carbon Effect
<b>STKBAK06</b>	Black
<b>STKBAK08</b>	White
<b>STKBAK10</b>	Red
<b>STKBAK12</b>	Yellow

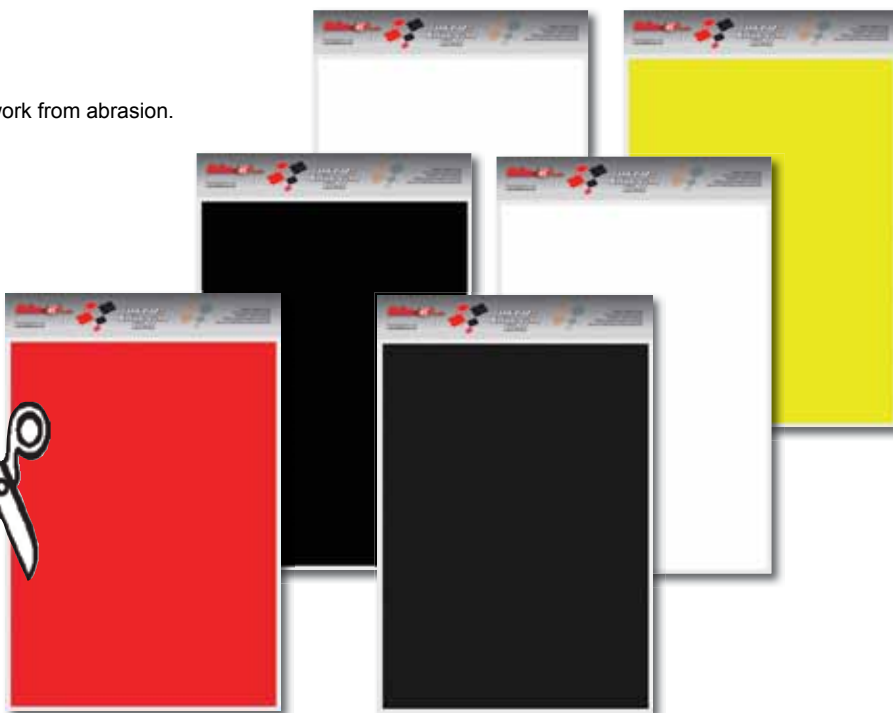

## Racing Numbers

Self adhesive race numbers for use on fairings, cowls and number boards.

Available in 6 & 8" size in Blue (**BU**), White (**W**) and Black (**B**) colour. Sold as packs of 10pcs of single number.

To order numbers, use Order Code: **STK**, followed by the size (**6** or **8**) then colour (Blue, Black or White), then number required (**0-9**). eg. **STK8W9** = Pack of 8" White in number 9.



## Gripper Tank Pads

Tank pad protector sheets with feature raised nodules, increases grip against petrol tank. Specially designed shape to optimally fit all tanks.

Order Code	Colour
<b>TPPRT08</b>	Transparent
<b>TPPRT10</b>	Black

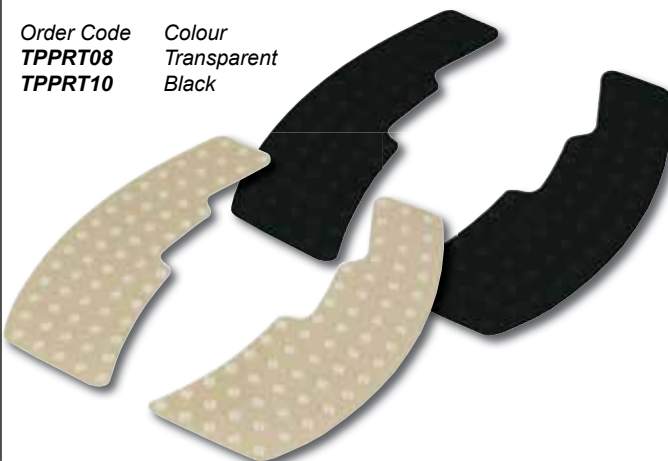



**Adjustable Fork Oil Seal Driver**

Universal tool to safely and simply install fork oil seals into forks, without causing damage to the new oil seals or fork stanchions. Adjustable from 39 – 50mm

Order Code: **TLSFRK11**

**NEW**



**Bearing Packer**

Compact unit which connects to grease gun (not supplied) and injects grease into bearing units, completing the job quickly and cleanly. Suitable for bearing diameters 50-95mm. Complete with dust cover for clean storage after use.

Order Code: **TLSBEA02**

**NEW**



**Brake Caliper Piston Tool**

Specific handtool for holding and detaching brake pistons, grabs brake caliper pistons internally enabling seized pistons to be worked free.

Order Code: **TLSHOL49**



**Steering Head Cup Remover**

Steering head cup tool ensures accurate and simple steering head bearing race/cup removal. The flared end-section locates on the internal lip of the race/cup, the opposite end is then hammered to remove the race/cup.

Order Code	Description
<b>TLSRMV02</b>	28-32mm
<b>TLSRMV04</b>	38-55mm

**NEW**



**Universal Shock Wrench**

Order Code	Size
<b>SHKWRE</b>	69-76mm & 89-96mm
<b>SHKWRE01</b>	38-45mm & 45-52mm



**Graduated Workshop Syringe**

60ml graduated workshop syringe. Many applications such as brake bleeding and fork oil adjustment.

Order Code: **TLSSYR11**



**Fork Oil Level Adjuster**

Features level adjuster mounted on filler probe and graduated syringe. Makes easy work of precision fork oil adjustment.

Order Code: **TLSFRK07**

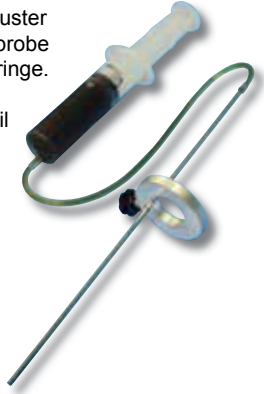

## Tool Boxes

Durable plastic tool boxes with tough closure clasp and carry handle. Each includes a removable inner shelf and external top storage for tools and small parts.

**NEW**

Order code    Size  
**TLSCAB09**    15litre (43x18x20cm)  
**TLSCAB11**    4.5litre (29x13x12cm)



TLSCAB09



TLSCAB11

## Flywheel & Clutch Pulley Holder

This adjustable pulley holder is suitable for flywheel and clutch pulleys. Adjustable from 70-125mm with lockable adjuster bolt. Non-slip coated handle for safety and comfort.

Order Code: **TLSHOL07**



## Deluxe 4pc Pick Set

Set of 4 hook and pick tools for variety of intricate applications such as removal of oil seals, O-rings, pull springs and cotter pins, making punch holes. Features selection of sharp ends and contour handles.

**NEW**

Order Code: **TLSPIC13**



## Oil Seal Puller

Dual hooked-tip tool allows removal of hard-to-reach seals without damaging housing or bearings.

**NEW**

Order Code: **TLSPUL13**



## Precision Scrapers

3pc set of scraping tools with various shape and size heads, makes quick and accurate work of gasket removal and preparation, adhesive and dirt removal etc.

Order Code: **TLSKNF03**



## Combination Wrench Set

Premium quality 17pc metric chrome vanadium combination wrench set. Each wrench is precision manufactured to DIN 3113 specification, featuring one open and one offset ring end. Supplied in storage tray designed for tool chest shelving. Includes ones of each wrench size 6-22mm.

Order Code: **TLSET16**

**NEW**



## Tool Chest & Cabinet

Mechanics steel combination tool chest and cabinet set.

Lower unit features two drawers and large capacity storage compartment with up-and-over door. Tool chest features multiple lockable drawers plus lid.

Tool chest can be placed in storage compartment. Width 616mm x depth 330mm x height 1070mm

Order Code: **TLSCAB03**



## Mobile Workstation

Steel mobile workstation and tool storage unit. Features lower shelf for open storage of tools and cleaning products. Two storage shelves set on smooth ball-bearing mechanism. Top work surface has durable inlay for grip and protection, the surface slides outwards to expose lockable internal storage compartment. Mounted on sturdy 1" casters with brakes for easy movement. Assembled size 705x370x830mm

Order Code: **TLSCAB05**

**NEW**



## Folding Kit Cart

- Versatile folding trolley for storing and moving motorcycle kit and tools
- 35kg load capacity
- Lightweight collapsible design, for easy storage
- Telescopic aluminium handle
- Expanded dimension 42 x 40.5 x 33cm
- Folded dimension 42 x 40.5 x 8cm
- Rubberised wheels

Order Code: **TLSCRT35**





### Deluxe T-Bar Socket Spanners

Superior T-Bars with rubber grip handles, and wrench contact points.

Order Code	Size
TBS08	8 mm
TBS10	10 mm
TBS11	11 mm
TBS12	12 mm
TBS13	13 mm
TBS14	14 mm
TBS17	17 mm
TBS19	19 mm

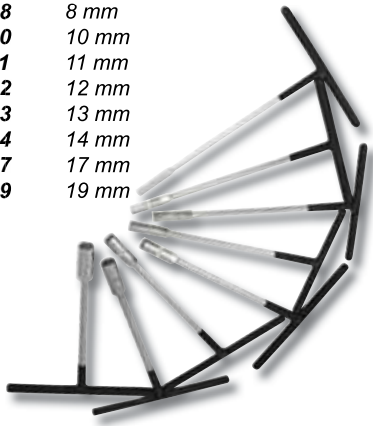

**8pc WORKSHOP PACK**  
Contains one of each size  
Order Code: **TBSSET**

### T-Bar Socket Spanners

Order Code	Size
TSP08	8 mm
TSP10	10 mm
TSP11	11 mm
TSP12	12 mm
TSP13	13 mm
TSP14	14 mm
TSP17	17 mm
TSP19	19 mm



**8pc WORKSHOP PACK**  
Contains one of each size  
Order Code: **TSPSET**

### Y-Bar Sockets

Strong Y-bars with three different sized sockets, for efficient and quick tool selection and use.

**NEW**

Order Code	Sizes
YSP08	8, 10, 12mm
YSP02	9, 11, 13mm
YSP04	12, 14, 17mm
YSP06	14, 17, 19mm



### Spring Hook

16cm reach spring hook tool  
Order Code: **HOOKSPR**



### Safety Lock Wire Tool

Safety Lock Wire and tool. Ensures parts stay on vehicle. Quickly and neatly twists wire. A must for high vibration locations.

**NEW**

Order Code: **TLSWPL12**

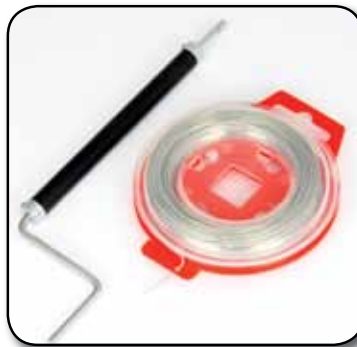

### Lock Wire Dispenser

30m length of locking wire supplied in hand cassette dispenser.

**NEW**

Order Code: **TLSWPL14**



### Safety Lockwire Washers

18pc pack of safety lock wire washers, contains M6, M8 and M10 thread sizes. Install under bolt head and fold the tab upwards, enables multiple washers to be connected by safety lock wire.

**NEW**

Order Code: **BOLWSH13**



### Cable Lubricators

Order Code	Colour
CLBBU	Blue
CLBBLK	Black & Gold
CLBDUO	Dual Cable Oiler



### Magnetic Parts Dish

Strong magnetic parts dish keeps bolts, screws, washers etc\*. secure, not on the floor!

Order Code: **TLSMAG01**



\* Contents not included. Colours may vary.

### Wire Pliers & Lock Wire

Order Code:	Description
TLSWPLIER	9" safety lock wire pliers
GRPWIRE	Stainless steel lock wire for use with wire pliers, ideal to secure grips etc. 0.7mm x 30m
GRPW500	Lock wire reel - 0.8mm x approx 127m (500g)



### Emergency Cable Repair Kit

Emergency repair kit for temporary fixing of cables, includes 2 different coils of cable and selection of clamps, supplied in aluminium storage tin.

Order Code: **CRK009**



### Foam Kneeling Pad

Durable foam kneeling pads, protects knees from floor whilst working around motorcycles.

Order Code: **FOAMPAD01**

**NEW**



### Tirox 360 Chain Brush

Fast, easy and precise chain cleaning device. This chain brush simply twists around drive-chain, the bristles completely surrounding and contacting with chain, ensuring optimum 360 degree cleaning. Suitable for use with all chain sizes (415-630), O-Ring and X-Ring safe.

Order Code: **CHBBSH06**



### Chain Brush

Dual headed chain brush for easy agitation of dirt. Suitable for use with chain cleaners.

Order Code: **CHBBSH02**

#### REPLACEMENT BRUSH BLADES

Order Code: **CHBBSH04**



Colour may vary

### Chain Spring-Link Pliers

Off-set ended pliers enable easy fitment and removal of chain spring-links. The shorter lip engages the chain pin, whilst the longer lip engages the retaining clip.

**NEW**

Order Code: **TLSPLI07**



### Deluxe Allen Keys

9pc extra long ball end hex key set (1.5, 2, 2.5, 3, 4, 5, 6, 8 & 10mm)

Order Code: **ALLBALL**



### Chain Breakers

- | Order Code     | Description  |
|----------------|--|
| <b>CHBHD</b>   | Heavy duty type chain breaker, for all chain sizes |
| <b>CHBHDP</b>  | Pin for CHBHD                                      |
| <b>CHBSTD</b>  | Standard type chain breaker                        |
| <b>CHBHDCH</b> | Deluxe heavy duty chain breaker, with spare pin    |



### Chain Cutter & Riveter

- | Order Code:      | Description   |
|------------------|---|
| <b>CHBKIT</b>    | Heavy duty chain cutter and riveter<br>Fits all drive chains.                   |
| <b>CHBKITPIN</b> | Heavy duty chain tool kit replacement pins 2.2mm, 2.9mm, 3.8mm, & riveter 5.5mm |



### Chain Cleaning Kit

This kit features a cassette housing which clamps around drive chain, internal brushes clean debris and dirt from the chain as it is pulled through. Chain cleaner can be fed into the cassette from the top feed tube, dirty cleaner exiting from the drain tube. Includes cord and hooks enabling attachment to bike whilst in use, and plastic drainage/cleaner bottle.

- | Order Code      | Description         |
|-----------------|---------------------|
| <b>CHBCLE06</b> | Chain Cleaning Kit  |
| <b>CHBCLE08</b> | Replacement brushes |



### Chain Alignment Tool

Simple-use tool enables rear sprocket to be correctly aligned with chain. Helps prevent chain and sprocket wear.

Order Code: **CHBALG10**

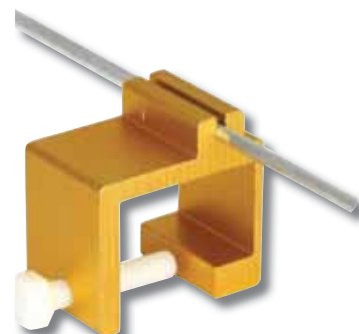



### Deluxe Tyre Levers

Extended handle-length tyre levers for additional leverage and ease of use.

Order Code	Size
TYL014	14"
TYL017	17"

**NEW**

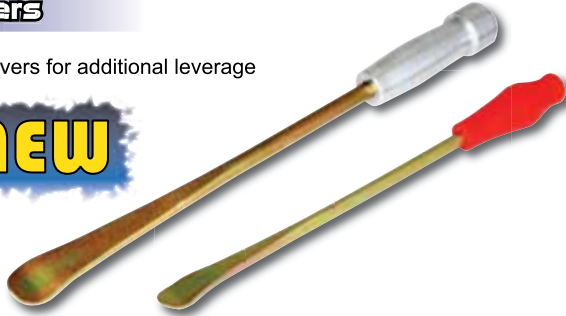

### Spoke Wrench

6-way spoke wrench, 1-6.  
Order Code: **SPOWRE6**



### Spoke Wrench Set

2 piece spoke wrench set (8,9,10,11)  
Order Code: **SPOWRE**



### Tyre Paste

Make tyre fitting easy with use of this bead lubricant. Available in 1kg and 5kg tubs.

Order Code	Size
REP020	1kg
REP025	5kg

**NEW**



### Steel Tyre Valve Puller With Rubber Protector

Valve puller tool with rubber protector for safely pulling long or short valves into rims without damaging the valve or rim.  
Order Code: **VLVINS**

**NEW**



### Valve Tool

4 Way valve removal tool  
Order Code: **VLVTOOL**

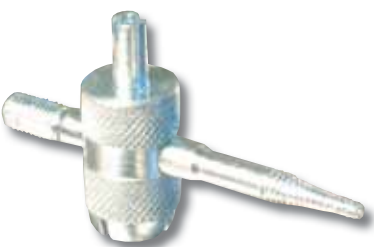

### Air Valve Puller

Simplifies inner tube and tyre fitment, attaches to the valve enabling it to be pulled through the valve hole in wheel rim.

**NEW**



Order Code: **VLVPUL**

### Tyre Levers

Order Code	Description
TYLR	Round type
TYLF	Flat type
TYLH	Handled deluxe type

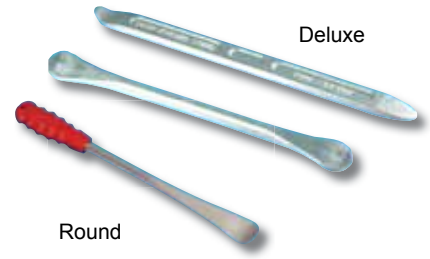

### Tyre Fitting Tool

Eases tyre fitment by positioning tyre, allowing fitter to mount opposite bead.



Order Code: **TYLCLP**

### Spark & Spoke Wrench

Multi-function tool with 13mm/16mm spark plug spanner head, with opposite end featuring 3 size spoke key.



Order Code: **SPOWRE9**

### Rim Protectors

Rim protector for tyre changing (2 pcs) with connecting cord.  
Order Code: **RIMPROT**



### Tyre Crush Tool

Long handled tool offers great leverage for tyre removal, forcing tyre beads off the rim.

Order Code: **TYC012**



### Magnetic Spark Plug Sockets

Order Code Description  
**SPKSOC16** 16mm socket 3/8"  
**SPKSOC18** 18mm socket 3/8"  
**SPKSOC206** 20.6mm socket 3/8"



### Ignition Spark Plug Tester

Tests for HT spark potential

Order Code: **SPKTEST**



### 26pc Feeler Gauge Set

Metric and Imperial measurements.

Order Code: **SPKGAU**



### Spark Plug Set

5pc spark plug maintenance set including brush and feeler gauge.

Order Code: **SPKSET**



### Deep Reach Plug Wrench

Deep reach plug wrench 15cm reach

Order Code: **WNC10**



### Spark Plug Gauge

Coin type spark plug gauge

Order Code: **SPKCOIN**



### Plug Holder

Waterproof canister for spare spark plug (Spark plug not included)

Order Code: **PLUGHOLD**

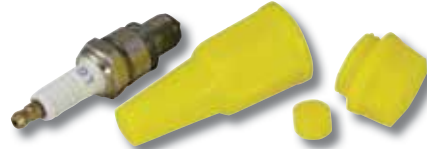

### Axle Bolt Punch

Strong bolt punch specific for tapping out axle bolts.

**NEW**

Order Code: **TLSAXL13**



### Oil Filter Removal Screw

Strong handled shaft with screw thread end, for removal of air filter canisters.

**NEW**

Order Code: **OFWSCR**



### Rear Axle Nut Spanner

Order Code Description  
**TLSAXD04** 36mm offset rear axle nut spanner  
**TLSAXD10** 32mm straight rear axle nut spanner



### Low Pressure Gauge

1-20 PSI range gauge. Perfect for off-road and trials.

Order Code: **TGULOW**



### Jumbo Barrel Foot Pump

Vertical barrelled foot pump with folding foot-stand.

Measures up to 100 PSI / 7.0 BAR. Over-sized dial for ease of use. Schraeder and Presta valve fitment. Valve adaptor storage compartment.

Order Code: **PMP007**



### Tyre/Bead Breaker

Portable tyre and bead breaker, suitable for all wheel and tyre sizes from 16".

Order Code: **TYC008**





### Mains-Water Power Washer

A mains-water fed power washer which runs independently of mains-electricity. Ensures safe and efficient washing of motorcycles and vehicles. Simply attaches to standard fitment garden-hose (not supplied)

- 1900 P.S.I / 130 Bar
- Interchangeable nozzles for spray options
- 8 Litre/min flow rate
- Efficient 4 stroke generator
- Robust wash lance
- 8m high-pressure wash hose
- Steel tube frame with tube-type tyres

Order Code: **WSH003**

**NO MAINS ELECTRICITY REQUIRED**



### Remote Power Washer

A superbly powerful washer which runs independently of mains electricity and mains water. This unique function enables it to be used remotely at MX events and tracks.

- 2200 P.S.I / 154 Bar
- Interchangeable nozzles for spray options
- 7.5 Litre/min flow rate (2.0 gallons / min)
- Efficient 4 stroke generator
- Robust wash lance
- 8m high-pressure wash hose
- Steel tube frame with tube-type tyres
- Water-feed hose with immersible filter

**Do not confuse this item with other versions commonly available that need mains water and electricity supply.**

Order Code: **WSH004**



**NO MAINS ELECTRICITY REQUIRED OR MAINS WATER**

### 3pc Workshop Brush Kit

Set of three workshop brushes for effective cleaning and maintenance of motorcycle engine and frame parts. Includes one nylon bristle and two metal bristles brushes.

**NEW**

Order Code: **CLE050**



### Bristle & Foam Brush

Double action brush featuring rough foam and nylon bristle sections. Suitable for both general and wheel cleaning. Contoured easy-grip handle.

Order Code: **CLE034**



### Claw Bristle Brush

Nylon bristle brush featuring open-end enabling all-round cleaning of wheels, forks, swinging arms etc. Contoured easy-grip handle.

Order Code: **CLE036**



### Wheel Brush

Tapered nylon bristle brush suitable for both general and wheel cleaning. Contoured easy-grip handle.

Order Code: **CLE038**



### Detail Brush

Double bristled nylon brush suitable for both general and wheel cleaning. Contoured easy-grip handle.

Order Code: **CLE002**



### Brake Bleeding Assistor Kit

Brake bleeding assistor kit utilises a compact unit with one-way valve and connector hoses that simply attach onto the bleed nipple. When the nipple is open and brakes bled, the unit prevents air and old fluid from being pulled back into the system, freeing the user from having to repeatedly open and close the bleed nipple.

Order Code: **BRKKIT01**



### Brake Bleeder/Vacuum Pump

Comprehensive workshop vacuum pump kit. Includes reservoir and nipple adaptor for brake bleeding. The hand operated pump pulls the fluid through the bleed nipple, eliminating need to use the brake lever or pedal. Manual pump with pressure gauge allows testing of many vacuum operated systems, eg fuel pumps, carbs, etc.

Order Code: **BRKKIT07**



### Fuel Jug

5 litre fuel jug with lid and flex spout.

Order Code	Description
SYP007	Fuel jug
SYP009	Replacement spout.



### Oil Funnel

Metal oil funnel with flex pipe  
Order Code: SYP005



### Auxiliary Fuel Tank

- For use when tuning with fuel tank off bike
- Temporarily replaces fuel tank while synchronizing carbs
- Includes fuel line and in-line petcock
- Graduated fuel tank with hanging hook for gravity feed.

Order Code:  
AUX008

Close up  
of in-line  
petcock



Replacement in-line  
petcock  
Order Code:  
AUX008P



### Fuel Syphon

Hand-pump syphon, simple and efficient for transfer of fuels and liquids. Use for transferring fuel or for tank draining.  
Order Code: SYP001



### Fuel Funnel

2 pc plastic fuel funnel (funnel & extension pipe)

- Removable flexible stem
- Handle
- Gauze filter

Order Code:  
SYP003



### Fuel Jerry Cans

Heavy duty fuel storage cans in 20 litre and 10 litre options. Feature robust carry handle and safety locking cap. Extra safe pouring nozzle available separately.

Order Code	Size
JRC20L	20 litre
JRC10L	10 litre

#### POURING NOZZLE

Order Code: JRCPOU



### 10 Litre Oil Pan

10ltr oil drain pan featuring front and rear hand-grabs, directional spout, rolled edges to prevent spillage.

Order Code: OILPAN10



### 8 Litre Oil Pan

- 8ltr Oil Drain Pan - easy and efficient collection and disposal of engine oil/fluids.
- Non-spill pouring spout.
- Oil filter drain ledge.
- Easy grip rim.

Order Code: OILPAN



### Oil Drain Can

Collected oil is sealed inside can, carry handle and stoppers allow can to be removed and drained cleanly without spillage.  
6ltr Oil Drain Can  
Easy and efficient collection and disposal of oil.

Order Code: OILCAN6



### Fuel Measuring & Mixing

Order Code	Description
GTD001	Graduated measuring cylinder 250ml
GTD002	Graduated measuring bottle with stopper & cap 250ml
GTD003	Graduated measuring jug with handle 500ml
GTD004	Graduated measuring jug with handle 1000ml



GTD003



GTD002



GTD004



GTD001



## Tiedown Straps

A selection of tiedown straps for safely securing vehicles in transit and storage, available in varying webbing sizes, ratchet and auto-lock combinations.

Order Code	Qty	Type	Colour	Breaking Strength	Hook
TIE2AUTO	2	Autolock 1.8m x 25mm	Red	400kgs	S
TIE4AUTO	4	Autolock 1.8m x 25mm	Red	400kgs	S
TIE2RAT	2	Ratchet 5m x 25mm	Blue	500kgs	S
TIE4RAT	4	Ratchet 5m x 25mm	Blue	500kgs	S
TIERATPRO	1	Ratchet Pro 2.4m x 50mm	Red	1375kgs	Claw
TIERAT08	2	Ratchet Jumbo 3m x 30mm	Green	1375kgs	Claw



TIERATPRO



TIERAT08



TIE2RAT



TIE2AUTO



## Bar Support Straps

Nylon webbing strap with grip cuffs. Fits across handlebars to provide anchor points for tie-down straps to secure bike in transit.

Order Code: **TIEBAR**



Stabilises bikes in transit

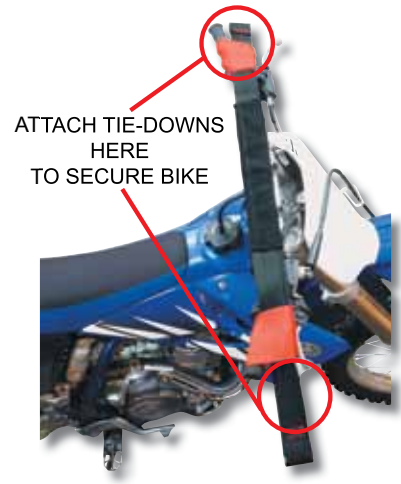

ATTACH TIE-DOWNS HERE TO SECURE BIKE

## Fork Supports

Fork supports for use when transporting bikes, prevents over compression of forks when using tiedowns. Available in two sizes.

- Order Code Type
- FKV031S Standard size, 28cm+ travel
  - FKV031M Mini size, 19.5cm->27.5cm travel



## Micro Tiedown Straps

TUV approved micro webbing strap with auto-lock mechanism. Ideal for additional strapping of motorcycles and vehicles in transit and storage.

- 25mm wide, 2.5m long
- 200kgs capacity
- Supplied in pairs

Order Code: **TIE2MIC**



## Tiedown Shrouds

Protect fairings and bodywork from abrasion when using tie-downs. Bespoke neoprene sleeves wrap and fasten around the tie-down webbing strap. The shrouds can then be adjusted along the tie-down to contact points between bike and webbing. Supplied in pairs. Available for 25, 30 and 50mm width straps.

- Order Code Width
- TIE2SHR 25mm
  - TIE2SRA 30mm
  - TIE2SRB 50mm

**NEW**



### Chain Cleaner

- Biodegradable
- Breaks down grime, oil and grease
- Suitable for all chain types including O and X-ring
- 500ml

Order Code: **CLE020**



### Chain Lube

- Synthetic clear, dry non stick lubricant
- PTFE based, withstands all weathers
- Performs in high temperature and wear conditions
- 500ml

Order Code: **CLE022**



### Silicone Care Spray

- Silicone based fast acting dressing and lubricant
- Protects, lubricates and renovates plastic, rubber, metal and other surfaces
- Leaves treated area with a sheen finish
- 500ml

Order Code: **CLE028**



### Brake Disc Cleaner

- Quickly breaks down oil, dirt and grime
- Quick drying formula
- Useable on clutch plates and housings
- Useable as a contact cleaner
- 500ml

Order Code: **CLE026**



### Degreaser

- Biodegradable
- Foaming formulation for increased dwell time
- Breaks down grime, oil and grease
- 500ml

Order Code: **CLE024**



### MW40 Penetrating Spray

- Multi-purpose lubricant and penetrating fluid
- Frees and lubricates seized mechanisms and components
- Displaces water, protects electrics
- Quickly penetrates through oxides and soiling
- Leaves a lubricating protective film on treated areas
- 500ml

Order Code: **CLE030**



### Mechanic Glove - Open Finger

Lightweight and comfortable mechanic glove, featuring three open-ended, fingers for increased sensitivity when handling smaller components.

Extended cuff with velcro closure.

Reinforced palms.

Flatlock stitching on open fingers.

Offers hand protection during workshop tasks.

**NEW**

Order Code	Size
GLVMEC10S	Small
GLVMEC10M	Medium
GLVMEC10L	Large
GLVMEC10XL	XL



### Mechanic Glove - Full Finger

Lightweight and comfortable mechanic glove.

Extended cuff with velcro closure.

Reinforced palms.

Offers hand protection during workshop tasks.

**NEW**

Order Code	Size
GLVMEC12S	Small
GLVMEC12M	Medium
GLVMEC12L	Large
GLVMEC12XL	XL



### Latex Gloves

Dermatologically friendly  
Prevents Infection

Order Code Description

GLVLM	Medium latex gloves (Box of 100)
GLVLT	Large latex gloves (Box of 100)
GLVLTXL	XL latex gloves (Box of 100)



### Sure Grip Mechanic Gloves

'Sure Grip' Mechanics Glove with rubber palm and finger grips. Offers protection to hand and increases grip. Great for handling tyres  
1 Size Fits All

Order Code: **GLVMEC02**





**KTM/Euro MX Hardware Mini Kit**

This 50pcs kit includes the perfect assortment of metric bolts, nuts, cotter pins, washers and specific hardware for KTM/Euro off-road and MX bikes. **NEW**

Order Code: **BOLKIT15**



**Japanese MX Hardware Mini Kit**

This 50pcs kit includes the perfect assortment of factory sized metric bolts, nuts, cotter pins, washers and specific hardware for Honda, Kawasaki, Suzuki and Yamaha off-road and MX bikes. **NEW**

Order Code: **BOLKIT12**



**ATV / Quad Hardware Kit**

This 188pcs kit includes the perfect assortment of factory sized flange/allen/button bolts, nuts, screws, cotter pins and specific hardware for Honda, Kawasaki, Suzuki and Yamaha ATVs. **NEW**

Order Code: **BOLKIT06**



**KTM/Euro MX Hardware Kit**

This 158pcs kit includes the perfect assortment of metric bolts, nuts, cotter pins, washers and specific hardware for KTM/Euro off-road and MX bikes. **NEW**

Order Code: **BOLKIT03**



**Japanese MX Hardware Kit**

This 170pcs kit includes the perfect assortment of factory sized metric bolts, nuts, cotter pins, washers and specific hardware for Honda, Kawasaki, Suzuki and Yamaha off-road and MX bikes. **NEW**

Order code: **BOLKIT09**



**Compartment Store**

Plastic storage compartment 205mm (W)x 100mm (L) x 27mm (D). 6 internal compartments with 2 removable dividers to make 6, 12 or 18 compartment combinations. Hinged securing lid. Perfect for storing bolts, washers, nuts, fuses etc.

Order Code: **TLSCOMP**



Contents not included

**150pc R-Clip Assortment**

A complete collection of replacement R-Clips in six sizes included in a plastic storage case. Order Code: **ASST09**



**500pc Cotter Pin Assortment**

A wide selection of pins for all securing needs. Complete with a storage case. Order Code: **ASST12**



**100pc Nylon Locknut Assortment**

Nylon insert works as a lock washer to keep fasteners secure in high-vibration applications. Zinc-plated to resist corrosion. Selection of 6, 8, 10, 12mm in a plastic storage case. Order Code: **ASST06**



### 141pc Rubber Washer Assortment

Selection of rubber and fibre washers in a storage case.  
Order Code: **ASST03**



### Duct Tape

50mm x 50m  
Order Code    Colour  
**DCTBLK**      Black  
**DCTSIL**      Silver



### Insulation Tape

Pack of 10 rolls  
Order Code    Colour  
**INTBLK**      Black  
**INTR**          Red  
**INTBU**      Blue  
**INTYE**      Yellow



### Sprocket Bolt Kit

6pc sprocket bolt and nut kit.  
Chrome Moly (CRMO) M8\*25mm bolts (1.25 pitch).  
Countersunk allen head.  
Nylon-locking carbon steel nuts.

Order Code: **SPNKIT11**



### Brake Rotor Bolts

High quality 10.9 grade steel replacement brake rotor bolt kits.

**NEW**

Order Code	Description
<b>BOLRTR03</b>	Honda Front Bolts/Nuts M6x19mm (6pcs)
<b>BOLRTR06</b>	Honda Rear Bolts/Nuts M6x19mm (4pcs)
<b>BOLRTR12</b>	Kawasaki Front Bolts M6x13mm (4pcs)
<b>BOLRTR15</b>	Kawasaki Rear Bolts M8x15mm (4pcs)
<b>BOLRTR09</b>	KTM Bolts Front / Rear M6x13mm (6pcs)
<b>BOLRTR12</b>	Suzuki Front Bolts M6x13mm (4pcs)
<b>BOLRTR15</b>	Suzuki Rear Bolts M8x15mm (4pcs)
<b>BOLRTR18</b>	Yamaha Front Countersunk M6x12mm (6pcs)
<b>BOLRTR21</b>	Yamaha Rear Flange M6x16mm (6pcs)





## Kill Switches

- |                   |  |
|-------------------|--|
| <b>Order Code</b> | <b>Description</b>   |
| <b>BUTKILL</b>    | Universal kill switch with tether (breaks circuit when tether is removed - Japanese)           |
| <b>BUTKILL05</b>  | Reverse universal kill switch with tether (Completes the circuit when tether is removed - KTM) |
| <b>BUTKILLCR</b>  | Honda CR   |
| <b>BUTKILLKX</b>  | Kawasaki KX  |
| <b>BUTKILLRM</b>  | Suzuki RM  |
| <b>BUTKILLYZ</b>  | Yamaha YZ  |
| <b>BUTKILL03</b>  | Universal on/ off type   |
| <b>BUTKILL07</b>  | Hi / Lo Beam   |
| <b>BUTKILLCRF</b> | Honda CRF 09>  |
| <b>BUTKILL11</b>  | Honda CRF250X/450X   |
| <b>BUTKILL09</b>  | Kawasaki KX250F/KX450F   |
| <b>BUTKILL15</b>  | KTM 85-660 02-13   |
| <b>BUTKILL13</b>  | Suzuki RM/RMZ/DRZ  |



For Road kill switches see Road/Electrics section.

## Quick Release Fuel Line Coupler

Simple in-line fuel hose coupler allows quick and safe removal of petrol tank without fuel spillage. Each end of the coupler features a valve mechanism which permits fuel flow when the coupler is secured, but instantly isolates the fuel when the coupler is released. Available for 6mm and 8mm fuel hose.

- |                   |               |
|-------------------|---------------|
| <b>Order Code</b> | <b>Fits</b>   |
| <b>FLCP06</b>     | 6mm fuel hose |
| <b>FLCP08</b>     | 8mm fuel hose |



## Fuel Hose & Clips

- |                   |                           |
|-------------------|---------------------------|
| <b>Order Code</b> | <b>Description</b>        |
| <b>FUP6MM</b>     | 7.5m / 25ft roll          |
|                   | Fuel hose for 6mm filters |
| <b>FUP8MM</b>     | 7.5m / 25ft roll          |
|                   | Fuel hose for 8mm filters |
| <b>HOSCLIP7</b>   | Hose clips 7.8mm (Per 10) |



## Fuel Filters

- |                   |   |
|-------------------|---|
| <b>Order Code</b> | <b>Description</b>                              |
| <b>FFTSTD</b>     | 6mm regular size inline filter (Per card of 10) |
| <b>FFTSQ</b>      | 6mm square MRC type filter (Per card of 30)     |
| <b>FFT001</b>     | 8mm inline filter (Per card of 10)              |

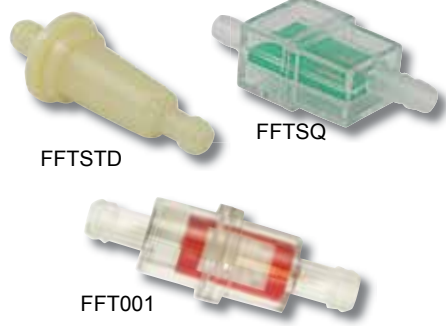

## Hour Meters

Hour meters record the actual running time of an engine to encourage correct servicing at regular intervals. The meter is accumulative and data is non-erasable.

- Works on any petrol engine, 2 or 4 stroke
- Low power consumption
- Easy installation
- Waterproof to IP68 standard
- Records and displays up to 99999 RPM (hour/tachometer) and 9999.9 hours (hour meter and hour/tachometer)
- Up to 2 year battery life, 17500 hours of standby time

- |                   |                    |
|-------------------|--------------------|
| <b>Order Code</b> | <b>Description</b> |
| <b>MTR002</b>     | Hour Meter         |
| <b>MTR004</b>     | Hour/Tacho         |



## Fuel Mixture Screw

Order Code: **TLSMIX11**



## Rear Brake Reservoir

Replacement rear brake reservoir and cap

Order Code: **BRKRES11**



## Fuel Taps



- |                   |   |
|-------------------|---|
| <b>Order Code</b> | <b>Description</b>                        |
| <b>FFTAP09</b>    | Dual on/off positions 6mm, plastic bodied |
| <b>FFTAP11</b>    | Dual on/off positions 8mm, plastic bodied |



## Fork Seals Off-Road

Japanese industry standard original equipment fork oil seal

### HONDA

Model	Year	Fork Seal Size	Order Code
CR 80	87-95	35 x 48 x 11	<b>FKS012</b>
CR 80	96-01	35 x 50 x 11	<b>FKS065</b>
CR 85	03>	37 x 50 x 11	<b>FKS013</b>
CR 125	87-89	43 x 54 x 11	<b>FKS038</b>
CR 125	90-91	45 x 57 x 11	<b>FKS039</b>
CR 125	92-93	43 x 54 x 9.5	<b>FKS063</b>
CR 125	94-96	43 x 55 x 9 / 9.5	<b>FKS045</b>
CR 125	97>	46 x 58 x 9 / 9.5	<b>FKS064</b>
CRF 150	07>	37 x 50 x 11	<b>FKS013</b>
CR 250	83-88	43 x 54 x 11	<b>FKS038</b>
CR 250	92-94	43 x 54 x 9.5	<b>FKS063</b>
CR 250	95	43 x 55 x 9 / 9.5	<b>FKS045</b>
CR 250	96	46 x 58 x 9 / 9.5	<b>FKS064</b>
CR 250	97>	47 x 58 x 10	<b>FKS054</b>
CRF 250 / X	04>	47 x 58 x 10	<b>FKS054</b>
XR 250	86>	41 x 53 x 8	<b>FKS003</b>
XR 400	96>	43 x 54 x 9.5	<b>FKS063</b>
CRF 450	02>	47 x 58 x 10	<b>FKS054</b>
CRF 450X	04>	47 x 58 x 10	<b>FKS054</b>
CR 500	84-88	43 x 54 x 11	<b>FKS038</b>
CR 500	89-91	45 x 57 x 11	<b>FKS039</b>
CR 500	92-94	43 x 54 x 9.5	<b>FKS063</b>
CR 500	95	43 x 55 x 9 / 9.5	<b>FKS045</b>
CR 500	96-02	46 x 58 x 9 / 9.5	<b>FKS064</b>
XR 600	85>	43 x 54 x 9.5	<b>FKS063</b>

### KAWASAKI

KX 60	85-06	30 x 42 x 10.5	<b>FKS007</b>
KX 65	00>	33 x 46 x 10.5	<b>FKS008</b>
KX 80	91-97	38 x 50 x 10.5	<b>FKS041</b>
KX 80	98-00	36 x 48 x 9.5	<b>FKS034</b>
KX 80 BW	92-97	36 x 48 x 9.5	<b>FKS034</b>
KX 85	01>	36 x 48 x 9.5	<b>FKS034</b>
KX 100	98>	36 x 48 x 9.5	<b>FKS034</b>
KX 125	88-89	43 x 55 x 9 / 9.5	<b>FKS045</b>
KX 125	90	41 x 53 x 8	<b>FKS003</b>
KX 125	91-95	43 x 55 x 9 / 9.5	<b>FKS045</b>
KX 125	96-01	46 x 58 x 9 / 9.5	<b>FKS064</b>
KX 125	02>	48 x 58.1 x 10.5	<b>FKS056</b>
KDX 200	94-95	41 x 53 x 8	<b>FKS003</b>
KDX 200	96>	43 x 55 x 9 / 9.5	<b>FKS045</b>
KDX 220	97>	43 x 55 x 9 / 9.5	<b>FKS045</b>
KLX 250	91-96	43 x 55 x 9 / 9.5	<b>FKS045</b>
KX 250	88	43 x 55 x 9 / 9.5	<b>FKS045</b>
KX 250	91-95	43 x 55 x 9 / 9.5	<b>FKS045</b>
KX 250	96-01	46 x 58 x 9 / 9.5	<b>FKS064</b>
KX 250	02>	48 x 58.1 x 10.5	<b>FKS056</b>
KXF 250	06>	47 x 58 x 10	<b>FKS054</b>
KXF 250	04>	48 x 58.1 x 10.5	<b>FKS056</b>
KLX 300	97>	43 x 55 x 9 / 9.5	<b>FKS045</b>
KXF 450	06>	48 x 58.1 x 10.5	<b>FKS056</b>
KX 500	88	43 x 55 x 9 / 9.5	<b>FKS045</b>
KX 500	91-95	43 x 55 x 9 / 9.5	<b>FKS045</b>
KX 500	96-05	46 x 58 x 9 / 9.5	<b>FKS064</b>

### KTM

KTM 50	98-01	32 x 42 x 8	<b>FKS035</b>
KTM 60	98-01	32 x 42 x 8	<b>FKS035</b>
KTM 65	97>	35 x 47 x 10	<b>FKS060</b>

### SUZUKI

RM 60	03>	30 x 42 x 10.5	<b>FKS007</b>
RM 65	03>	33 x 46 x 10.5	<b>FKS008</b>
RM 80	89-96	35 x 48 x 11	<b>FKS012</b>

### SUZUKI cont...

Model	Year	Fork Seal Size	Order Code
RM 80	97-02	39 x 52 x 11	<b>FKS031</b>
RM 85	02>	37 x 50 x 11	<b>FKS013</b>
RM 125	88	43 x 55 x 9 / 9.5	<b>FKS045</b>
RM 125	90	41 x 53 x 8	<b>FKS003</b>
RM 125	91-95	45 x 57 x 11	<b>FKS039</b>
RM 125	96-00	49 x 60 x 10	<b>FKS055</b>
RM 125	01>	47 x 58 x 10	<b>FKS054</b>
RM 250	88	43 x 55 x 9 / 9.5	<b>FKS045</b>
RM 250	90	41 x 53 x 8	<b>FKS003</b>
RM 250	91-95	45 x 57 x 11	<b>FKS039</b>
RM 250	96-00	49 x 60 x 10	<b>FKS055</b>
RM 250	01>	46 x 58 x 9 / 9.5	<b>FKS064</b>
RMX 250	91-98	45 x 57 x 11	<b>FKS039</b>
RMZ 250	04>	48 x 58.1 x 10.5	<b>FKS056</b>
DRZ 400	00>	49 x 60 x 10	<b>FKS055</b>
RMZ 450	05>	48 x 58.1 x 10.5	<b>FKS056</b>

### YAMAHA

YZ 80	93-01	36 x 48 x 9.5	<b>FKS034</b>
YZ 85	02>	36 x 48 x 9.5	<b>FKS034</b>
YZ 125	89-90	41 x 53 x 8	<b>FKS003</b>
YZ 125	91-95	43 x 55 x 9 / 9.5	<b>FKS045</b>
YZ 125	96-03	46 x 58 x 9 / 9.5	<b>FKS064</b>
YZ 125	04>	48 x 58.1 x 10.5	<b>FKS056</b>
YZ 250	89-90	41 x 53 x 8	<b>FKS003</b>
YZ 250	91-95	43 x 55 x 9 / 9.5	<b>FKS045</b>
YZ 250	96-03	46 x 58 x 9 / 9.5	<b>FKS064</b>
YZ 250	04>	48 x 58.1 x 10.5	<b>FKS056</b>
YZ 250F	01-03	46 x 58 x 9 / 9.5	<b>FKS064</b>
YZ 250F	04>	48 x 58.1 x 10.5	<b>FKS056</b>
WR 400F	98-03	46 x 58 x 9 / 9.5	<b>FKS064</b>
YZ 400/426/450F	98-03	46 x 58 x 9 / 9.5	<b>FKS064</b>
YZ 450F	04>	48 x 58.1 x 10.5	<b>FKS056</b>



## Fork Stroke Indicators

A very simple but handy accessory. These fork indicators simply slide onto fork legs against the dust seal. As the forks compress the indicator is pushed up the leg, clearly showing fork performance.

Order Code	Description
<b>FKSIND41</b>	41mm / Pair
<b>FKSIND43</b>	43mm / Pair
<b>FKSIND46</b>	46mm / Pair
<b>FKSIND47</b>	47mm / Pair
<b>FKSIND48</b>	48mm / Pair
<b>FKSIND50</b>	50mm / Pair





## Filtrex MX Oil Filters

Filtrex oil filters are used exclusively by the Monster Energy Yamaha MX Racing team in the FIM World and British MX Championships

Order Code	HiFlo Equiv	Champion Equiv	Application
<b>OIF021</b>	HF142	X313	Yamaha
<b>OIF030</b>	HF115	#	Honda
<b>OIF031</b>	HF141	#	Yamaha
<b>OIF034</b>	HF155	X320	KTM
<b>OIF035</b>	HF156	F303	KTM
<b>OIF040</b>	HF157	X335	KTM
<b>OIF044</b>	HF207	#	Kawasaki / Suzuki
<b>OIF045</b>	HF116	#	Honda
<b>OIF046</b>	HF139	#	Kawasaki / Suzuki
<b>OIF050</b>	HF154	#	Husqvarna
<b>OIF054</b>	HF655	#	KTM
<b>OIF055</b>	HF652	#	KTM
<b>OIF059</b>	HF140	#	Yamaha



Visit [www.bikeit.co.uk](http://www.bikeit.co.uk) for our full range of application lists

\* use of other brands codes for reference only



**Filtrex - OIF021**  
HiFlo - HF142  
Champion - X313



**Filtrex - OIF030**  
HiFlo - HF115  
Champion -



**Filtrex - OIF031**  
HiFlo - HF141  
Champion -



**Filtrex - OIF034**  
HiFlo - HF155  
Champion - X320



**Filtrex - OIF035**  
HiFlo - HF156  
Champion - F303



**Filtrex - OIF040**  
HiFlo - HF157  
Champion - X335



**Filtrex - OIF044**  
HiFlo - HF207  
Champion -



**Filtrex - OIF045**  
HiFlo - HF116  
Champion -



**Filtrex - OIF046**  
HiFlo - HF139  
Champion -



**Filtrex - OIF050**  
HiFlo - HF154  
Champion -



**Filtrex - OIF054**  
HiFlo - HF655  
Champion -



**Filtrex - OIF055**  
HiFlo - HF652  
Champion -

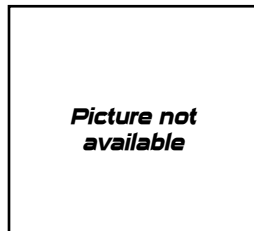

**Filtrex - OIF059**  
HiFlo - HF140  
Champion -

## Filtrex Foam MX Air Filters

New from the Filtrex camp comes a range of replacement foam air filters for off-road applications.

Featuring a double foam layer construction, the filter performs to allow maximum air flow in without sacrificing protection from particles and dirt. Resilient bonding agents prevents separation of foam components. Supplied non-oiled



OFF ROAD

### HONDA

Model	Year	Order Code
CR80 R	86-02	<b>AIRX091</b>
CR85 R	02-07	<b>AIRX091</b>
CR125 R	00-01	<b>AIRX079</b>
CR125 R	02-07	<b>AIRX064</b>
CRF150 F	03-13	<b>AIRX071</b>
CRF230 F	03-13	<b>AIRX071</b>
CR250 R	00-01	<b>AIRX079</b>
CR250 R	02-07	<b>AIRX064</b>
CRF250 R	04-09	<b>AIRX097</b>
CRF250 R	10-13	<b>AIRX055</b>
CRF250 X	04-13	<b>AIRX097</b>
XR250	86-04	<b>AIRX059</b>
XR400	96-05	<b>AIRX059</b>
CRF450 R	01-02	<b>AIRX086</b>
CRF450 R	03-08	<b>AIRX097</b>
CRF450 R	09-12	<b>AIRX055</b>
CRF450 X	04-13	<b>AIRX097</b>
CR500 R	00-02	<b>AIRX079</b>
XR600	85-02	<b>AIRX059</b>
XR650	93-13	<b>AIRX059</b>

### KAWASAKI

KX60	85-01	<b>AIRX040</b>
KX65	99-13	<b>AIRX042</b>
KX80	91-00	<b>AIRX077</b>
KX85	01-13	<b>AIRX077</b>
KX100	95-13	<b>AIRX077</b>

### KAWASAKI Cont...

Model	Year	Order Code
KX125	97-01	<b>AIRX060</b>
KX125	02-09	<b>AIRX095</b>
KLX250	06-12	<b>AIRX046</b>
KX250	97-01	<b>AIRX060</b>
KX250	02-09	<b>AIRX095</b>
KX250 F	04-05	<b>AIRX048</b>
KX250 F	06-13	<b>AIRX053</b>
KX450 F	05-13	<b>AIRX053</b>
KX500	87-03	<b>AIRX046</b>

### KTM

65 SX	97-13	<b>AIRX084</b>
85 SX	05-12	<b>AIRX044</b>
EXC all models	03-07	<b>AIRX044</b>
EXC all models	08-12	<b>AIRX068</b>
SX 125	07-10	<b>AIRX068</b>
SX 125	11-13	<b>AIRX093</b>
SX 125 4 str	01-06	<b>AIRX044</b>
SX 125 2 str	04-06	<b>AIRX044</b>
SX 250	07-10	<b>AIRX068</b>
SX 250	11-13	<b>AIRX093</b>
SX 250 4 str	01-06	<b>AIRX044</b>
SX 250 2 str	04-06	<b>AIRX044</b>
SX-F 250	07-10	<b>AIRX068</b>
SX-F 250	11-13	<b>AIRX093</b>
SX-F 450	07-10	<b>AIRX068</b>
SX-F 450	11-13	<b>AIRX093</b>

### SUZUKI

Model	Year	Order Code
RM65	03-12	<b>AIRX042</b>
RM80	86-01	<b>AIRX080</b>
RM85	02-13	<b>AIRX080</b>
RM125	96-01	<b>AIRX075</b>
RM125	02-03	<b>AIRX039</b>
RM125	04-11	<b>AIRX051</b>
RM250	96-01	<b>AIRX075</b>
RM250	02	<b>AIRX039</b>
RM250	03-11	<b>AIRX051</b>
RM-Z250	04-06	<b>AIRX048</b>
RM-Z250	07-12	<b>AIRX051</b>
DR-Z400	00-13	<b>AIRX082</b>
RMX450	10-13	<b>AIRX062</b>
RM-Z450	05-12	<b>AIRX051</b>

### YAMAHA

YZ80	93-01	<b>AIRX057</b>
YZ85	02-13	<b>AIRX073</b>
YZ125	97-12	<b>AIRX099</b>
WR250F	01-02	<b>AIRX099</b>
WR250F	03-12	<b>AIRX088</b>
YZ250	97-12	<b>AIRX099</b>
YZ250F	01-12	<b>AIRX099</b>
WR400F	99-01	<b>AIRX099</b>
YZ400F	98-99	<b>AIRX099</b>
WR426F	01-02	<b>AIRX099</b>
YZ426F	00-02	<b>AIRX099</b>
WR450F	03-12	<b>AIRX088</b>
YZ450F	03-09	<b>AIRX099</b>
YZ450F	10-13	<b>AIRX066</b>



## Air Filter Care Service Kit

This service kit contains a pump spray filter cleaner and aerosol of service oil for use with Filtrex performance air filters. Filters should be serviced every 2000 miles to maintain optimum performance.

Order Code: **AIRKIT01**





## NGK Spark Plugs

### NGK SPARK PLUG COVERS

Order Code	Type	Description
<b>SPKLB05EMH</b>	LB05EMH (8338)	90 degree rubber sheathed (14mm)
<b>SPKLB05F</b>	LB05F (8051)	90 degree elbow type - resin (14mm)
<b>SPKSB05F</b>	SB05F (8080)	Straight type - resin (14mm)
<b>SPKSD05F</b>	SD05F (8022)	Straight type - resin (10-12mm)
<b>SPKXD05F</b>	XD05F (8072)	102 degree elbow type (10-12mm)



MODEL	YEAR	STANDARD PLUG ORDERCODE	UPGRADE PLUG ORDERCODE
<b>Honda</b>			
CRF50F	04>	SPKCR6HSA	SPKCR6HIX
XR50	96-02	SPKCR6HSA	SPKCR6HIX
XR50R	03>	SPKCR6HSA	SPKCR6HIX
CRF70F	04>	SPKCR6HSA	SPKCR6HIX
CR80R, CR80R2	02>	SPKBR10EG	SPKBR10EIX
CR80R-D/E/F/2F/G/2G	ALL	SPKBR9ES	SPKBR9EIX
CR85R/R2	03-06	SPKBR10EG	SPKBR10EIX
CRF100F	04>	SPKCR7HSA	N/A
CR125R D-S-V	ALL	SPKBR9EG	SPKBR9EIX
CRF150R	07>	SPKCR8EH9	SPKCR8EHIX9
CRF230F	08>	SPKDR8EA9	SPKDR8EIX9
CR250 R3/R-D-H	ALL	SPKBR8EG	SPKBR8EIX
CR250R	05>	SPKBR9EGN8	N/A
CR250R-J	ALL	SPKBR9EG	SPKBR9EIX
CR250R-S-V	ALL	SPKBR8EG	SPKBR8EIX
CRF250R	04-09	N/A	SPKR0409B8
CRF250R	10>	N/A	SPKR0451B8
CRF250X	04>	N/A	SPKIMR8C9H
XR250RT/V	96-01	SPKCR9EH9	SPKCR9EHIX9
CRF450R	02-08	N/A	SPKIFR8H11
CRF450R	09>	N/A	SPKSILMAR9A9S
CRF450X	08>	N/A	SPKIFR8H11
CR500R-E-S-X	93>	SPKBR8EG	SPKBR8EIX
XR600R-V	ALL	SPKDR8EA9	SPKDR8EIX9

MODEL	YEAR	STANDARD PLUG ORDERCODE	UPGRADE PLUG ORDERCODE
<b>Kawasaki</b>			
KX60 A	83-97	SPKB9EG	SPKBR9EIX
KX60 B	98-01	SPKBR9EG	SPKBR9EIX
KX65	00-11	SPKBR10EG	SPKBR10EIX
KX80	92>	SPKR6252K105	N/A
KX80 C-R	81-91	SPKBR9EG	SPKBR9EIX
KX85	01>	SPKR6252K105	N/A
KX100	92-09	SPKR6252K105	N/A
KX100 A, B	89-91	SPKBR9EG	SPKBR9EIX
KX125	94-09	N/A	SPKBR9EIX
KX125 A	74-79	SPKB9EG	SPKBR9EIX
KX125 A, B	80-82	N/A	SPKBR9EIX
KX125 B, D-G, H	83-90	SPKBR10EG	SPKBR10EIX
KX125 J	92-93	SPKR6252K105	N/A
KDX200 E	89-94	SPKBR9ES	SPKBR9EIX
KDX200 H	95-04	SPKBR8ES	SPKBR8EIX
KDX250 D, E	91-95	SPKBR9ES	SPKBR9EIX
KLX250	93-97	SPKCR8E	SPKCR8EIX
KLX250 B	81-82	SPKBR7ES	SPKBR7EIX
KLX250 T	09>	SPKCR8E	SPKCR8EIX
KX250 D-H	86-91	SPKBR9EG	SPKBR9EIX
KX250 K, L, M	94-04	N/A	SPKBR8EIX
KX250 N	04-05	SPKCR8EB	SPKCR8EIX
KX250 T	06-10	SPKCR8E	SPKCR8EIX
KX250 YBF Fi	11>	SPKCR8EB9	N/A
KLX300 A, B	97-03	SPKCR8E	SPKCR8EIX
KX450 F	06>	SPKCR8EB9	N/A
KX500 A	83-84	SPKBR9EG	SPKBR9EIX
KLX650 C	93-96	SPKDR8EA9	SPKDR8EIX9

MODEL	YEAR	STANDARD PLUG ORDERCODE	UPGRADE PLUG ORDERCODE
<b>KTM</b>			
50 SX	09>	SPKLR8B	SPKCR8HIX
50 SX Junior/Senior LC	02	SPKBR10EG	SPKBR10EIX
50 SX Pro-Junior LC	03>	SPKBR8ECM	N/A
65 SX	03-07	SPKBR8ECM	N/A
65 SX	>03	SPKBR10EG	SPKBR10EIX
65 SX	08>	SPKLR8B	SPKCR8HIX
125 EXC, SX	01-07	N/A	SPKBR9EIX
200 EGS, EXC, MXC	98>	SPKBR8EG	SPKBR8EIX
200 EXC	06>	SPKBR8EG	SPKBR8EIX
200 EXC, SX	03>	N/A	SPKBR9EIX

MODEL	YEAR	STANDARD PLUG ORDERCODE	UPGRADE PLUG ORDERCODE
250 EXC	02>	SPKCR8EK	SPKCR8EIX
250 EXC	97>	SPKBR8ECM	N/A
250 EXC (2-Stroke)	06>	SPKBR7ES	SPKBR7EIX
250 EXC Racing (4-Stroke)	03>	SPKDCPR8E	SPKDCR8EIX
250 EXC-F (4-Stroke)	07>	SPKCR9EKB	SPKCR9EIX
250 SX-F (4-Stroke)	06>	SPKCR9EKB	SPKCR9EIX
400 EXC	02-08	SPKDCPR8E	SPKDCR8EIX
400 EXC, MXC, SX	99-02	SPKCR8EK	SPKCR8EIX
520 EXC, MXC, SX	99>	SPKCR8EK	SPKCR8EIX
525 EXC Racing, MXC, SX	03>	SPKDCPR8E	SPKDCR8EIX

MODEL	YEAR	STANDARD PLUG ORDERCODE	UPGRADE PLUG ORDERCODE
<b>Suzuki</b>			
JR50	ALL	SPKBR4HS	N/A
RM65	03>	SPKBR10EG	SPKBR10EIX
RM80 K	00>	SPKBR10ES	SPKBR10EIX
RM80T	ALL	SPKBR10EG	SPKBR10EIX
RM80X G-L	ALL	SPKB9EG	SPKBR9EIX
RM80X M-V	ALL	SPKB10EG	SPKBR10EIX
RM85	01>	SPKBR10ES	SPKBR10EIX
RM100 K	04>	SPKR6252K105	N/A
RM125 E-J	ALL	SPKBR9EG	SPKBR9EIX
RM125 K-M	ALL	SPKB9EG	SPKBR9EIX
RM250	99>	SPKBR8EG	SPKBR8EIX
RM250Z/D	ALL	SPKB8EG	SPKBR8EIX
RMX250K, L-S	89-95	N/A	SPKBR8EIX
RMX250RP	ALL	N/A	SPKBR9EIX
RMX250T	ALL	N/A	SPKBR9EIX
RM-Z250	04-06	SPKCR8EB	SPKCR8EIX
RM-Z250	07>	N/A	SPKCR8EIA10
DR350-S-R	94>	SPKCR9EK	SPKCR9EIX
DR-Z400	99-07	SPKCR8E	SPKCR8EIX
RM-Z450	04-06	N/A	SPKCR8EIB10
RM-Z450	07>	N/A	SPKDIMR8B10

MODEL	YEAR	STANDARD PLUG ORDERCODE	UPGRADE PLUG ORDERCODE
<b>Yamaha</b>			
PW50S	ALL	SPKBPR4HS	N/A
PW80K	ALL	SPKBP6HS	N/A
YZ80	79>	SPKBR9EG	SPKBR9EIX
YZ80	ALL	SPKB7HS	N/A
YZ80 B	ALL	SPKB8HS	N/A
YZ80 C/D	ALL	SPKB8ES	SPKBR8EIX
YZ80 E/F	ALL	SPKB10EG	SPKBR10EIX
YZ85	03>	SPKBR10EG	SPKBR10EIX
YZ125	05>	N/A	SPKBR9EIX
YZ125	74-91	SPKB9EG	SPKBR9EIX
YZ125	91-96	SPKBR9EG	SPKBR9EIX
YZ125	96-98	SPKB9EG	SPKBR9EIX
YZ125	98-05	SPKBR9EG	SPKBR9EIX
WR200E	ALL	SPKBR9ES	SPKBR9EIX
WR250F	01>	SPKCR8E	SPKCR8EIX
WR250F (S)	04-06	SPKCR8E	SPKCR8EIX
WR250F (S)	07>	SPKCR9E	SPKCR9EIX
WR250R	08>	SPKCR9EK	SPKCR9EIX
WR250X	08>	SPKCR9EK	SPKCR9EIX
WR250Z	93>	SPKB8EG	SPKBR8EIX
YZ250 (E-V)	ALL	SPKB8EG	SPKBR8EIX
YZ250A	ALL	SPKB8EG	SPKBR8EIX
YZ250E	ALL	SPKB8EG	SPKBR8EIX
YZ250F (4-Stroke)	01>	SPKCR8E	SPKCR8EIX
YZ250F (S)	04>	SPKCR8E	SPKCR8EIX
YZ250G	95	SPKB8EG	SPKBR8EIX
YZ250H	ALL	SPKB9EG	SPKBR9EIX
YZ250WR	>04	SPKB8EG	SPKBR8EIX
YZ250WR	05>	SPKBR8EG	SPKBR8EIX
WR450F (S)	04>	SPKCR8E	SPKCR8EIX
YZ450F	03>	SPKCR8E	SPKCR8EIX

## Moto-x Tyres

Order Code	Size	Tread	Fitment
<b>10"</b>			
TMX10250	250-10	965	F/R
<b>12"</b>			
TMX1280100	80/100-12	808	F/R
TMX1290100	90/100-12	965	F/R
<b>14"</b>			
TMX1460100	60/100-14	807	F/R
TMX1490100	90/100-14	991	F/R
<b>16"</b>			
TMX1690100	90/100-16	808	R
<b>17"</b>			
TMX1770100	70/100-17	981	F/R
<b>18"</b>			
TMX1814080	140/80-18	992	F/R
TMX18100100	100/100-18	991	F/R
TMX18110100	110/100-18	991	F/R
TMX18120100	120/100-18	991	F/R
<b>19"</b>			
TMX1910090	100/90-19	991	F/R
TMX1911090	110/90-19	991	F/R
TMX1912090	120/90-19	991	F/R
TMX1970100	70/100-19	807	F
<b>21"</b>			
TMX2180100	80/100-21	981	F/R
TMX219090	90/90-21	992	F/R

A great range of all-purpose MX tyres offering performance on all terrains.

Sizes available for youth bikes.

Block patterns provide optimum drive and corner grip.

Tyres supplied are Cougar brand wherever possible, if Cougar is not available Bike It will send an alternative brand of equivalent specification.

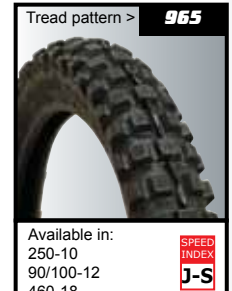
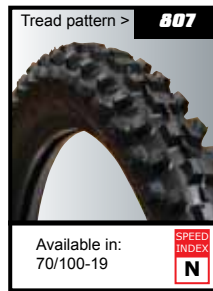

## Wheel & Bike Stripes

Biketek versatile tape rolls take wheel stripes one step further.

The rolls of tape mould to the contour of the surface being adhered to, making easy and effective work on wheels. Each roll is long enough to cover both sides of 2 wheels. The tape can also be used on fairing panels and bodywork for colour coding with greater visibility and safety. The tapes will flawlessly follow curves and panel shapes, simply apply by hand.

Order Code	Description
WST010	7mm reflective light blue
WST014	7mm reflective white
WST016	7mm reflective dark blue
WST018	7mm reflective red
WST020	7mm reflective orange
WST022	7mm reflective green
WST024	7mm reflective black
WST026	7mm reflective gold

WST5PC 5 pack wheel/body stripes 7mm (Best selling mixed colours)

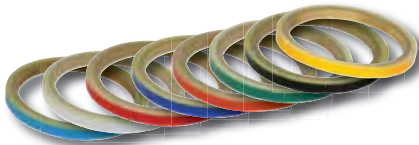

## Biketek Tyre & Wheel Bag

Heavy-duty transit and storage bag for motorcycle tyres and wheels.

Protects all types of tyres. Suitable for tyre sizes 16"-21". Made from robust oxford material. Features handle for carrying and hanging. PVC window for name / team tags. Elasticated seams with velcro closure.



Order Code: **TYRB01**

## CAPPA Dustcaps

Push-on / pull-off valve caps. Attaches to valve stem to prevent it being dropped or lost. Made from highly resistive thermoplastic rubber. Non-screw design makes pressure checks quick and easy. Watertight and airtight. Available in 9 colours

Order Code	Description
CPP004	Pink
CPP006	Black
CPP008	Red
CPP010	Silver
CPP012	Yellow
CPP014	Blue
CPP016	Green
CPP018	White
CPP020	Orange
CPP002	12 Pack



## Heavy Duty Rim Tapes

Replacement heavy duty rim tapes available in all rim sizes, protects inner tubes from internal rim and spoke nipples. Available in standard width and extra wide 30mm suitable for road and off-road use.

### EXTRA WIDE 30mm

Order Code	Rim
RTPAA	17"
RTPBB	18"
RTPCC	19"

### STANDARD

Order Code	Rim
RTP10	10"
RTP12	12"
RTP14	14"
RTP15	15"
RTP16	16"
RTP17	17"
RTP18	18"
RTP19	19"
RTP21	21"

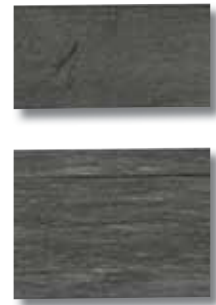

## Heavy Duty Butyl Inner Tubes

Premium quality motorcycle inner tubes. Manufactured from extra durable and hard-wearing butyl, providing excellent performance both on and off-road, featuring precision brass Schrader valve with dust cap.

Order Code	Valve	Size	Order Code	Valve	Size
<b>10"</b>					
ITB10250275	TR4/TR6	250/275-10	ITB17225250	TR4/TR6	225/250-17
ITB10250275A	TR87	250/275-10			
ITB10275300	TR4/TR6	275/300-10	<b>18"</b>		
ITB10275300A	TR87	275/300-10	ITB18400450	TR4/TR6	400/450-18
<b>12"</b>					
ITB12300350	TR4/TR6	300/325/350-12	<b>19"</b>		
<b>14"</b>					
ITB14225250	TR4/TR6	225/250-14	ITB19275300	TR4/TR6	275/300-19
ITB14250275	TR4/TR6	250/275-14	ITB19325400	TR4/TR6	325/350/400-19
ITB14350400	TR4/TR6	350/400-14	ITB19400450	TR4/TR6	400/450-19
<b>16"</b>					
ITB16275300	TR4/TR6	275/300-16	<b>21"</b>		
ITB16325350	TR4/TR6	325/350-16	ITB21250300	TR4/TR6	250/275/300-21

TR4 / TR6 = Straight valve  
TR87 = Angled valve



## ATV Tyres

Order Code	Size	Tread	Fitment	E-marked	Ply
<b>6"</b>					
TTQ145706EU	145/70-6	810	F / R	Non E-marked	2
<b>7"</b>					
TTQ1687FU	16x8-7	808	F / R	E-marked	4
<b>8"</b>					
TTQ1978EU	19x7-8	810B	F / R	Non E-marked	4
TTQ2078DU	20x7-8	888	F / R	E-marked	4
TTQ22118FU	22x11-8	808	F / R	E-marked	4
<b>9"</b>					
TTQ20119HU	20x11-9	818	F / R	E-marked	4
<b>10"</b>					
TTQ21710GF	21x7-10	878B	Front	E-marked	4
<b>11"</b>					
TTQ24911JR	24x9-11	980	F / R	E-marked	4
<b>12"</b>					
TTQ24812JR	24x8-12	980	F / R	E-marked	4
TTQ251012AR	25x10-12	920	Rear	E-marked	4
TTQ25812AF	25x8-12	920	Front	E-marked	4
TTQ251012BR	25x10-12	968	Rear	E-marked	4
TTQ25812BF	25x8-12	968	Front	E-marked	4
TTQ251012CR	25x10-12	978	Rear	E-marked	4
TTQ25812CF	25x8-12	978	Front	E-marked	4

A comprehensive range of tubeless tyres to fit the most popular quads and ATVs.

A carefully selected range of tread patterns cater for all terrains and ground conditions, from tarmac to deep mud, ensuring optimum grip and handling.

All tyres are E-marked (except where indicated)

Tyres supplied are Cougar brand wherever possible – if Cougar is not available Bike It will send an alternative brand of equivalent specification.

Tread pattern > **808**



Available in:  
16x8-7  
22x11-8

Tread pattern > **810**



Available in:  
145/70-6  
19x7-8 - 810B

Tread pattern > **810B**



Available in:  
19x7-8

Tread pattern > **818**



Available in:  
20x11-9

Tread pattern > **878B**



Available in:  
21x7-10

Tread pattern > **888**



Available in:  
20x7-8

Tread pattern > **920**



Available in:  
25x10-12  
25x8-12

Tread pattern > **968**



Available in:  
25x10-12  
25x8-12

Tread pattern > **978**



Available in:  
25x10-12  
25x8-12

Tread pattern > **980**



Available in:  
24x8-12  
24x9-11

## Armstrong MX Off-Road Front Floating Oversize MX Brake Disc with Caliper adaptor

- 270mm Oversize front disc creates greater surface area for increased braking.
  - Conversion adaptor kit included to relocate caliper.
  - Wavy contour disc - optimises pad contact and performance.
  - Premium Japanese induction hardened stainless steel
  - Laser cut for perfection and accuracy
  - Diamond ground finish
- (All discs are sold individually)

**Developed & Used By  
Monster Energy Yamaha  
Racing MX Team**



Order Code	Model	Year
------------	-------	------

### HONDA

<b>BKF306</b>	CR 125 R4-R8	04-08
<b>BKF306</b>	CR 250 R4-R8	04-08
<b>BKF306</b>	CRF 250 F4-FA	04-12
<b>BKF306</b>	CRF 250 R4-RA	04-12
<b>BKF306</b>	CRF 250 X4-XA	04-12
<b>BKF306</b>	CRF 450 R4-RA	04-12
<b>BKF306</b>	CRF 450 X5-X9	05-09

### HUSABERG

<b>BKF324</b>	400-650	99-05
---------------	---------	-------

### KAWASAKI

<b>BKF312</b>	KX 125 M1-M3	03-05
<b>BKF318</b>	KX 125 M6F-M9F	06-09
<b>BKF312</b>	KX 250 M1-R1	03-05
<b>BKF312</b>	KX 250 F N (4T)	04-05
<b>BKF318</b>	KX 250 F T (4T)	06-08
<b>BKF318</b>	KX 250 F W/X	09-12
<b>BKF318</b>	KX 250 R6F-R8F (2T)	06-08
<b>BKF318</b>	KLX 450 R	08-12
<b>BKF318</b>	KX 450 F D/E	06-12

### KTM

<b>BKF324</b>	EXC 125-620 with 260mm rotor	92-12
<b>BKF324</b>	MX 125-600 with 260mm rotor	92-12
<b>BKF324</b>	SX 125-625 with 260mm rotor	92-12

### SUZUKI

<b>BKF330</b>	RM 125	89-08
<b>BKF330</b>	DR 250	95-00
<b>BKF330</b>	DR-Z 250	01-07
<b>BKF330</b>	RM 250	89-09
<b>BKF330</b>	RMX 250	89-99
<b>BKF312</b>	RM-Z 250	04-06
<b>BKF342</b>	RM-Z 250	07-12
<b>BKF330</b>	DR-Z 400	00-08
<b>BKF342</b>	RM-Z 450	05-12

### YAMAHA

<b>BKF348</b>	YZ 125 N-Z	01-12
<b>BKF348</b>	WR 250 FN-FZ (4T)	01-12
<b>BKF348</b>	YZ 250 N-Z (2T)	01-08
<b>BKF348</b>	YZ 250 FN-FZ (4T)	01-08
<b>BKF354</b>	YZ 250 / F	08->
<b>BKF348</b>	WR 400 FN (4T)	01
<b>BKF348</b>	WR 426 FN-FP (4T)	01-02
<b>BKF348</b>	YZ 426 FN-FP (4T)	01-02
<b>BKF348</b>	WR 450 FR-FZ (4T)	03-12
<b>BKF348</b>	YZ 450 FR-FZ	03-08
<b>BKF354</b>	YZ 450 F	08->

**ARMSTRONG  
BRAKE DISCS**

### Brake Disc Display Plinths

Alloy display plinths with ARMSTRONG printed logo.

Plinth holds one MX solid disc or one front floating disc for retail display.

<b>Order Code</b>	<b>Holds</b>
<b>BKRPOS09</b>	MX Solid Disc
<b>BKRPOS11</b>	Front Floating Disc





## Armstrong MX Off-Road Front Solid Wavy Brake Discs

Armstrong MX discs feature a unique wavy design, optimising performance with a more efficient area of pad contact. Manufactured from premium Japanese induction hardened stainless steel, each disc is laser cut to ensure greater perfection and accuracy than machine stamped discs. Diamond ground for the perfect finish. Armstrong MX wavy discs provide a lightweight performance product compared to OEM discs.



FRONT			
Order Code	Model	Year	Diameter (mm)

HONDA			
BKF115	CR 85R 3-B7	03-07	220
BKF136	CR 125 R N-R	92-94	240
BKF112	CR 125 RS-R7	95-07	240
BKF136	XLR 125	98-01	240
BKF154	CRF 150F 3-7	03-07	240
BKF157	CRF 150R/RB 7-9	07-09	220
BKF136	CRF230 F4-F9	04-09	240
BKF136	CR 250R N-R	92-94	240
BKF112	CR 250 RS-R7	95-07	240
BKF112	CRF 250F 4-A	04-12	240
BKF112	CRF 250R 4-A	04-12	240
BKF112	CRF 250X 4-A	04-12	240
BKF136	CRM 250	91-98	240
BKF136	XR250 / R	91-04	240
BKF136	XR250 MD30	00-05	240
BKF136	XR400 R	96-04	240
BKF112	CRF 450R 2-A	02-12	240
BKF112	CRF 450X 5-9	05-09	240
BKF136	CR 500R N-R	92-94	240
BKF112	CR 500R S-1	95-01	240
BKF136	XR600 R	91-00	240
BKF136	XR650 R	00-07	240

KAWASAKI			
BKR292	KX 65 A1-AAF	00-12	180
BKF151	KX 80 R2-W3	92-00	220
BKF118	KX 85 A/B1-AA/BAF	01-12	220
BKF151	KX 100 B/C	91-00	220
BKF139	KX 125 G/H/J/K/L	89-02	250
BKF121	KX 125 M1-M3	03-05	250
BKF133	KX 125 M6F-M9F	06-09	250
BKF139	KLX 250 R	93-94	250
BKF139	KX 250 G/H/J/K/L	89-02	250
BKF121	KX 250 M1-R1	03-05	250
BKF121	KX 250 F N (4T)	04-05	250
BKF133	KX 250 F T (4T)	06-08	250
BKF133	KX 250 F W/X	09-12	250
BKF133	KX 250 R6F-R8F (2T)	06-08	250
BKF139	KLX 300	97-07	250
BKF103	KLX 400 R	03-04	250
BKF133	KLX 450 R	08-12	250
BKF133	KX 450 F D/E	06-12	250
BKF139	KX 500 E	89-04	250

KTM			
BKF148	60 SX	98-00	198
BKF148	65 SX	00-03	198
BKF124	65 SX	04-08	198
BKF124	SX 65	09-12	198
BKF130	SX 85	03-12	220
BKF109	EXC 125-620 with 260mm rotor	92-12	260

FRONT			
Order Code	Model	Year	Diameter (mm)

KTM cont...			
BKF109	MX 125-600 with 260mm rotor	92-12	260
BKF109	SX 125-625 with 260mm rotor	92-12	260

SUZUKI			
BKR292	RM 65	03-05	180
BKF142	RM 80	86-01	200
BKF142	RM 85	02-04	200
BKF106	RM 85	05-12	220
BKF118	RM 100	03	220
BKF103	RM 125	89-09	250
BKF103	DR 250	95-00	250
BKF103	DR-Z 250	01-07	250
BKF103	RM 250	89-09	250
BKF103	RMX 250	89-99	250
BKF121	RM-Z 250	04-06	250
BKF127	RM-Z 250	07-12	250
BKF103	DR-Z 400	00-08	250
BKF127	RM-Z 450	05-12	250

YAMAHA			
BKF106	YZ 80	93-01	220
BKF106	YZ 85	02-12	220
BKF145	YZ 125 D-M	92-00	245
BKF103	YZ 125 N-Z	01-12	250
BKF145	WR 250 ZB-ZK	91-98	245
BKF103	WR 250 FN-FZ (4T)	01-12	250
BKF160	WR 250 RX-RY	08-12	250
BKF145	YZ 250 D-M (2T)	92-00	245
BKF103	YZ 250 N-Z (2T)	01-12	250
BKF103	YZ 250 FN-FZ (4T)	01-12	250
BKF145	WR 400 FK-FM (4T)	98-00	245
BKF103	WR 400 FN (4T)	01	250
BKF145	YZ 400 FK-FL (4T)	98-99	245
BKF103	WR 426 FN-FP (4T)	01-02	250
BKF145	YZ 426 FM (4T)	00	245
BKF103	YZ 426 FN-FP (4T)	01-02	250
BKF103	WR 450 FR-FZ (4T)	03-12	250
BKF103	YZ 450 FR-FZ	03-12	250



## Armstrong MX Off-Road Rear Solid Wavy Brake Discs

Armstrong MX discs feature a unique wavy design, optimising performance with a more efficient area of pad contact. Manufactured from premium Japanese induction hardened stainless steel, each disc is laser cut to ensure greater perfection and accuracy than machine stamped discs. Diamond ground for the perfect finish. Armstrong MX wavy discs provide a lightweight performance product compared to OEM discs.



REAR			
Order Code	Model	Year	Diameter (mm)

HONDA			
BKR204	CR 80 R	92-02	190
BKR204	CR 85 R	03-07	190
BKR272	CR 125 RK-RV	89-97	220
BKR216	CR 125 RW-R1	98-01	240
BKR232	CR 125 R2-R7	02-07	240
BKR296	CRF 150R/RB 7-9	07-09	190
BKR232	CRF 230F	04-09	240
BKR272	CR 250 RK-RT	89-96	220
BKR216	CR 250 RV-R1	97-01	240
BKR232	CR 250 R2-R7	02-07	240
BKR232	CRF 250 F4-F9	04-09	240
BKR232	CRF 250 R4-RA	04-12	240
BKR232	CRF 250 X4-X9	04-09	240
BKR276	XR250 / R	91-04	220
BKR276	CRM250	91-98	220
BKR276	XR250 MD30	00-05	220
BKR276	XR400 R	96-04	220
BKR232	CRF 450 R2-R	02-12	240
BKR232	CRF 450 X5-X9	05-09	240
BKR272	CR 500 RK-R1	89-01	220
BKR276	XR600 RM-RY	91-00	220

KAWASAKI			
BKR292	KX 65 A1-AAF	00-12	180
BKR260	KX 80 L1-W3	88-00	185
BKR224	KX 85 A/B1-AA/BAF	01-12	184
BKR260	KX 100 A/B/C	89-00	185
BKR280	KX 125 G/H/J/K/L	89-02	220
BKR236	KX 125 M	03-08	240
BKR280	KX 250 G/H/J/K/L	89-02	220
BKR236	KX 250 M1-R1	03-05	240
BKR236	KX 250 F N (4T)	04-05	240
BKR236	KX 250 F T (4T)	06-08	240
BKR236	KX 250 F W/X	09-12	240
BKR236	KX 250 R6F-R8F (2T)	06-08	240
BKR256	KLX 400 R	03-04	220
BKR236	KLX 450 R	08-12	240
BKR236	KX 450 F D/E	06-12	240
BKR280	KX 500 E	89-04	220

KTM			
BKR288	60 SX	00	160
BKR288	65 SX	00-03	160

REAR			
Order Code	Model	Year	Diameter (mm)

KTM cont...			
BKR244	65 SX	04-08	160
BKR244	SX 65	09-12	160
BKR252	SX 85	03-12	200
BKR212	EXC 125-620	92-12	220
BKR212	MX 125-600	92-12	220
BKR212	SX 125-625	92-12	220

SUZUKI			
BKR292	RM 65	03-05	180
BKR260	RM 80	90-01	185
BKR260	RM 85	02-04	185
BKR240	RM 85	05-12	200
BKR224	RM 100	03	184
BKR256	RM 125 J-W	88-98	220
BKR268	RM 125 K6-K9	06-09	240
BKR220	RM 125 X-K5	99-05	240
BKR284	DR 250	95-00	220
BKR284	DR-Z 250	01-07	220
BKR256	RM 250 H-W	87-98	220
BKR268	RM 250 K6-XCK8	06-09	240
BKR220	RM 250 X-K5	99-05	240
BKR256	RMX 250	89-99	220
BKR236	RM-Z 250	04-06	240
BKR248	RM-Z 250	07-12	240
BKR256	DR-Z 400	00-08	220
BKR248	RM-Z 450	05-12	240

YAMAHA			
BKR208	YZ 80	93-01	190
BKR208	YZ 85	02-12	190
BKR264	YZ 125 K-N	98-01	240
BKR228	YZ 125 P-Z	02-12	245
BKR264	WR 250 FN (4T)	01	240
BKR228	WR 250 FP-FZ (4T)	02-12	245
BKR264	WR 250 ZK (2T)	98	240
BKR203	WR 250 RX-RY	08-12	230
BKR264	YZ 250 K-N (2T)	98-01	240
BKR228	YZ 250 P-Z (2T)	02-12	245
BKR264	YZ 250 FN (4T)	01	240
BKR228	YZ 250 FP-FZ (4T)	02-12	245
BKR264	WR 400 FL-FN (4T)	99-01	240
BKR264	YZ 400 FL (4T)	99	240
BKR264	WR 426 FN (4T)	01	240
BKR228	WR 426 FP (4T)	02	245
BKR264	YZ 426 FM-FN (4T)	00-01	240
BKR228	YZ 426 FP (4T)	02	245
BKR228	WR 450 FR-FZ	03-12	245
BKR228	YZ 450 FR-FZ	03-12	245



## Standard - Triple S Chains

Standard grade motorcycle drive chain available in 420 and 428 sizes.

Triple-S Standard chains offer all the performance required from smaller capacity motorcycles requiring this grade of roller chain.

Produced in an OE facility, Triple S Standard chains are quality engineered and manufactured to guarantee trouble free strength and durability.

Order Code	Length
------------	--------

### 420 Standard

CHS420078	420-78L
CHS420084	420-84L
CHS420086	420-86L
CHS420096	420-96L
CHS420098	420-98L
CHS420100	420-100L
CHS420102	420-102L
CHS420104	420-104L
CHS420106	420-106L
CHS420108	420-108L
CHS420110	420-110L
CHS420112	420-112L
CHS420114	420-114L
CHS420116	420-116L
CHS420118	420-118L
CHS420120	420-120L
CHS420122	420-122L
CHS420124	420-124L
CHS420126	420-126L
CHS420130	420-130L
CHS420136	420-136L
CHS420250*	420 (600L) x 25' roll

### 428 Standard

CHS428100	428-100L
CHS428102	428-102L
CHS428104	428-104L
CHS428106	428-106L
CHS428108	428-108L
CHS428110	428-110L
CHS428112	428-112L
CHS428114	428-114L
CHS428116	428-116L
CHS428118	428-118L
CHS428120	428-120L
CHS428122	428-122L
CHS428124	428-124L
CHS428126	428-126L
CHS428128	428-128L

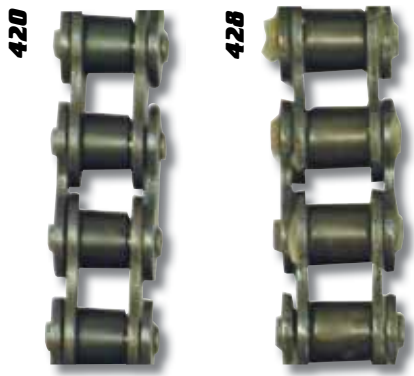

Order Code	Length
------------	--------

### 428 Standard cont...

CHS428130	428-130L
CHS428132	428-132L
CHS428134	428-134L
CHS428136	428-136L
CHS428138	428-138L
CHS428250*	428 (600L) x 25' roll

\* 25' rolls exclude connecting links

## Connecting Links

Packs of spare connecting links for Triple-S chain, available in spring-clip and rivet link types.

Order Code	Type	Qty
CHLSS420	420 Spring	10pcs
CHLSS428	428 Spring	10pcs
CHLRS420	420 Rivet	10pcs
CHLRS428	428 Rivet	10pcs

Spring Link



Rivet Link



## Heavy Duty - Triple S Chains

Heavy Duty grade motorcycle drive chain available in 415, 420, 428 and 520 sizes.

Triple-S Heavy Duty chains offer all the performance required from road and off-road motorcycles requiring this grade of roller chain.

Produced in an OE facility, Triple S Heavy Duty chains are quality engineered and manufactured to guarantee trouble free strength and durability.

Order Code	Length
------------	--------

### 415 Heavy Duty

CHH415120	415H-120L
-----------	-----------

### 420 Heavy Duty

CHH420120	420H-120L
CHH420126	420H-126L
CHH420130	420H-130L

### 428 Heavy Duty

CHH428104	428H-104L
CHH428106	428H-106L
CHH428108	428H-108L
CHH428110	428H-110L
CHH428112	428H-112L
CHH428114	428H-114L
CHH428116	428H-116L
CHH428118	428H-118L
CHH428120	428H-120L
CHH428122	428H-122L
CHH428124	428H-124L
CHH428126	428H-126L
CHH428128	428H-128L
CHH428130	428H-130L
CHH428132	428H-132L
CHH428134	428H-134L
CHH428136	428H-136L
CHH428138	428H-138L
CHH428140	428H-140L
CHH428142	428H-142L
CHH428146	428H-146L
CHH428250*	428H (600L) 25' roll

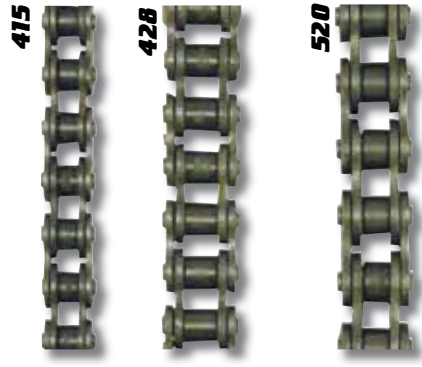

### 520 Heavy Duty

CHH520100	520H-100L
CHH520102	520H-102L
CHH520104	520H-104L
CHH520106	520H-106L
CHH520108	520H-108L
CHH520110	520H-110L
CHH520112	520H-112L
CHH520114	520H-114L
CHH520116	520H-116L
CHH520118	520H-118L
CHH520120	520H-120L
CHH520130	520H-130L
CHH520250*	520H (480L) 25' roll

\* 25' rolls exclude connecting links

## Connecting Links

Packs of spare connecting links for Triple-S chain, available in spring-clip and rivet link types.

Order Code	Type	Qty
CHLSH415	415H Spring	10pcs
CHLSH420	420H Spring	10pcs
CHLSH428	428H Spring	10pcs
CHLSH520	520H Spring	10pcs
CHLRH415	415H Rivet	10pcs
CHLRH420	420H Rivet	10pcs
CHLRH428	428H Rivet	10pcs
CHLRH520	520H Rivet	10pcs

Spring Link



Rivet Link



## Solid Bush - Triple S Chains

Solid Bush motorcycle drive chain available in Standard 420, Heavy Duty 428 and 520 sizes. Solid Bush chains utilise the same links and rollers as the equivalent Standard or Heavy Duty chains, but use a solid bushing instead of a split bushing inside the roller. This solid bushing increases wear resistance of the chain and minimises chain elongation, making the chains a worthy upgrade. Suitable for road and off-road applications. Produced in an OE facility, quality engineered and manufactured to guarantee trouble free strength and durability.

Order Code	Length
------------	--------

420 Solid Bush Standard	
CHU420078	420-78L
CHU420090	420-90L
CHU420110	420-110L
CHU420120	420-120L
CHU420126	420-126L

428 Solid Bush Heavy Duty	
CHU428100	428-100L
CHU428114	428-114L
CHU428116	428-116L
CHU428118	428-118L
CHU428120	428-120L
CHU428122	428-122L
CHU428124	428-124L



428 Solid Bush Heavy Duty cont...	
CHU428134	428-134L
CHU428138	428-138L
CHU428142	428-142L

520 Solid Bush Heavy Duty	
CHU520100	520-100L
CHU520110	520-110L
CHU520112	520-112L
CHU520114	520-114L
CHU520116	520-116L
CHU520120	520-120L
CHU520130	520-130L

### Connecting Links

Packs of spare connecting links for Triple-S chain, available in spring-clip and rivet link types.

Order Code	Type	Qty
CHLSU420	420 Spring	10pcs
CHLSU428	428 Spring	10pcs
CHLSU520	520 Spring	10pcs
CHLRU420	420 Rivet	10pcs
CHLRU428	428 Rivet	10pcs
CHLRU520	520 Rivet	10pcs



**NEW**

## O-Ring Black

Heavy duty O-Ring grade motorcycle drive chain available in 428 and 520 sizes. Featuring a rubber O-ring between the inner and outer link, O-Ring chains both retain the lubricant sealed within the pin and bushing and prevent dirt working into the chain, prolonging chain longevity. Triple-S O-Ring chains offer all the performance required from larger capacity road and off-road motorcycles requiring this grade of roller chain. Produced in an OE facility, Triple S O-Ring chains are quality engineered and manufactured to guarantee trouble free strength and durability. Nickel plate finish.

Order Code	Length
------------	--------

428 O-Ring Black	
CHK428100	428-100L
CHK428104	428-104L
CHK428108	428-108L
CHK428110	428-110L
CHK428112	428-112L
CHK428114	428-114L
CHK428116	428-116L
CHK428118	428-118L
CHK428120	428-120L
CHK428122	428-122L
CHK428124	428-124L
CHK428126	428-126L
CHK428128	428-128L
CHK428130	428-130L
CHK428132	428-132L
CHK428134	428-134L
CHK428136	428-136L

Order Code	Length
------------	--------

428 O-Ring Black cont...	
CHK428138	428-138L
CHK428140	428-140L
CHK428142	428-142L

520 O-Ring Black	
CHK520098	520-98L
CHK520100	520-100L
CHK520102	520-102L
CHK520104	520-104L
CHK520106	520-106L
CHK520108	520-108L
CHK520110	520-110L
CHK520112	520-112L
CHK520114	520-114L
CHK520116	520-116L
CHK520118	520-118L
CHK520120	520-120L



### Connecting Links

Packs of spare connecting links for Triple-S chain, available in spring-clip and rivet link types.

Order Code	Type	Qty
CHLSK428	428	5pcs
CHLSK520	520	5pcs
CHLRK428	428	5pcs
CHLRK520	520	5pcs



**NEW**

## O-Ring Gold - Triple S Chains

These chains incorporate a rubber O-shaped seal that fits between the inner and outer links. This seal ensures that the grease between the pin and solid bush is retained and offers permanent internal lubrication. With the dual purpose of stopping dirt working into the chain, the seals help prolong the life of the chain.

Order Code	Length
------------	--------

420 Extra Heavy DUTY	
CHO420130	420XHO-130L
CHO420132	420XHO-132L
CHO420136	420XHO-136L
CHO420142	420XHO-142L

520 Extra Heavy DUTY	
CHO520098	520XHO-98L
CHO520102	520XHO-102L
CHO520104	520XHO-104L
CHO520106	520XHO-106L
CHO520108	520XHO-108L
CHO520110	520XHO-110L
CHO520112	520XHO-112L
CHO520114	520XHO-114L
CHO520116	520XHO-116L
CHO520118	520XHO-118L
CHO520120	520XHO-120L
CHO52075*	520XHO-473L (7.5m roll)

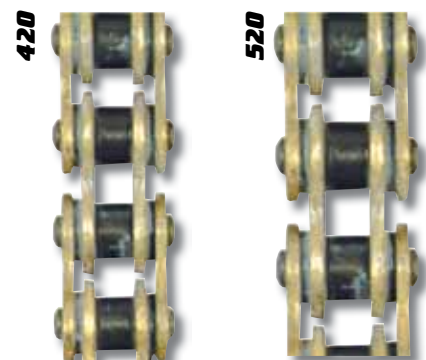

### Connecting Links

Packs of spare connecting links for Triple-S chain, available in spring-clip and rivet link types.

Order Code	Type	Qty
CHLSO420	420XHO spring	5pcs
CHLSO520	520XHO spring	5pcs
CHLRO420	420XHO rivet	5pcs
CHLRO520	520XHO rivet	5pcs





A winning combination of two proven products - Triple S chain and JT sprockets.  
 Triple S chain, as used by and developed by Team Yamaha UK's Superbike and MX teams, is the perfect replacement chain for today's motorcycles. Available in X-ring, O-ring, HD and Standard options.  
 To complement the chain, Bike It utilise JT sprockets to offer a comprehensive range of Chain & Sprocket kits. JT Sprockets are Japanese made from C45 steel (rear sprockets) and C45 steel/ SCM415 chromoly (front sprockets).  
 The listed chain and sprocket kits are comprised of the correct combination sprockets and chain type/grade for the bikes as stipulated by the manufacturer. Use of alternative chain will render warranty claims void - use the detailed chain grade only!

Please note, if the correct length of chain is not available, Bike It will send an alternative longer length that needs to be cut to the correct size.

Model	Year	Front	Rear	Notes	Chain	Manufacturers Recommended Chain Grade	STD	HD	O-RING
-------	------	-------	------	-------	-------	---------------------------------------	-----	----	--------

\* 513-15 = 566-15

**HONDA MX**

CRF50 F 4/5/6/7/8/9/A/B/C	04-12	1256-14	1213-37		420-78	STD	JTKHCRF5A	#	#
CRF70 F 4/5/6/7/8/9/A/B/C	04-12	1256-15	1214-36		420-86	STD	JTKHCRF7A	#	#
CR80 R	96-02	1257-15	217-49	Conversion to 428 chain / Ally rear	428-116	HD	JTKHCR80A	#	#
CRF80 F-4/5/6/7/8/9/A/B/C	04-12	252-14	1214-46		420-110	HD	JTKHCRF8A	#	#
CR85 R3-R4	03-04	1257-15	217-50	Conversion to 428 chain	428-116	HD	JTKHCR85A	#	#
CR85 RB-3,4 Expert	03-04	1257-15	217-56	Conversion to 428 chain	428-124	HD	JTKHCR85B	#	#
CR85 R-5,6,7	05-07	1257-15	217-49	Conversion to 428 chain / Ally rear	428-116	HD	JTKHCR85C	#	#
CR85 RB-5,6,7 Expert	05-07	1257-15	217-55	Conversion to 428 chain	428-124	HD	JTKHCR85D	#	#
CRF100 F-4/5/6/7/8/9/A/B/C	04-12	274-14	1204-50		428-118	HD	JTKHCRF1A	#	#
CR125 R-W,X	98-99	326-13	210-51	Ally rear	520-114	HD	JTKHCR125B	#	#
CR125 R-Y,1	00-01	326-13	210-52	Ally rear	520-114	HD	JTKHCR125A	#	#
CR125 R-2	02	326-13	210-51	Ally rear	520-114	HD	JTKHCR125B	#	#
CR125 R-3	03	326-13	210-52	Ally rear	520-116	HD	JTKHCR125C	#	#
CR125 R-4,5,6,7	04-07	1323-13	210-52	Ally rear	520-116	HD	JTKHCR125D	#	#
CRF150 F-3,4,5	03-05	327-13	210-48	Ally rear	520-112	HD	JTKHCRF15D	#	#
CRF150 F-6/7/8/9/A/B/C	06-12	327-13	210-47	Ally rear	520-104	HD	JTKHCRF15A	#	#
CRF150 R-7,8,9,A	07-10	1310-15	215-50		420-120	HD	JTKHCRF15B	#	#
CRF150 RB-7,8,9,A,B,C	07-12	1310-15	215-56		420-126	HD	JTKHCRF15C	#	#
CRF230 F-3,4,5,6,7,8,9,A,B,C	03-12	327-13	210-50	Ally rear	520-110	HD	JTKHCRF2D	#	#
CRF230 L-8,9,A	08-10	287-13	210-39	Ally rear	520-110	HD	JTKHCRF2F	#	#
CRF230 M-9,A	09-10	287-13	210-38		520-100	HD	JTKHCRF2E	#	#
CR250 RT,RV,RW,RX,R,Y,R-1,R-2	96-02	284-13	210-50	Ally rear	520-114	HD	JTKHCR250A	#	#
CR250 R-3	03	284-13	210-48	Ally rear	520-114	HD	JTKHCR250B	#	#



Model	Year	Front	Rear	Notes	Chain	Manufacturers Recommended Chain Grade	STD	HD	O-RING
<b>HONDA MX cont...</b>									
CR250 R-4	04	284-13	210-50	Ally rear	520-114	HD	#	JTKHCR250C	#
CR250 R-5	05	284-13	210-49	Ally rear	520-116	HD	#	JTKHCR250E	#
CR250 R-6,7,8	06-08	284-13	210-49	Ally rear	520-114	HD	#	JTKHCR250D	#
CRF250 X 4-A,B,C	04-11	1323-14	210-53	Ally rear	520-116	HD	#	JTKHCRF2A	#
CRF250 R 4-A	04-10	1323-13	210-51	Ally rear	520-114	HD	#	JTKHCRF2B	#
CRF250 R B,C	11-12	1323-13	210-49	Ally rear	520-116	HD	#	JTKHCRF2C	#
XR400 RT-R4	96-04	1322-15	210-45	Ally rear	520-108	O-RING	#	#	JTKHXR4A
CRF450 R2-R3	02-03	284-13	210-50	Ally rear	520-114	HD	#	JTKHCRF4A	#
CRF450 R4-RA B,C	04-12	284-13	210-48	Ally rear	520-114	HD	#	JTKHCRF4B	#
CRF450 X-5,6,7,8,9,A	05-10	284-13	210-51	Ally rear	520-116	HD	#	JTKHCRF4C	#
<b>KAWASAKI MX</b>									
KX60 A1-B19	83-03	546-13	464-44	Ally rear	420-104	STD	JTKKKX60A	#	#
KX65 A1-A2	00-01	555-13	1466-46	Conversion to 428 chain	428-108	HD	#	JTKKKX65A	#
KX65 A3-ADF	02-13	555-13	1466-47	Conversion to 428 chain	428-110	HD	#	JTKKKX65B	#
KX80 Y1-Y3 Big Wheel	98-00	555-13	462-51	Conversion to 428 chain / Ally rear	428-130	HD	#	JTKKKX80A	#
KX85 A1-ADF	01-13	555-14	462-50	Conversion to 428 chain	428-120	HD	#	JTKKKX85B	#
KX85 B1-BAF Big Wheel	01-10	555-13	462-51	Conversion to 428 chain / Ally rear	428-130	HD	#	JTKKKX85A	#
KX100 D1-DDF, C3	01-13	555-13	462-51	Conversion to 428 chain / Ally rear	428-124	HD	#	JTKKKX100A	#
KX125 L2-L4	00-02	1445-12	460-49	Ally rear	520-110	HD	#	JTKKKX125A	#
KX125 M1	03	1445-13	460-51	Ally rear	520-110	HD	#	JTKKKX125B	#
KX125 M2-M8F	04-08	1445-13	460-51	Ally rear	520-114	HD	#	JTKKKX125C	#
KX250 L1-L3	99-01	565-14	460-49	Ally rear	520-114	HD	#	JTKKKX250A	#
KX250 L4, M1-M3	02-05	565-13	460-49	Ally rear	520-114	HD	#	JTKKKX250B	#
KX250 F N1-N2	04-05	430-13	460-48	Ally rear	520-114	HD	#	JTKKKX250C	#
KX250 F T6F-XAFB	06-10	1446-13	460-48	Ally rear	520-112	HD	#	JTKKKX250E	#
KX250 F YBF-YCF, 2DF	11-13	1446-13	460-50	Ally rear	520-114	HD	#	JTKKKX250F	#
KX250 R6F-R8F	06-08	565-13	460-51	Ally rear	520-116	HD	#	JTKKKX250D	#
KX450 F D6F-DFD	06-13	1565-13	460-50	Ally rear	520-114	HD	#	JTKKKX450A	#
<b>KTM MX</b>									
65 SX	04-11	1906-14	894-50		420-112	STD	JTKV SX65A	#	#
85 SX (LW)	05-12	1906-14	894-48		420-112	STD	JTKV SX65B	#	#
85 SX	04-12	1907-14	895-46		428-124	STD	JTKV SX85B	#	#
85 XC	08-09	1907-14	895-46		428-124	STD	JTKV SX85B	#	#
125 SX Motocross	95-11	1901-13	897-50		520-118	HD	#	JTKV SX125A	#

\* 513-15 = 566-15



Model	Year	Front	Rear	Notes	Chain	Manufacturers Recommended Chain Grade	STD	HD	O-RING
125 SX Motocross	12	TBC	TBC		TBC	TBC	TBC	TBC	TBC
125 EXC Enduro	04-10	1901-14	897-42		TBC	HD	#	JTKVEX125A	#
200 XC-W	06-12	1901-14	897-48		520-118	HD	#	JTKVXC2A	#
200 XCF-W	12	1901-13	897-50		520-118	HD	#	JTKVXC2B	#
250 SX Motocross	04-12	1901-13	897-48		520-116	HD	#	JTKVSX25A	#
250 SX-F Racing	06-12	1901-13	897-48		520-116	HD	#	JTKVSX25A	#
450 SX	09-11	1901-14	881-38		520-118	HD	#	JTKVSX45A	#
450 XC	08-11	1901-14	881-38		520-118	HD	#	JTKVSX45A	#
450 XC-W	12	1901-13	897-52		520-118	HD	#	JTKVSX45B	#
505 SX	09-11	1901-14	881-38		520-118	HD	#	JTKVSX45A	#
525 XC	08-11	1901-15	881-38		520-118	HD	#	JTKVXC52A	#

\* 513-15 = 566-15

**KTM MX cont...**

Model	Year	Front	Rear	Notes	Chain	Manufacturers Recommended Chain Grade	STD	HD	O-RING
<b>SUZUKI MX</b>									
JR50	83-06	563-13	1780-28		420-78	STD	JTKSJR50A	#	#
RM60 K3	03	546-13	464-44	Ally rear	420-104	STD	JTKSRM60A	#	#
RM65 K3-K5	03-05	546-13	1465-47	Ally rear	420-110	STD	JTKSRM65A	#	#
JR80	82-03	428-12	802-34		428-96	STD	JTKSJR80A	#	#
JR80	04-05	428-12	802-34		428-112	STD	JTKSJR80B	#	#
RM80 XK-K1	89-01	416-14	798-48	Ally rear	428-118	HD	#	JTKSRM80A	#
RM80 V-K1 (Big Wheel)	97-01	416-13	798-48	Ally rear	428-118	HD	#	JTKSRM80B	#
RM85 K2-L2	02-12	416-14	798-47	Ally rear	428-118	HD	#	JTKSRM85A	#
RM85 L K2-L2 (Big Wheel)	02-12	416-13	798-47	Ally rear	428-122	HD	#	JTKSRM85C	#
RM125 Y-K5	00-05	427-12	808-49	Ally rear	520-114	HD	#	JTKSRM125A	#
RM125 K6-K9	06-09	427-12	808-51	Ally rear	520-114	HD	#	JTKSRM125B	#
RM250 Y-K3	00-03	432-13	808-48	Ally rear	520-114	HD	#	JTKSRM250A	#
RM250 K4-K9	04-09	432-13	808-50	Ally rear	520-114	HD	#	JTKSRM250B	#
RM-Z250 K4-K6	04-06	430-13	460-48	Ally rear	520-114	HD	#	JTKSRMZ250A	#
RM-Z250 K7-K9	07-09	427-12	808-48	Ally rear	520-112	HD	#	JTKSRMZ250B	#
RM-Z250 L0-L2	10-12	427-13	808-49	Ally rear	520-114	HD	#	JTKSRMZ250C	#
RM-Z450 K5-K7	05-07	1441-14	808-49	Ally rear	520-116	HD	#	JTKSRMZ450B	#
RM-Z450 K8-L1	08-11	1441-13	808-50	Ally rear	520-114	HD	#	JTKSRMZ450A	#
RMX450 Z L0	10	1441-13	808-50	Ally rear	520-114	HD	#	JTKSRMZ450A	#
RMX450 Z L1, L2	11-12	1441-14	808-51	Ally rear	520-114	HD	#	JTKSRMX450A	#

Model	Year	Front	Rear	Notes	Chain	Manufacturers Recommended Chain Grade	STD	HD	O-RING
<b>YAMAHA MX</b>									
TT-R50 E-V,W,X,Y,Z,A,B	06-12	546-13	834-37		420-TBC	STD	JTKYTTR5A	#	#
PW80	91-11	546-15	834-32		420-84	STD	JTKYPW80A	#	#
YZ85 P,R,S,T,V,W,X,Y,Z,A	02-11	558-14	798-47	Ally rear	428-118	HD	#	JTKYYZ85A	#
YZ85 P,R,S,Y,V Large Wheel, T,W,X,Z,A,B	02-12	558-14	798-52		428-124	HD	#	JTKYYZ85B	#
TT-R90	00-04	546-14	834-35		420-86	STD	JTKYTTR9B	#	#
TT-R90 E	04-07	546-14	834-35		420-86	STD	JTKYTTR9B	#	#
TT-R110 E	08-12	546-14	834-35		420-90	STD	JTKYTTR110A	#	#
TT-R125	00-01	548-13	833-49		428-116	HD	#	JTKYTTR125A	#
TT-R125	02-04	548-13	1843-49		428-116	HD	#	JTKYTTR125B	#
TT-R125 E	05-10	548-13	1843-49		428-116	HD	#	JTKYTTR125B	#
TT-R125 LW	02-04	548-13	1843-54		428-122	HD	#	JTKYTTR125C	#
TT-R125 L-LWE	05-12	548-13	1843-54		428-122	HD	#	JTKYTTR125C	#
YZ125 P,R,S	02-04	564-13	251-49	Ally rear	520-112	HD	#	JTKYYZ125A	#
YZ125 T,V,W,X	05-08	1590-13	251-48	Ally rear	520-112	HD	#	JTKYYZ125B	#
YZ125 Y,Z,A1	09-11	1590-13	251-48	Ally rear	520-114	HD	#	JTKYYZ125C	#
TT-R230	05-12	1554-13	251-49	Ally rear	520-106	HD	#	JTKYTTR23A	#
WR250 F-L,M	99-00	565-14	251-50	Ally rear	520-114	O-RING	#	JTKYWR426A	#
WR250 F-N-V (Off Road)	01-06	1590-13	245/2-52	Gear change	520-114	O-RING	#	JTKYWR250B	#
WR250 F-W-Z (Off Road)	07-10	1590-13	251-50	Ally rear / Gear change	520-114	O-RING	#	JTKYWR250A	#
YZ250 P,R,S	02-04	565-14	251-49	Ally rear	520-114	HD	#	JTKYYZ250A	#
YZ250 T,V,W,X,Y,Z,A1	05-11	565-14	251-50	Ally rear	520-114	HD	#	JTKYYZ250D	#
YZ250 F-N,P,R,S (4 Stroke)	01-04	1590-13	251-48	Ally rear	520-112	HD	#	JTKYYZ250B	#
YZ250 F-T,V,W,X,Y (4 Stroke)	05-09	1590-13	251-49	Ally rear	520-112	HD	#	JTKYYZ250C	#
YZ250 F-Z (4 Stroke) A,B	10-12	1590-13	251-51	Ally rear	520-114	HD	#	JTKYYZ250E	#
WR400 F-L-N	99-01	565-14	251-50	Ally rear	520-114	O-RING	#	JTKYWR400A	#
WR426 F-N/P	01-02	565-14	251-50	Ally rear	520-114	O-RING	#	JTKYWR426A	#
YZ426 F-M,N,P	00-02	565-14	251-48	Ally rear	520-114	HD	#	JTKYYZ426A	#
WR450 F-R,S,T,V	03-06	565-14	251-50	Ally rear	520-114	O-RING	#	JTKYWR426A	#
WR450 F-W,X,Y,Z	07-10	565-13	251-50	Ally rear	520-114	HD	#	JTKYWR450A	#
YZ450 F-R,S	03-04	565-14	251-48	Ally rear	520-114	HD	#	JTKYYZ450A	#
YZ450 F-T,V	05-06	565-14	251-51	Ally rear / Gear change	520-114	HD	#	JTKYYZ450B	#
YZ450 F-W,X,Y,Z,A	07-12	565-13	251-49	Ally rear	520-114	HD	#	JTKYYZ450C	#

\* 513-15 = 566-15



## Armstrong HH Off-Road Disc Pads

As used by Monster Energy Yamaha Racing MX Team, Armstrong Racing Off-Road disc pads utilise a sintered compound offering optimum properties at high and low speeds in off-road conditions, with excellent heat resistance and durability. Fully TUV approved and at competitively priced, the Armstrong HH Off-Road range is one that should be stocked with confidence.



**Developed & Used By  
Monster Energy Yamaha  
Racing MX Team**

Cross Reference Guide			Armstrong
<b>VESRAH</b>	<b>FERODO</b>	<b>EBC</b>	<b>HH Off-Road</b>
VD120	FDB250	FA54	<b>PAD990044</b>
VD325	FDB314	FA67	<b>PAD990057</b>
VD339	FDB313	FA83	<b>PAD990073</b>
VD128	FDB381	FA84	<b>PAD990074</b>
#	#	FA86	<b>PAD990076</b>
VD134	FDB382	FA92	<b>PAD990082</b>
#	#	FA95	<b>PAD990085</b>
VD239	FDB383	FA101	<b>PAD990091</b>
#	#	FA115	<b>PAD990105</b>
VD-244	FDB453	FA119	<b>PAD990109</b>
#	#	FA125	<b>PAD990115</b>
#	#	FA130	<b>PAD990120</b>
VD-144	FDB539	FA131	<b>PAD990121</b>
VD-340	FDB497	FA135	<b>PAD990125</b>
#	#	FA142	<b>PAD990132</b>
VD-432	FDB	FA152	<b>PAD990142</b>
VD-947	FDB2039R	FA181	<b>PAD990171</b>
VD-161	FDB892	FA185	<b>PAD990175</b>
VD-340	FDB497	FA202	<b>PAD990125</b>
VD-953	FDB2019	FA208	<b>PAD990198</b>
VD-953	FDB2019	FA213	<b>PAD990198</b>
VD-340	FDB497	FA228	<b>PAD990125</b>
VD-351	FDB	FA230	<b>PAD990220</b>
VD-438	#	FA258	<b>PAD990248</b>
#	FDB2110	FA302	<b>PAD990292</b>
#	#	FA325	<b>PAD990315</b>
#	#	FA337	<b>PAD990327</b>
#	FDB2139	FA346	<b>PAD990336</b>
#	FDB2157	FA357	<b>PAD990347</b>
#	FDB2162	FA367	<b>PAD990357</b>
#	FDB2165	FA368	<b>PAD990358</b>
VD-161	FDB892	FA389	<b>PAD990175</b>
VD358	FDB2197	FA401	<b>PAD990391</b>
#	#	FA450	<b>PAD990440</b>
#	#	FA602	<b>PAD990592</b>
#	#	FA612	<b>PAD990602</b>

Armstrong Racing Disc Pads are proud OEM product sponsor to the Bike It Cosworth Yamaha Racing MX team in the FIM World MX Championship in both MX1 and MX2 classes.

## Armstrong ATV Discs Pads

Armstrong disc pads specific for off-road ATV use. A sintered compound offering great braking in off-road conditions

Order Code	EBC	VESRAH	Order Code	EBC	VESRAH	Order Code	EBC	VESRAH
<b>PAD550008</b>	FA018	VD907	<b>PAD550125</b>	FA135	VD340	<b>PAD550261</b>	FA271	#
<b>PAD550044</b>	FA054	VD120	<b>PAD550155</b>	FA165	VD250	<b>PAD550297</b>	FA307	#
<b>PAD550073</b>	FA083	VD339	<b>PAD550260</b>	FA270	#	<b>PAD550406</b>	FA416	#
<b>PAD550074</b>	FA084	VD128						



## Garage Pit Mat

- Heavy Duty nylon fibred mats with oil and water-resistant non-slip backing
- Striking colour-coded designs to compliment all brands of bikes
- Used in workshops, home garages and at tracks, offers anti-fatigue protection when working around the bike and protects ground surface from drips and spills
- Maximises bike-displays in showrooms

<i>Order Code</i>	<i>Colour</i>
<b>GRGMAT29</b>	Blue
<b>GRGMAT30</b>	Green
<b>GRGMAT31</b>	Orange
<b>GRGMAT32</b>	Red
<b>GRGMAT33</b>	Yellow



## Garage Mats - Logo Series 2

New range of bold and striking garage mats, in factory colour-coded designs

Garage mats can be used for decoration and display purposes in home garages and dealer showrooms

Mats also function as protective work-mats both indoors and outdoors, preventing fuel and lubricant spills on the floor when carrying out maintenance and repairs

Each mat is constructed with nylon-fibred mat top section which is oil and water resistant, and features a non-slip backing

Size 183cm x 75cm

<i>Order Code</i>	<i>Description</i>
<b>GRGMAT21</b>	Honda
<b>GRGMAT22</b>	Kawasaki
<b>GRGMAT25</b>	Suzuki Blue
<b>GRGMAT26</b>	Suzuki Yellow
<b>GRGMAT28</b>	Yamaha



## Pro Filter Cleaning Kit

### FOAM FILTER CLEANING KIT

Filter Kit includes everything you need to clean and prepare foam filters.. The kit contains: 5 LTR PRO FILTER • DIRT CATCHING TRAY • FILTER PREP BUCKET • HEAVY DUTY NITRILE GLOVES • All contained in a 20 LTR CLEANING BUCKET



Order Code: **PCNFK1**

## Pro Clean Race Pack

Replacing the "Buc - Kit", the Pro Clean Race Pack is bigger and better than ever before, but keeps its affordable price tag. Perfect for those who are new to the Pro Clean range, or a great gift to anyone who already uses the products. The kit contains: 1 LTR PRO CLEAN • 400ml SUPER LUBE • 400ml CHAIN LUBE • 400ml DE GREASER • 250ml TYLE LUBE • 500ml HAND SCRUB • BIG HANDFUL SPONGE • DETAIL BRUSH • CHAMOIS

Order Code:  
**PCNRP1**





**PRO-CLEAN** has been the market leader of motorcycle cleaning and maintenance products in the UK and Europe for over fifteen years. We are continuously challenged to develop the best complete range of products by the many top-flight teams who use the range, but still keep an affordable price tag.

The exciting news is that **PRO-CLEAN** is now DEVELOPED FOR YOUR SPORT. This has been achieved by working closely with some of the biggest names in each discipline. Which ever your ride of choice, there is now a range of products for you.

All you need to do is go out and get dirty!



### Pro Clean

DEVELOPED FOR YOUR SPORT

Pro-Clean is a unique blend of fully biodegradable chemicals designed to clean every part of the exterior of your race machine.

The intelligent chemical formulation releases the correct level of active cleaning agents to ensure perfect results every time from mud covered rally cars to the most refined precious metals and carbon fiber components of delicate racing cycles.

Order Code	Description
<b>PCNPCL1</b>	1 Litre
<b>PCNPCL5</b>	5 Litre
<b>PCNPCL25</b>	25 Litre



### Pro Care

DE WATERING, ANTI RUST TREATMENT

Pro-Care is a blend of lubricants and low evaporation penetrating oils designed to displace water from the hidden places where rust and corrosion may occur between washes and after poor weather.

Order Code	Description
<b>PCNPCR1</b>	1 Litre
<b>PCNPCR5</b>	5 Litre
<b>PCNPCR25</b>	25 Litre



### Pro Tecton

WATER BASED CORROSION INHIBITOR

Pro Tecton is completely unique & revolutionary water based corrosion inhibitor, which leaves a microfilm coating designed to protect against road salt, rust and general corrosion attacks from the elements.

Pro Tecton can be sprayed safely over any surface. Once dry it leaves a molecular film, which protects the treated surface. Pro Tecton does not affect brake discs or other brake components.

Order Code	Description
<b>PCNPTN1</b>	1 Litre
<b>PCNPTN5</b>	5 Litre



### De Greaser

HIGH POWER DE GREASING AGENT

Degreaser is a specially designed and blended formulation, perfectly balanced to remove grease and dried oil build up on chains, sprockets, spindles, engines etc. Heavily soiled components can be immersed in the De Greaser fluid and left until corrosion and soiling is removed from the surface.

Order Code	Description
<b>PCNDGR1</b>	1 Litre
<b>PCNDGR5</b>	5 Litre



### Pro Filter

FAST ACTING FOAM FILTER CLEANER

Pro-filter is another favorite and one of our best sellers. Pro-Filter is designed to remove dirt and tacky oil from all types of foam air filters. Simply immerse the dirty filter in the solution and squeeze gently to remove the tacky oil, then wash the filter in a bucket of warm water with a splash of Pro-Clean to remove any remaining dirt or dust, finally dry thoroughly before re-using the filter.



Order Code	Description
<b>PCNPFT5</b>	5 Litre

### Grip Lock

NON-ADHESIVE GRIP FITTING SPRAY

Grip Lock is a trick new product from the Pro-Clean lab. It's unique non adhesive formula is specifically designed to take the effort out of fitting new grips to motorcycles, quads and mountain bikes.



Using Grip Lock couldn't be easier. Simply hold the can approximately 50mm from the neck of the grip and apply one short burst, slide the grip onto bars and adjust into position. The grip is locked in just a few minutes making the task of changing grips not only clean, but easy.

Grip Lock leaves no sticky residue on the bar and when the grip is eventually replaced, a new one can be fitted in seconds.

Order Code	Description
<b>PCNGLA070</b>	70 ml

### Mega Spray

EXTENDING TRIGGER SPRAY

AVAILABLE FOR: 5 LTR CONTAINERS

Mega Spray is an extending trigger for the 5 Ltr containers allowing the user to simply carry and spray.



Order Code:
<b>PCNMGS</b>

## Mousse Lube

LOW FRICTION, HIGH HEAT TOLERANCE  
MOUSSE LUBE

Mousse Lube was introduced to our product range in 2007 on the request of our UK Distributors. Mousse Lube has been extensively tested by top Paris-Dakar test riders in Sahara temperatures in excess of 43 degrees Celsius and also by the top UK GP Motocross and Enduro teams with excellent results. This is fast becoming one of our best selling products. If you know how to fit a mousse you will know how to use the lube.

Order Code	Description
<b>PCNML250</b>	250ml
<b>PCNML250WS</b>	2.5 Litre



## Hand Scrub

ADVANCED FORMULA HAND CLEANER

Hand Scrub is a superior hand cleaning gel containing polymer beads, sanitizer and moisturizers to ensure clean and protected hands.

Order Code	Description
<b>PCNHS500</b>	500ml



## Anti-Fling Chain Lube

HIGH POWER CHAIN LUBE

This high performance chain lube is a scientifically designed for all Open chains as well as O and X ring plus the latest Z ring chains.

The formulation of the lubricant allows for the penetration of the inner roller area and prevents throw-off at high speed. Clear polymer chain lube protects against corrosion, reduces power loss and is proven to prolong chain and sprocket life.

Order Code	Description
<b>PCNCLA400B</b>	Aerosol, 400ml



## Chain Lube (Aerosol)

CLEAR POLYMER CHAIN LUBE

This high performance chain lube is a scientifically developed lubricant designed for all open chains.

The formulation of the lubricant allows for the penetration of the inner roller area and prevents throw-off at high speed. Clear polymer chain lube protects against corrosion, reduces power loss and is proven to prolong chain and sprocket life.

Order Code	Description
<b>PCNCLA400</b>	Aerosol, 400ml



## Tyre Paste

Universal tyre paste for quick and easy mounting and demounting of tyres. Non-staining, protects beads and rims.



Order Code	Description
<b>PCNTP5</b>	5kg

## Tyre Lube

NON RESIDUE, LOW FRICTION TYRE FITTING GEL

Tyre Lube...Tyre fitting with ease!

This revolutionary tyre fitting gel takes all the effort out of fitting a tyre. Tyre Lube leaves no unsightly paste stains and the tyre slips on quickly and easily. The unique quick drying, non-corrosive formulation is perfectly safe on all types of tyres and rims.

Order Code	Description
<b>PCNTL250</b>	250ml
<b>PCNTL25WS</b>	2.5 Litre



## Super Polish

SILICONE FREE NON ABRASIVE POLISH

Super Polish is a rich non abrasive silicone free polish designed to work on all surfaces including plastic, paintwork and aluminium leaving a superb gloss finish. Simply apply to a small area at a time with a dry lint free cloth and buff to brilliant shine. Avoid contact with grip surfaces of seat covers as polish is difficult to remove from grained surfaces.

Order Code	Description
<b>PCNSP500</b>	500ml



## Super Lube (Aerosol)

DE WATERING, ANTI RUST SPRAY

This superior grade maintenance spray is a heavy duty multi purpose spray designed to displace and repel moisture from moving parts and electrical apparatus, helps protect against rust and corrosion, lubricates and releases seized metal components.

Super Lube leaves a light protective lubricant film on surfaces ensuring prolonged anti moisture protection.

Order Code	Description
<b>PCNSLA400</b>	Aerosol, 400ml



## Pipe Gel

REMOVES RUST AND CORROSION FROM 2 STROKE PIPES

Pipe Gel is specifically designed to remove rust and corrosion from untreated steel race pipes.

The pipe must be removed from the machine prior to the application of Pipe Gel as it will cause damage if in contact with aluminium surfaces.

Pipe Gel is brush applied and goes to work immediately dissolving rust and corrosion, agitate gently if required, leave for a few minutes then simply wipe away with industrial paper towel or wash off with clean water.

Order Code	Description
<b>PCNPG250</b>	250ml



## Kit Wash

WASHING MACHINE SAFE RACE KIT CLEANER

Kit Wash is a formulation based on Pro-Clean but with low foam and material friendly additives to make it the ideal solution for race kit washing.

Complete with a measuring cap just pour a couple of shots directly into the washing machine drum, add fabric conditioner as you would for a normal cycle and wash at 30 degrees. Not suitable for road leathers.

Order Code	Description
<b>PCNKW500</b>	500ml



## De Greaser (Aerosol)

HIGH POWER CLEANER DE GREASER

Aerosol De Greaser is a fast acting quick drying cleaner/degreaser specially designed for the fast and easy removal of grease and oil deposits on discs, chains, sprockets, engines etc, when the need to remove grease is immediate.

Aerosol degreaser is completely safe on discs and all braking components, leaves no residue and dries instantly.

Order Code	Description
<b>PCNDGA400</b>	Aerosol, 400ml





## Mammoth Lock & Chain

- 12mm square link Cr-Mo steel chain
- Available in 1.8m and 1.2m chain length.
- Hardened steel lock body with double bearing lock mechanism
- 11mm hardened Cr-Mo steel closed U-shackle
- Reinforced cylinder plates resist drilling and picking



### When to use:

Designed for all securing needs, especially suited to secure a motorbike to a fixing such as ground anchor, lamp post etc.

Order Code	Length
LOCM003	1.8m
LOCM007	1.2m

### Mammoth Rated



This Mammoth security product has been evaluated against "The British Insurance Industry's Criteria for Vehicle Security", using specific tests to indicate the effectiveness of the product. It is recognised as a Thatcham 'Approved Device' Category 3 Mechanical Immobiliser. Thatcham Evaluation number TMC3-303-1207

## Garage Guard

- Remote PIR Alarm
- Keypad controlled alarm
- Activates when movement detected
- 2 Keyfob Remote Controls
- Entry / Exit delays
- Piercing 105dB alarm sound
- Wall mounted OR Stand alone
- Battery Operated

Order Code:  
ALAGRG01



Battery operated motion sensor alarm, perfect for use in garages or sheds.

## Bolt-In Ground Anchor

- Heavy-Duty ground anchor
- Simply bolts into concrete surface
- Manufactured from hardened steel
- Twin layer design feature, increases protection
- Suitable for outdoor and indoor use

### Kit includes;

- 1 x Ground Anchor Unit
- 4 x M10 Expander Allen Head Bolts
- 4 x Anti-Tamper Bearings
- Instruction Guide

Order Code:  
GRD001



### Mammoth Rated



This Mammoth security product has been evaluated against "The British Insurance Industry's Criteria for Vehicle Security", using specific tests to indicate the effectiveness of the product. It is recognised as a Thatcham 'Approved Device' Category 3 Mechanical Immobiliser. Thatcham Evaluation number TMC3-317-0310

## Mammoth U-Lock

Premium quality U-Lock  
 Extremely robust body for maximum theft deterency  
 16mm hardened steel shackle with rubberised protective coating  
 Double locking mechanism bar  
 Weatherproof key cover  
 125mm width (87mm internal) x 300mm length (internal)

### When to use:

Intended as an additional or short-term security device.  
 U-Locks are ideal for use when a lock and chain cannot be used, such as on journeys when it is difficult to carry a heavy device – compact and light enough to store in panniers, tailbags and top-boxes. U-locks should be inserted through wheels, discs and forks, making it more difficult for would be thieves to wheel a bike away. Also use as additional security whenever the bike is chained to a permanent fixing.

Order Code: LOUM012

### Mammoth Rated



## Loop & 'U' Cable Lock

Cable locks offer the same functionality as lock and chains, but with the advantage that the lock head is integrated on the cable end. Use to lock motorcycles to ground anchors and other security points.

### INTEGRATED DISC LOCK

- Integrated mini U-lock allows disc lock function
- Fully rotating for ease of use
- Weatherproof barrel cover
- 14mm covered hardened steel shackle

### CABLE LOCK

- Woven hardened steel cable with protective outer sleeve (14mm)
- Outer sleeve protects paintwork and rims
- 1.6m cable
- Loop end allows 'noose' function for versatile locking options

Order Code: LOCSU65

### Mammoth Rated



## X-Line Cable

The X-Line is a versatile cable that should be used with other security products as an extender or to loop around anchor points. USE WITH SHACKLE LOCKS, PADLOCKS and U-LOCKS

- Reinforced steel cable with protective sleeve (6mm)
- Outer sleeve protects paintwork and rims
- 1.8m recoiling cable
- Looped ends

### Mammoth Rated



Order Code: LOCXLIN



Use as an extension cable with other security products including U-locks, cable locks and lock and chain.

## Mammoth Lock & Chain

10mm square link hardened steel chain.  
 Hardened steel lock body with double bearing lock mechanism.  
 11mm hardened steel closed U-shackle.  
 Drill and pick resistant lock.  
 Bright green fabric sleeve acts as visual deterrent, protects wheels and paintwork.

### When to use:

Designed for all securing needs, especially suited to secure a motorbike to permanent fixing such as ground anchor, lamp post etc.

Order Code Length  
 LOCM009 1.8m

### Mammoth Rated





## BikeTek Lap Timer

- > Laptimer with wireless I.R transmitter
- > A simple and reliable lap-timing unit for all race and practice purposes
- > Compact and lightweight design, the LCD-display receiver is easily mounted to road and off-road motorcycles, karts, cars and cycles
- > Pitwall transmitter unit, powered by two AA batteries (not included)
- > 15 metre range (transmitter<->receiver)
- > Memory capacity of 64 laps / 99 minutes
- > 65x40x11mm receiver unit with wired IR-eye
- > Viewable data; individual lap timings : slowest lap : fastest lap : total time : average lap time
- > 40x20mm LCD display
- > 940nm frequency

Order Code: **TIM011**



## BIKETEK

The receiver should be mounted to the vehicle in an appropriate position which does not interfere with vehicle functioning (self-adhesive velcro mount included).

When the receiver (fitted to the vehicle) passes by the I.R transmitter (left in a suitable location such as pitwall) the lap number is displayed and time is recorded, building up data of lap splits.

If multiple Biketek laptimers are in use in the same session, just one transmitter should be used (ensure no more than one transmitter is in use).

It is the user's responsibility to ensure that laptiming devices are authorised for use at the track / circuit.

## Pit Board

Reversible pit board.

- Blackboard on front, whiteboard on reverse
- Dual aspect handles for easy reverse handling
- Made from tough, durable material
- Approximate Size: 55cm x 40cm

Order Code: **PITB01**



Black side



White side

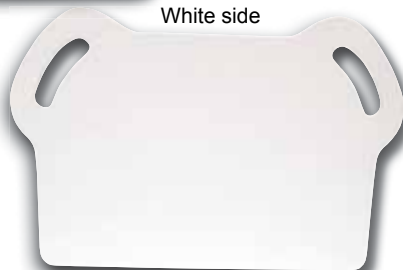

## Motorsports Stopwatch

Professional sports timing unit.

Includes all features needed for professional time management and logging.

- 1/100th precision STOPWATCH
- 10 hour timing capacity
- 50 lap memory
- Average, Fastest and Slowest laps display
- Count-up / count-down timer with repetition counter
- Pace alarm
- 12/24HR Time and Calendar displays, with alarm
- LCD "in-focus" display
- Ergonomic shell with neckstrap
- Water and Shock resistant

Order Code:  
**LCDSTP01**



## Easy-Up Gazebos

Free-standing gazebos for occasional use, ideal for weekend track use whether off-road or tarmac, provides a sheltered area for rest and working on bikes. Scissor-style powder coated steel frame allows for simple and quick set-up. Height adjustable support legs, peaked roof prevents rain water build up. Strong waterproofed nylon fabric roof.

Each gazebo is supplied as a frame and roof-only format. Side walls are available to purchase separately, attaching to the roof structure by robust velcro trims.

Order Code	Description
<b>GAZ002</b>	3x3m square gazebo frame and roof
<b>GAZ004</b>	3m width side wall for GAZ002 (1pc)
<b>GAZ006</b>	3m diameter hexagon gazebo frame and roof
<b>GAZ008</b>	2m width sidewall for GAZ006 (1pc)



## Event / Workshop Table

Versatile blown plastic moulded table with folding feature. Ideal for additional work space in workshops and outdoor events.

Size: 1830mm x 760mm x 740mm (open)  
Order Code: **CHREVT04**



## Reflective Over Jacket

A superior high visibility product, the 3/4 length sleeves offer additional safety and visibility, especially from the side and in heavy traffic. Features white reflective crystalline tape as used by the British police and emergency services.

- Features:
- Generous cut
  - Zip front
  - Hi-Vis reflective crystalline tape
  - 3/4 Length sleeves
  - Lightweight - fits over existing clothes
- One size fits all.

Order Code:  
**REFJACK**



## Reflective Bib Vest

High visibility bib-vest for increased safety. Bright colours and reflective tape helps other road users see riders both day and night.

- Features:
- Generous cut for comfort
  - Strong zip fastening front
  - EN471/EN340 "Hi-Vis" tape
- One size fits all.

Order Code Description  
**REFVEST** Yellow  
**REFVORG** Orange



## Air Horn

The race day necessity!  
Loud air horn. New hand pump type requires no gas

Order Code:  
**AIR001**



## Quick-Up Awnings

These robust free-standing canopies are ideal for any outdoor events including race days and retail shows. Extremely easy to set up, the awning has removeable side walls to protect people and belongings from the elements. A perfect base set up in minutes.

- Powder coated steel frame (30\*30mm)
- Peaked roof for water drainage
- Quick set-up canopy
- Height adjustable upright posts
- Roof and sidewalls 420D PU coated poly fabric
- Sidewalls include windows on 2 sides
- Waterproof, fire retardant and UV protective
- Sidewalls attach to roof with velcro, & zip together for optimum stability
- Light and portable carry bags for sidewalls and frame

Order Code	Description
<b>AWN001</b>	3 x 3m Quick-Up Awning Red
<b>AWN002</b>	3 x 6m Quick-Up Awning Red



Main picture: 3m x3m. Inset picture 6m x 3m

Guy rope attachment



Quick-Up canopy





Item	Page No.
<b>A</b>	
Air Filter Cleaner	51
Air Filters	51
Air Horn	71
Allen Keys	39
Armour - Adult	29
Armour - Youth	33
Armstrong Pads	64
Awning	71
Axle Bolt	41
Axle Spanners	41
Axle Stand	9
<b>B</b>	
Back Protector	30
Backgrounds	35
Bar Clamps	23
Bar Ends	16-17
Bar Mounts	16-17
Bar Pads	16
Bar Risers	16
Bar Straps	44
Bars	17
Bead Breaker	41
Bead Clamp	40
Bearing Packer	36
Bolt Kits	46
Boots - Adult	31
Brake Bleeders	42
Brake Caliper Tool	36
Brake Disc - Front	55-56
Brake Disc - Rear	57
Brake Disc Pads	64
Brake Levers	19-22
Brake Pedals	5
Brush Guards	18
Brushes	42
Bum Bag	27
<b>C</b>	
Cable Lock	69
Cable Lubricators	38
Cable Repair Kit	38
Care Products	45
Chain	58-59
Chain & Sprocket Kits	60-63
Chain Alignment	39
Chain Breakers	39
Chain Brush	39

Item	Page No.
Chain Cleaner	45
Chain Cleaning Kit	39
Chain Lube	45
Chain Pliers	39
Chain Rollers	24
Clean Grips	15
Cleaning Brushes	42
Cleaning products	45
Clutch Boots	6
Clutch Levers	19-22
Cotter Pins	46
<b>D</b>	
Disc Pads	64
Donuts	15
Duct Tape	47
Dust Caps	53
<b>E</b>	
Elbow Pads	31
Exhaust Bung	14
Exhaust Packing	14
Exhaust Shields	14
Exhaust Springs	14
Exhaust Wrap	35
Exhausts	13-14
<b>F</b>	
Fairing Headlights	10-11
Fat Bars	17
Feeler Gauges	41
Flywheel Pulley	37
Foam Guard	24
Foot Pegs	3
Foot Pump	41
Footpeg Gaitors	3
Fork Air Bleeders	6
Fork Gaitors	6
Fork Oil Adjuster	36
Fork Oil Seal Driver	36
Fork Seals	49
Fork Stroke Indicators	49
Fork Supports	44
Fuel Caps	24
Fuel Filters	48
Fuel Hose	48
Fuel Jug	43
Fuel Line Couplers	48
Fuel Mix Screw	48
Fuel Mixing	43

Item	Page No.
Fuel Syphon	43
Fuel Tank	43
Fuel Taps	48
Funnel	43
<b>G</b>	
Garage Alarm	68
Garage Mats	65
Gazebo	71
Gear Pedals	5
Gloves - Adult	27
Gloves - Latex	45
Gloves - Mechanic	45
Gloves - Youth	34
Goggle Bag	26
Goggles - Adult	27-28
Goggles - Youth	32
Grip Donuts	15
Grip Glue	15
Grip Sleeves	15
Gripper Tank Pads	35
Grips	15
Ground Anchor	68
<b>H</b>	
Handlebars	17
Hardware Kits	46
Headlights	10-11
Heat Shield	35
Helmet Carrier	26
Helmet Liner	25
Helmet Liner	31
Helmets - Adult	25
Helmets - Youth	32
Hour Meters	48
H-Stand	9
Hydration Bag	26
<b>I</b>	
Inner Tubes	53
<b>J</b>	
Jacket Protector - Adult	29-30
Jerry Cans	43
<b>K</b>	
Kickstands	6
Kidney Belt - Adult	31
Kidney Belt - Youth	33
Kill Switches	48
Kit Bag	26
Kit Cart	37

Item	Page No.
Knee Pads - Adult	31
Knee Pads - Youth	33
Kneeling Pads	38
<b>L</b>	
Lap Timer	70
Latex Gloves	45
Lever Assemblies	22
Lever Bracket Sleeves	23
Lever Mounts	22
Lever Sleeves	23
Levers	19-22
Lift Stand	9
Loading Ramps	7
Lock & Chain	68-69
Lock Wire	38
Lock Wire Washers	38
<b>M</b>	
Magnetic Dish	38
Mammoth Locks	68-69
Mechanic Gloves	45
Mirror	17
Mud Remover	6
<b>N</b>	
Neck Brace - Adult	31
Neck Brace - Youth	33
Neck Tubes	31
Neo Palm Pads	28
Numbers	35
<b>O</b>	
Oil Filters	50
Oil Funnel	43
Oil Pans	43
Oil Seal Puller	37
<b>P</b>	
Palm Saver	28
Pedals - Brake	5
Pedals - Gear	5
Pick Set	37
Pit Board	70
Pit Mats	65
Plug Caps	52
Plug Holder	41
Power Washer	42
Pressure Gauge	41
Pro Clean	65-67
Protector Shorts	30

Item	Page No.
<b>R</b>	
Race Numbers	35
Ramps	7
R-Clips	46
Reflective Vest	71
Ridge Stand	9
Rim Bolts	24
Rim Lock Nuts	24
Rim Protectors	40
Rim Tapes	53
Rotor Bolts	47
<b>S</b>	
Scissor Lift	8
Scrapers	37
Security	68-69
Security Bolts	24
Shock Wrench	36
Shorts	30
Socks	31
Spark Plug sockets	41
Spark Plug Tools	41
Spark Plugs	52
Spoke Wrench	40
Spring Hook	38
Sprocket Bolts	47
Steering Cup Remover	36
Stem Nuts	4
Stopwatch	70
Switches - Kill	48
Syringe	36
<b>T</b>	
Table	71
Tank Pads	35
T-Bars	38
Tear Offs - Kids	32
Throttle Sleeves	23
Tiedown Shrouds	44
Tiedown Straps	44
Tirox	39
Tool Boxes	37
Tool Chest	37
Tool Roll	27
Track Coat	30
Triangle Stand	9
Triple-S Chain	58-59
Two Bros Exhausts	13
Tyre Changer	41

Item	Page No.
Tyre Crush	40
Tyre Levers	40
Tyre Paste	40
Tyres - ATV	54
Tyres - MX	53
<b>U</b>	
U-Lock	69
<b>V</b>	
Valve Puller	40
Valve Tool	40
Viper Exhausts	14
<b>W</b>	
Waist Bag	27
Washers	47
Wheel Bag	53
Wheel Brush	42
Wheel Chock	8
Wheel Stripes	53
Wire Pliers	38
Wrenches	37
<b>Y</b>	
Y-Bars	38